

THE YOUNG DELINQUENT

---

CYRIL BURT

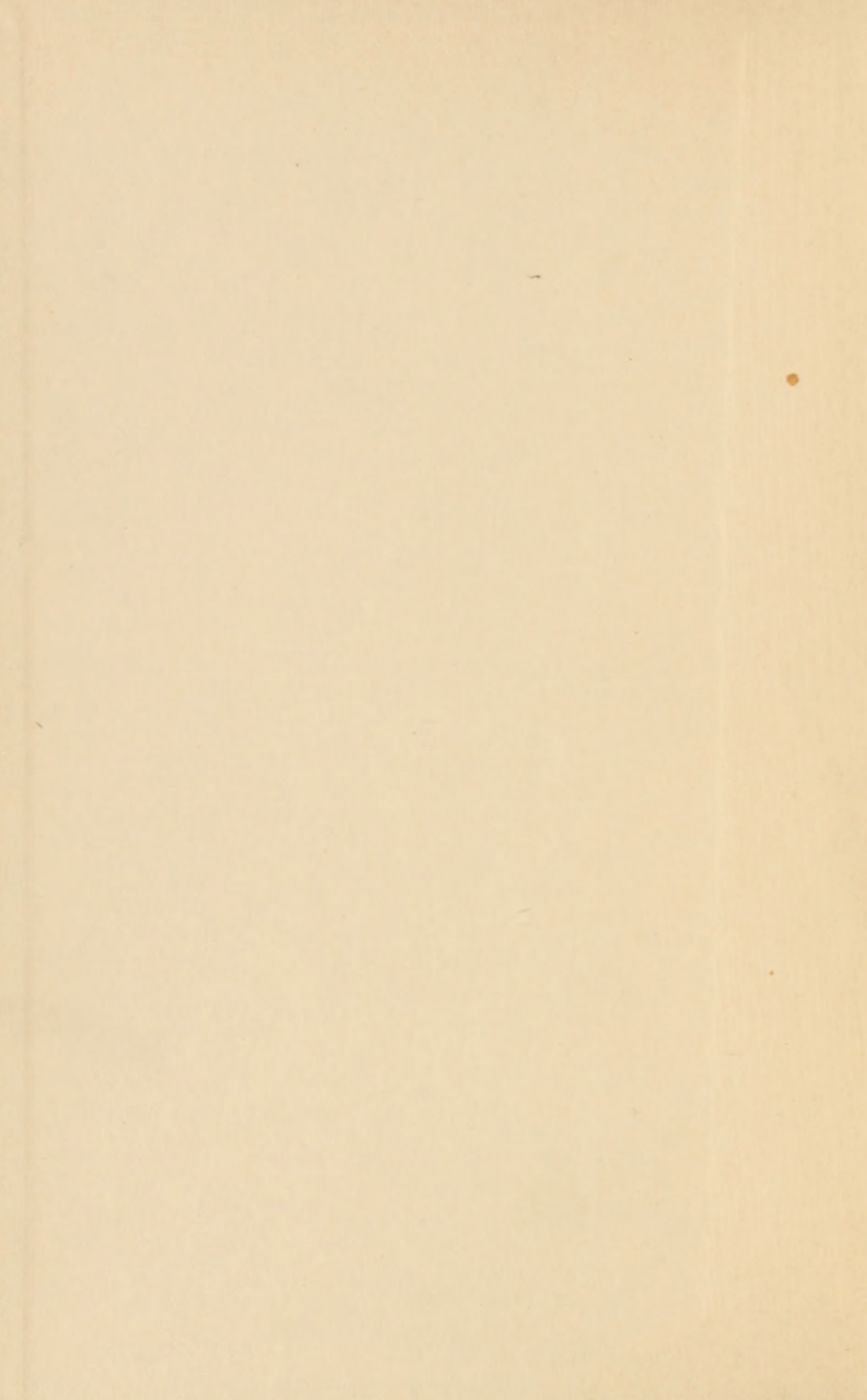







Digitized by the Internet Archive  
in 2010

THE  
YOUNG DELINQUENT







Fig. 1. "B. I", AGED 15 $\frac{1}{2}$

(See page 589)



# THE YOUNG DELINQUENT

BY

CYRIL BURT, M.A., D.Sc. (OXON.)

PROFESSOR OF EDUCATION IN THE UNIVERSITY OF LONDON;  
PSYCHOLOGIST IN THE EDUCATION DEPARTMENT OF  
THE LONDON COUNTY COUNCIL; AUTHOR  
OF "MENTAL AND SCHOLASTIC TESTS"

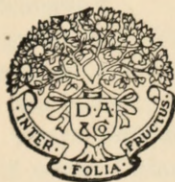

NEW YORK  
D. APPLETON AND COMPANY

1930

THE  
YOUNG DELINQUENT

CYRIL BURT, M.A. (OXF.)

LECTURER IN PSYCHOLOGY IN THE UNIVERSITY OF LONDON  
AND IN THE UNIVERSITY OF EDINBURGH  
AND IN THE UNIVERSITY OF MANCHESTER

COPYRIGHT, 1925, BY  
D. APPLETON AND COMPANY



D. APPLETON AND COMPANY

PRINTED IN THE UNITED STATES OF AMERICA

## PREFACE

THE problem of this book is the psychology of juvenile crime. The volume is one of a projected series of three, which together are designed to cover the main forms of mental subnormality to be met with among the young.

There is an old tripartite division of the mind, which distinguishes, as relatively independent aspects of our common conscious life, intelligence, emotion, and character. It views a human being as one who knows, and feels, and wills. In considering, therefore, children whose minds are subnormal, it becomes convenient to recognize three classes or types: first, those who are subnormal intellectually; secondly, those who are subnormal emotionally; and, thirdly, those who are subnormal in morality and character—or, in single words, the backward, the unstable, and the delinquent.

Of the backward, together with the dull and the defective, and of the unstable, together with the nervous or neurotic, I propose to treat in the two volumes to follow. In this I have limited myself, except where different defects are combined and overlap, to the child whose failings are moral. So far as is possible, I intend to examine, in plain and popular language, the causes of youthful delinquency and the more effective ways of treating it.

Delinquency I regard as nothing but an outstanding sample—dangerous perhaps and extreme, but none the less typical—of common childish naughtiness. Just as the study of the mentally deficient has advanced both our knowledge and our teaching of the average boy and girl, just as the study of the hysterical has explained much that was unintelligible in everyday behavior, so, I am convinced, the psychology of the young criminal will throw great light upon the daily disciplinary problems of the classroom and upon the conduct or misconduct of the difficult child.

Crime may be rare, but naughtiness is universal. And the problems of character training are, or should be, the concern of all. Hence throughout these pages the argument is addressed, not so much to the lawyer, the psychologist, or the medical man, as to teachers and social workers, and indeed to all who, whether as parents or as enlightened members of the general public or as both, are interested in the moral welfare of young people and are influencing, by their active or inactive attitude, the progress of educational reform.

The substance of these chapters was originally delivered as a course of lectures to London teachers, and both style and matter doubtless still retain some echo of the lecture hall—here and there an anecdote, a reiterated platitude, a turn of phrase, less appropriate in a scientific treatise than in a popular address. My aim, however, has been exposition rather than proof. I have, it is true, been concerned not so much with results as with methods—methods of inquiry and methods of treatment; for the subject is too new and experience too recent to admit of many final generalizations. Nevertheless, the purpose of the book is primarily a practical one: to enable the busy reader—whether teacher or probation officer or whatever the motive for his interest may be—to gain some notion how the criminal in the making may best be studied and handled. Needless technicality has, I hope, been avoided. The scientist, should he examine the views here put forward, will find evidence, references, and technical data appended with some fullness in the footnotes.

The photographic illustrations, chosen from a small portrait gallery of snapshots, are inserted to give the visualizing reader some concrete picture of the cases that illustrate the text. They are, almost all of them, photographs of early acquaintances since grown up and reformed. The sanction of the young people depicted, whenever they have still been accessible, I have, of course, duly obtained; but the chance of their now being recognized from a childish likeness is small. With some exceptions, I have thought it better not to connect them with individual offenses: the reader, however, may find it a profitable

exercise to relate the anonymous portraits (if he can) with the particular case histories they may seem to fit.

To the editors of the *British Journal of Medical Psychology*, of the *Journal of Experimental Pedagogy*, and of *Psyche*, I must express my thanks for their consent, so willingly bestowed, to the reprinting of tables, case histories, and other matter already published in their pages. To the London County Council I am equally indebted for permission to reproduce statistics and to incorporate material from some of my official reports. As one of the Council's officers, I am required by its regulations to state that the Council is in no way responsible for opinions that stand under my name.

My obligations to individual persons are almost too numerous to specify. Without the help of Miss Gladys Bruce, my private assistant, and of the many other workers, both voluntary and official, who have furnished me with information on the cases here analyzed, the work could never have been undertaken. To Miss Margery Fry, J.P., one of the Metropolitan Police Magistrates, and to Miss Elizabeth Crosland and Miss Margery Moss, probation officers at Bow Street and Great Marlborough Street Police Courts, I am especially grateful for their kindness in reading the sections upon treatment. To my father, Dr. C. B. Burt, J.P., and to my sister, Dr. Marion Burt, I am indebted for similar help in the chapters on physical and pathological conditions. Dr. C. S. Myers, F.R.S., and Mr. T. W. Trought, J.P., have been good enough to read and criticize what I have said on the psychological clinic; my friend and colleague, Mr. J. C. Flügel, lecturer in psychology at University College, London, has done the same for the section on psychoanalysis, and Miss Evelyn Fox, honorary secretary of the Central Association for Mental Welfare, for the section on the treatment of defectives. To all of them I am deeply grateful for the help they have given and the suggestions they have made.

C. B.







# CONTENTS

PREFACE	PAGE
PREFACE . . . . .	v
CHAPTER	
I. INTRODUCTORY: PROBLEMS AND METHODS . . . . .	1
The Problem . . . . .	1
The Method of the Psychologist . . . . .	5
Study of the Offender's Present Situation . . . . .	5
1. His Offense . . . . .	5
2. His Personality . . . . .	6
3. His Environment . . . . .	7
Study of the Offender's Past History . . . . .	7
Study of the Offender's Future Progress . . . . .	9
The Material Analyzed in the Present Research . . . . .	11
Definition of Delinquent . . . . .	13
Definition of Juvenile . . . . .	15
Importance and Magnitude of the Problem . . . . .	18
Scheme of Inquiry . . . . .	21
II. HEREDITARY CONDITIONS . . . . .	28
The Inheritance of Crime . . . . .	28
The Legal Conception of Moral Imbecility . . . . .	29
The Philosophical Conception of a Moral Sense . . . . .	31
The Medical Conceptions of Moral Insanity and Moral Deficiency . . . . .	33
The Anthropological Conception of Moral Degeneracy . . . . .	36
The "Born Offender" . . . . .	38
Illustrative Cases . . . . .	39
Criminal Pedigrees . . . . .	43
The Relative Frequency of Hereditary Conditions . . . . .	47
Coefficients of Association . . . . .	52
Conclusion . . . . .	56
Treatment . . . . .	56
1. Eugenic Measures . . . . .	57
2. Segregation . . . . .	58
III. ENVIRONMENTAL CONDITIONS WITHIN THE HOME . . . . .	60
The Assessment of Environmental Factors . . . . .	60
1. Poverty . . . . .	64
Definition . . . . .	64
Local Distribution of Juvenile Delinquency . . . . .	67
Illustrative Cases . . . . .	76
Common Concomitants of Poverty . . . . .	84
Overcrowding . . . . .	84
Absence of Facilities for Recreation at Home . . . . .	86
Conclusions on the Influence of Poverty . . . . .	88
2. Defective Family Relationships . . . . .	90
3. Defective Discipline . . . . .	92

CHAPTER	PAGE
4. Vicious Home . . . . .	95
General Influence . . . . .	95
Parental Alcoholism . . . . .	96
Summary . . . . .	97
Treatment . . . . .	98
1. Removal from Home . . . . .	101
(a) Prison . . . . .	101
(b) Places of Detention . . . . .	102
(c) Industrial Schools . . . . .	105
(d) Reformatories . . . . .	107
(e) Boarding Out . . . . .	109
(f) Committal to the Care of Other Fit Persons . . . . .	111
(g) Voluntary Cases . . . . .	112
2. Improvement of the Material Conditions of the Home . . . . .	113
3. Fines and Recognizances Taken from the Parents . . . . .	115
4. Birching . . . . .	115
5. Improvement of Social Conditions in the Home . . . . .	119
IV. ENVIRONMENTAL CONDITIONS OUTSIDE THE HOME . . . . .	123
1. Companionships . . . . .	123
Companions of the Same Age . . . . .	123
Direct Influence . . . . .	123
Indirect Influence . . . . .	126
Adult Companions . . . . .	130
2. Conditions of Leisure . . . . .	134
Excessive Facilities for Amusement . . . . .	134
The Cinema . . . . .	137
Betting and Gambling . . . . .	144
Other Influences . . . . .	146
Defective Facilities for Amusement . . . . .	149
Places Where Offenses Are Committed . . . . .	151
Times When Offenses Are Committed . . . . .	151
Seasonal Variations in Juvenile Delinquency . . . . .	153
3. Conditions of Work . . . . .	169
Lack of Employment . . . . .	169
Uncongenial Employment . . . . .	171
Uncongenial School . . . . .	173
Summary . . . . .	178
Treatment . . . . .	180
1. Conviction Only as a Last Resort . . . . .	180
2. Dismissed . . . . .	181
3. Fines Taken from the Child . . . . .	182
4. Probation . . . . .	183
5. Change of Residence . . . . .	189
6. Juvenile Clubs . . . . .	190
7. Institutional Companionship . . . . .	191
8. Transference from an Uncongenial School . . . . .	192
9. Vocational Guidance . . . . .	193
10. Increased Facilities for Recreation Outside the Home . . . . .	194
11. The Official Regulation of Environmental Factors Affecting the Young and Adolescent . . . . .	197
V. PHYSICAL CONDITIONS: DEVELOPMENTAL . . . . .	199
The Physical and Medical Examination . . . . .	199
Deviations in Normal Physical Development . . . . .	200
1. The Undeveloped . . . . .	202

# CONTENTS

xi

CHAPTER

PAGE

2. The Overgrown . . . . .	206
Males . . . . .	206
Females . . . . .	208
3. Adolescence . . . . .	209
4. Periodicity in Girls . . . . .	215
5. Premature Puberty and Other Forms of Non-Correlation in Development . . . . .	218
Treatment . . . . .	220
1. Glandular Treatment . . . . .	221
2. Continuation of Training into the Adolescent Period . . . . .	222
3. Change of Environment . . . . .	223
4. Institutions for Older Delinquents . . . . .	223
(a) Borstal Institutions . . . . .	224
(b) Juvenile Colonies . . . . .	227
(c) Prison . . . . .	230
5. Fines and Supervision . . . . .	231
6. Female Adolescents . . . . .	232
(a) Physical Exercise . . . . .	233
(b) Supervised Social Recreation . . . . .	233
(c) Segregation . . . . .	233
(d) Marriage . . . . .	235
7. Religious Influences . . . . .	235
VI. PHYSICAL CONDITIONS: PATHOLOGICAL . . . . .	238
Frequency of Physical Defects . . . . .	238
I. General Conditions . . . . .	241
1. Transitory Weakness . . . . .	241
2. Chronic Disease . . . . .	242
II. Acute Illnesses . . . . .	247
1. Acute Illnesses Generally . . . . .	247
Treatment . . . . .	249
1. Adequate Medical Attention as a Preventive . . . . .	249
2. Physical Deficiencies to Be Treated First . . . . .	249
3. Special Medical Examination for All Delinquents . . . . .	250
4. Ascertainment of Medical History . . . . .	252
5. Importance of Minor Ailments . . . . .	253
6. Convalescence . . . . .	253
7. Removal to Country Homes . . . . .	253
8. Hygienic Measures at Home . . . . .	254
9. Industrial Schools . . . . .	254
10. Discipline . . . . .	254
11. Limitations of Purely Physical Treatment . . . . .	255
2. Illnesses Specifically Disposing to Nervous Instability . . . . .	256
(a) Epilepsy . . . . .	256
(b) Inflammation of the Brain or Its Membranes . . . . .	258
(c) Chorea . . . . .	260
Treatment . . . . .	261
1. Removal to Hospital or Other Institutions . . . . .	261
2. Attention to Mild and Early Stages . . . . .	263
3. General Hygienic Measures . . . . .	264
Conditions of Doubtful Significance . . . . .	264
(d) Head Injury . . . . .	264
(e) Syphilis . . . . .	266
III. Physical Irritations . . . . .	268
1. General . . . . .	268
2. Specific Irritations . . . . .	269
Treatment . . . . .	270

CHAPTER	PAGE
IV. Special Defects . . . . .	270
1. Vision . . . . .	270
2. Hearing . . . . .	273
3. Speech Defects . . . . .	274
Physical Peculiarities as Criminal Assets . . . . .	275
VII. INTELLECTUAL CONDITIONS: SUBNORMAL INTELLIGENCE . . . . .	279
Mental Testing . . . . .	279
The Intelligence of the Delinquent . . . . .	281
1. Mental Deficiency . . . . .	284
Frequency . . . . .	284
The Degree of Deficiency and Its Relation to Particular Offenses . . . . .	292
Various Types . . . . .	294
1. The Young and Passive . . . . .	294
2. The Older and More Active . . . . .	294
3. The Adolescent and Adult . . . . .	294
4. The Unstable . . . . .	295
5. Defectives with Specialized Talents . . . . .	295
The Negative Influence of Mental Defect . . . . .	296
Treatment . . . . .	298
1. Psychological Examination . . . . .	299
2. Systematic Ascertainment of Mentally Deficient Cases . . . . .	299
3. Special Day Schools for the Mentally Deficient . . . . .	301
4. Home Supervision . . . . .	301
5. Residential Institutions for Older Defectives . . . . .	303
6. Special Industrial Schools for Defective Children . . . . .	304
7. Hostels . . . . .	304
8. Guardianship . . . . .	305
9. Sterilization . . . . .	306
2. Dullness . . . . .	307
Types and Illustrative Cases . . . . .	309
1. The Aggressive . . . . .	310
2. The Apathetic . . . . .	312
Treatment . . . . .	316
1. Special Classes for Dull and Backward Children . . . . .	316
2. Segregation . . . . .	317
3. Guardianship . . . . .	318
4. Hostels . . . . .	319
5. Industrial Schools . . . . .	319
6. Choice of Employment and Suitable Vocational Training (Semi-Skilled Labor) . . . . .	320
3. Educational Backwardness . . . . .	321
Treatment . . . . .	328
1. Examination . . . . .	328
2. Special Intellectual Defects . . . . .	329
3. Special Emotional Disabilities . . . . .	330
4. Special Classes . . . . .	330
5. Change of Class or School . . . . .	331
6. Industrial Schools . . . . .	331
7. Choice of Employment and Suitable Vocational Training (Simple Trades) . . . . .	331
8. Inculcation of General Interests and Information . . . . .	333
VIII. INTELLECTUAL CONDITIONS: SUPERNORMAL AND SPECIAL ABILITIES . . . . .	335
Supernormal Ability . . . . .	335

# CONTENTS

xiii

CHAPTER

PAGE

Treatment . . . . .	341
1. Passive Expectancy . . . . .	341
2. Investigation of Causes . . . . .	342
3. Change of School or Class . . . . .	343
4. Change of Home Surroundings . . . . .	344
5. Choice and Change of Employment (Semi-Profes- sional Work, Technical or Clerical) . . . . .	345
6. Industrial Schools and Reformatories . . . . .	346
7. Rational Argument . . . . .	347
Special Abilities . . . . .	348
1. Special Motor Capacity . . . . .	348
2. Special Language Facility: The Verbalist . . . . .	349
3. Special Mental Imagery . . . . .	350
Daydreams and Fantasies . . . . .	355
Treatment . . . . .	359
Children's Lies . . . . .	361
Types of Lies . . . . .	361
Pathological Lying . . . . .	366
Treatment . . . . .	375
1. Differential Treatment . . . . .	375
2. Avoid Provocative Occasions . . . . .	376
3. Confession . . . . .	377
4. The Encouragement of Confidence . . . . .	378
5. Literary Instruction . . . . .	379
6. Scientific Instruction . . . . .	380
7. The Avoidance of Pious Figments . . . . .	381
<b>IX. TEMPERAMENTAL CONDITIONS: INSTINCTS AND EMOTIONS . . . . .</b>	<b>382</b>
The Emotional Aspect of Mind . . . . .	382
The Measurement of Temperamental Tendencies . . . . .	383
<i>Experimental Methods</i> . . . . .	383
1. Emotional Tests . . . . .	383
2. Moral Tests . . . . .	388
<i>Observational Methods</i> . . . . .	395
The Personal Interview . . . . .	396
Standard Situations and Standard Personalities . . . . .	399
Inborn or Inherited Tendencies . . . . .	400
Instinct and Emotion . . . . .	402
SPECIFIC INSTINCTS . . . . .	404
General Influence . . . . .	404
1. Hunger . . . . .	408
2. Sex . . . . .	409
3. Anger . . . . .	415
4. Acquisitiveness . . . . .	426
5. Hunting . . . . .	433
6. Wandering . . . . .	435
Amnesic Fugues . . . . .	439
7. Curiosity . . . . .	444
8. The Herd Instinct . . . . .	445
9. Self-Assertion . . . . .	449
Cruelty . . . . .	451
<b>X. TEMPERAMENTAL CONDITIONS: INSTINCTS AND EMOTIONS—</b>	
<i>Continued</i> . . . . .	454
Specific Instincts— <i>Continued</i> . . . . .	454
10. Self-Submission . . . . .	454
11. Fear . . . . .	456

CHAPTER	PAGE
12. Disgust . . . . .	458
13. Affection . . . . .	459
14. Grief . . . . .	461
15. Joy . . . . .	468
16. Play . . . . .	469
Conclusion . . . . .	470
Treatment . . . . .	471
1. The Fallacy of Hedonistic Penology . . . . .	471
2. Sublimation, Not Suppression, of Provocative In- stincts . . . . .	473
3. Treatment of the Acquisitive Impulse . . . . .	474
4. Treatment of Truancy and Running Away . . . . .	476
5. Treatment of Angry Impulses . . . . .	479
6. Treatment of the Juvenile Gang . . . . .	480
7. Treatment of Sex Impulses . . . . .	482
8. Encouragement of Inhibitive Instincts . . . . .	483
9. Need for Mental Occupation . . . . .	483
XI. GENERAL EMOTIONAL INSTABILITY: HABIT FORMATION . . . . .	484
General Emotional Instability . . . . .	484
General Emotionality . . . . .	484
The Unstable Child . . . . .	485
Definition of the Unstable and the Temperamentally De- fective . . . . .	490
Group Factors in the Emotions . . . . .	492
Treatment . . . . .	493
1. Permanent Segregation of the Temperamentally De- fective . . . . .	494
2. Temporary Removal of the Unstable . . . . .	495
3. Country Life . . . . .	496
4. Discipline . . . . .	497
Repressed Types . . . . .	497
Unrepressed Types . . . . .	497
5. Physical Exercise and Recreation . . . . .	500
6. The Formation of Wholesome Habits . . . . .	501
The Unemotional . . . . .	502
Treatment . . . . .	502
Habit Formation . . . . .	503
General Principles . . . . .	503
1. Fixation . . . . .	504
2. Modification . . . . .	505
(a) Modification of Reactions . . . . .	506
(b) Modification of Stimuli . . . . .	507
Treatment . . . . .	510
1. Removal of Opportunities . . . . .	510
2. Rewards . . . . .	511
3. Penalties . . . . .	512
4. Graded Moral Exercises . . . . .	512
5. Removal from Old Surroundings . . . . .	514
XII. SENTIMENTS AND COMPLEXES . . . . .	515
Acquired Emotional Dispositions . . . . .	515
Sentiments . . . . .	518
1. Sentiments of Attraction . . . . .	518
Absence of Desirable Interests . . . . .	518
Presence of Undesirable Interests . . . . .	519
2. Sentiments of Antagonism . . . . .	522



# CONTENTS

CHAPTER	PAGE
3. Mixed or Ambivalent Sentiments . . . . .	523
Complexes . . . . .	524
1. Stepmother Complex . . . . .	524
2. Authority and Disgust Complexes . . . . .	527
Moral Conflicts . . . . .	529
3. Sex Complexes . . . . .	534
4. Complexes of Inferiority and Self-Assertion . . . . .	536
Frequency of Particular Complexes . . . . .	539
Treatment . . . . .	545
1. The Detection of Conflicts and Complexes . . . . .	545
2. Psycho-Analysis . . . . .	546
3. Reéducation . . . . .	550
4. The Child's Consciousness of Himself . . . . .	552
5. The Need for a Sympathetic Confidant . . . . .	553
6. The Cultivation of Abstract Sentiments . . . . .	554
XIII. NEUROSES . . . . .	555
Nature and Frequency . . . . .	555
Neurasthenia and Anxiety States . . . . .	557
Obsessive Thoughts . . . . .	558
Compulsive Actions . . . . .	560
Hysteria . . . . .	562
Psychopathic Cases . . . . .	569
Treatment . . . . .	571
1. A Special Institution . . . . .	571
2. Psycho-Therapy . . . . .	572
XIV. CONCLUSION . . . . .	574
Causation . . . . .	574
Multiplicity of Contributory Factors . . . . .	574
Variety of Major Factors . . . . .	575
The Relative Importance of Congenital and Non-Congenital Factors . . . . .	577
Efficacy of Treatment . . . . .	583
APPENDICES	
I. Samples of Handwriting, Composition, and Physiognomy . . . . .	589
II. The Psychological Clinic for Juvenile Delinquents . . . . .	592
III. Selected References . . . . .	604
INDEX OF AUTHORS . . . . .	609
INDEX OF SUBJECTS . . . . .	613



## DIAGRAMS AND ILLUSTRATIONS

	PAGE
1. "B. I," AGED 15 $\frac{7}{12}$ . . . . .	<i>Frontispiece</i>
2. PEDIGREES OF JUVENILE DELINQUENTS, CASE 1	<i>facing</i> 46
3. PEDIGREES OF JUVENILE DELINQUENTS, CASE 2	<i>facing</i> 46
4. LOCAL INCIDENCE OF JUVENILE DELINQUENCY IN LONDON	70
5. TOMMY B., AGED 10 $\frac{19}{12}$ . . . . .	<i>facing</i> 76
6. MONTHLY FLUCTUATIONS IN JUVENILE AND ADULT CRIME, COMPARED WITH VARIATIONS IN WEATHER	155
7. MONTHLY FLUCTUATIONS IN JUVENILE OFFENSES OF VARIOUS TYPES . . . . .	163
8. MONTHLY FLUCTUATIONS IN ADULT OFFENSES OF VARIOUS TYPES . . . . .	164
9. MAGGIE H., AGED 18 $\frac{11}{12}$ . . . . .	<i>facing</i> 206
10. AN OVERGROWN GIRL, AGED 17 $\frac{3}{12}$ . . . . .	<i>facing</i> 207
11. AGE AT FIRST CONVICTION . . . . .	211
12. SYSONBY VILLAGE COLONY FOR ADOLESCENT DELIN- QUENTS . . . . .	<i>facing</i> 228
13. SYSONBY; LONDON BOYS AT THE COLONY . . . . .	<i>facing</i> 229
14. DISTRIBUTION OF JUVENILE DELINQUENTS ACCORDING TO INTELLIGENCE . . . . .	283
15. DISTRIBUTION OF JUVENILE DELINQUENTS ACCORDING TO EDUCATIONAL ATTAINMENTS . . . . .	283
16. FACSIMILE OF LETTER BY "JIM" . . . . .	<i>facing</i> 316
17. FACSIMILE OF LETTER BY "MAY NAYLOR" . . . . .	<i>facing</i> 370
18. FACSIMILE OF LETTER BY "MAY LOMAX" . . . . .	<i>facing</i> 371
19. "B. II," AGED 14 $\frac{3}{12}$ . . . . .	<i>facing</i> 590
20. "G. I," AGED 16 $\frac{3}{12}$ , AND "G. II," AGED 15 $\frac{7}{12}$ . . . . .	<i>facing</i> 591
21. SPECIMEN OF HANDWRITING OF "B. II" . . . . .	<i>facing</i> 592
22. SPECIMEN OF HANDWRITING OF "B I" . . . . .	<i>facing</i> 592
23. SPECIMEN OF HANDWRITING OF "G. I" . . . . .	<i>facing</i> 593
24. SPECIMEN OF HANDWRITING OF "G. II" . . . . .	<i>facing</i> 593

# DIAGRAMS AND ILLUSTRATIONS

1	The Law of the Sea
2	The Law of the Sea
3	The Law of the Sea
4	The Law of the Sea
5	The Law of the Sea
6	The Law of the Sea
7	The Law of the Sea
8	The Law of the Sea
9	The Law of the Sea
10	The Law of the Sea
11	The Law of the Sea
12	The Law of the Sea
13	The Law of the Sea
14	The Law of the Sea
15	The Law of the Sea
16	The Law of the Sea
17	The Law of the Sea
18	The Law of the Sea
19	The Law of the Sea
20	The Law of the Sea
21	The Law of the Sea
22	The Law of the Sea
23	The Law of the Sea
24	The Law of the Sea
25	The Law of the Sea
26	The Law of the Sea
27	The Law of the Sea
28	The Law of the Sea
29	The Law of the Sea
30	The Law of the Sea
31	The Law of the Sea
32	The Law of the Sea
33	The Law of the Sea
34	The Law of the Sea
35	The Law of the Sea
36	The Law of the Sea
37	The Law of the Sea
38	The Law of the Sea
39	The Law of the Sea
40	The Law of the Sea
41	The Law of the Sea
42	The Law of the Sea
43	The Law of the Sea
44	The Law of the Sea
45	The Law of the Sea
46	The Law of the Sea
47	The Law of the Sea
48	The Law of the Sea
49	The Law of the Sea
50	The Law of the Sea

# THE YOUNG DELINQUENT

## CHAPTER I

### INTRODUCTORY: PROBLEMS AND METHODS

*Judicis officium est, ut rem, ita reum cognoscere.*

It is the business of the judge to consider, not only the offense, but also the offender.

FRANCIS BACON.<sup>1</sup>

### The Problem

One sultry August afternoon in a small and stuffy basement kitchen not far from King's Cross Station, I was introduced to a sobbing little urchin with the quaint alliterative name of Jeremiah Jones.<sup>2</sup> Jerry was a thief, a truant, and a murderer. When first I saw him, he was just seven and a half years old, a scared and tattered bundle of grubbiness and grief, with his name still on the roll of a school for infants. Yet, at this tender age, besides a long list of lesser faults, he had already taken another boy's life.

Murder is a most rare offense for a child of school age. Indeed, among all the young criminals my work has brought to me, Jerry is the only one who has gone beyond mere threats and wild attacks, and has actually carried out an expressed resolve to kill. Nevertheless, his case, as it unfolds itself, is in many ways typical. And a sketch of his short history will

---

<sup>1</sup> *Essays or Counsels, Civil and Moral*, lvi, "Of Judicature."

<sup>2</sup> For manifest reasons it has usually seemed wiser, wherever an actual case is described in detail, to insert fictitious names of persons. In making substitutions of this sort, I have endeavored always to preserve the special associations of the original, keeping, for example, as here, to a name that is indicative of the same race or nationality. Where the change does not interfere with the relevant background or history, I have sometimes used a like liberty with places and dates.

serve better than any other instance to show what concrete problems and what abstract issues confront the practical psychologist in his study of juvenile crime.

Jerry was an only child, the illegitimate offspring of a chance encounter. The boy's mother had been a chambermaid in a small London hotel; and the father, described as "a quiet gentleman," well connected and seemingly well-to-do, had been a passing visitor to town; his name and occupation remain untraced. The woman, of Welsh extraction, was in temperament somewhat dull and erratic. She had lately obtained work as a packer in a warehouse; from her wages, twenty-six shillings weekly, she paid out seven shillings as rent for the clean but subterranean tenement, half scullery, half bedroom, which formed the home of Jerry, herself, and her own elderly mother, the devoted grandmother of the boy.

At the age of six, while trying to clamber on a moving lorry, Jerry had fractured his skull, and had been sent first to a hospital, and then to a home for convalescents. His school was some twenty minutes' walk from his house; and Jerry, returning from his ten weeks' holiday, found it agreeable to linger round the subway station and the railway terminus (both alluringly close to the school gates), instead of submitting to the discipline of a well-ordered classroom, lettering, figuring, and sitting still upon a bench. If he missed his food, he could stay the pangs of hunger by snatching buns from the restaurant counter, or tugging bananas out of crates on the platform; once or twice he stole pennies from his grandmother's purse. To correct his truancy he was sent to another and a nearer school; and later, as the habit persisted, his mother was first cautioned, and then summoned and fined. Thereupon she thought it cheaper to bargain with a neighbor to look after the young defaulter for six shillings a week, while she and the grandmother were away at their work. And so, for a month or two, his wandering ceased.

At length, on a midsummer morning, he and two other little truants strolled off to catch minnows in the Regent's Canal, a favorite fishing ground for young fugitives from school. The smallest of the trio had a twopenny toy, one that



London children call an "aeroplane" (it consists of a propeller of bent tin, revolving on a screw of twisted wire; you flick the propeller, and it spins off, sailing round and back to your feet again, like a boomerang). Jerry demanded the plaything. The appeal was many times repeated and refused. Jerry, still cool and self-contained, announced that, unless he "had that airyplane," he would "drahnd" the owner. The owner merely scoffed and pulled a face. So Jerry carried out his threat. With a little skillful footwork, he threw the other off his balance; tipped him backwards into the water, well knowing (so he said) that "the water would choke him"; kicked away the child's fingers, as he clutched the bank; and then watched him, with jibes and taunts, while his body went under.

At the inquest, the boy's death was held to be an accident. Jerry declared that his companion, while pitching a stone into the canal, had tumbled in backwards, not a very credible feat. It was only in the course of a later inquiry, arising out of Jerry's fresh mental symptoms, that the truth incidentally emerged. From fear or from a guilty conscience, the boy's behavior after the tragedy had grown increasingly eccentric; there were wild outbursts of inexplicable passion, half terror and half temper, such as, in an adult, would have been called hysteria or mild mania. A psychological examination was accordingly requested; and, during the progress of it, I got, without much difficulty, an avowal of the crime. The confession revealed, what he had formerly denied, the presence of a small witness; and, on being interviewed, this third member of the truant party confirmed the chief particulars. Jerry, he said, had stored up some spite against the other boy; and, more than once, had threatened to "take him to the cut and shove him in."

During all these weeks, no doubt from the same little lips, the true account of the victim's death had gone circulating from mouth to mouth; and reached at last the bereaved family. The father, in no uncertain terms, came breathing wild justice and revenge. It was said that he dragged Jerry's mother from her door and down the steps by her hair. And presently I

received a pathetic letter from the distracted woman, begging for her boy to be sent away. In an ill-formed hand, with many flourishes and underlinings, she wrote: "The People are tormenting both *Myself* and *child down*<sup>3</sup> so much and give no *Peace*. P.S.—They are stopping Boy from going to school *Now*." Jerry accordingly was removed from London and conveyed to another home.

Here, then, is the story of one little criminal's brief and early career. The problem now arises: what is to be done with such a child? Is he to be birched, reprimanded, placed under permanent restraint, or sent back to his parent's care? Can we operate upon his brain, or dose him with some potent drug? Shall we simply mete out to him and to his like, according to some just but mechanical tariff, a penalty proportioned to the measure of each offense—a beating for a lie, a fine for a robbery, a month's confinement for each day's truancy, and lifelong imprisonment or the forfeit of a life for another life taken? Or is there any method yet more elastic, either of treatment or of training, speedy or slow, that may convert him from a young but already hardened sinner into a sane, self-respecting, law-abiding citizen? Or, finally, can nothing redeem him from the downward path he has so early taken, so that, indeed, as some have actually contended, it would be best, were it only permissible, to end him at once in a lethal chamber?

The whole question is one, not so much for a legal or a moral code, but, in the last resort, for scientific investigation. A crime is not a detached or separable fact, self-contained and self-subsisting. It is only a symptom. It is a mental symptom with a mental origin. And there is now a definite body of ascertained knowledge, tracing mental symptoms to their causes, just as medical knowledge tracks down the sources of bodily disorders, and so can prescribe for each its proper treatment or appropriate cure. The study of the criminal thus becomes a distinct department of this new science—a branch of individual psychology; and the handling of the juvenile offender is, or should be, a practical application of known psychological

---

<sup>3</sup> Sc. "down here."

principles. To whip a boy, to fine him, to shut him up in a penal institution, because he has infringed the law, is like sending a patient, on the first appearance of fever, out under the open sky to cool his skin and save others from the infection. It is as blind and unintelligent as the primitive treatment of malaria, in the days when the parasite was unlooked for and the mosquito ignored. With moral disorders as with physical, we must find and fight not symptoms but causes. Not before causes have been discovered can cures be advised.

### The Method of the Psychologist

The psychologist, therefore, in approaching the young delinquent takes a path very different from that of the policeman or detective. It is not on the investigation of the offense, but on the investigation of the offender, that his efforts are primarily focused. To discover the culprit, to prove the charge, to bring the transgression under its proper legal category, these are but the first and the easiest steps in the treatment of a criminal of seven. With the misdeeds of immature boys and girls, the main issue to be answered is not—by whom was this crime committed? but, why did this particular child commit any crime at all? And throughout it becomes the concern of the psychological adviser, in every case and on every occasion, to study, first and foremost, the delinquent as an individual.

What, then, is the special method which the scientific investigator adopts in searching for the causes of any particular misdeed? It is nothing less than the taking of a complete case history. He institutes an intensive inquiry into the whole psychological situation, with a survey, as detailed and as comprehensive as he can make it, of the past, the present, and the future.

#### Study of the Offender's Present Situation

1. His Offense.—In most cases, the convenient starting point will be the nature and apparent motive of the last offense. It is, however, upon the inward character of the act, not upon its outward, formal classification, that the psychologist chiefly concentrates. He inquires, of course, what precisely it is that the

parent or officer complains of; but he seeks to view the child's transgression from the standpoint of the child himself. As a preliminary, he may reconstruct, with all the minuteness possible, the actual conditions of the incident, what the child was probably feeling, thinking of, or wishing for, at the moment of the deed.<sup>4</sup> The testimony of Jerry's companion shows how an apparent accident may turn out to have been a real and sinister crime; more commonly, perhaps, what at first was taken for a crime proves, wholly or in part, to be the mere result of chance, ignorance, or misfortune; and often what looks a motiveless outrage resolves itself upon analysis into a perfectly intelligible reaction to an unsuspected situation.

2. His Personality.—Having gained a provisional picture of the true nature of the offense, the psychologist begins with a routine examination of the child himself. He notes the health, the strength, the general condition of the young delinquent's body; and then tests and reviews in turn the various capacities of his mind—his level of intelligence, his traits of character, his daily habits, interests, and emotions—all the while con-

---

<sup>4</sup> I do not, of course, mean that the first question put to the child should be, "What made you commit this offense?" I am speaking rather of the first question the psychologist puts to himself.

Into the technique of interrogating young delinquents, I have no space to enter at length. The order of the headings, as given in the text, is by no means the invariable order of advance. Personally, I prefer a circuitous enveloping approach, a series of outflanking movements, with resources first accumulated and then kept ambushed in reserve, rather than a blunt frontal attack. Official reports from the school and the home visitor should be procured, if possible, beforehand. Then the parent is interviewed, but never, of course, in the presence of the child. With the child himself I usually commence, not with any stern or direct cross-examination, but with simple tests of mental ability—tests, to begin with, of a fairly mechanical kind, such as reading, spelling, or arithmetic, passing to harder tests, as the child's initial apprehensions are calmed and overcome, and working through most of the intellectual tests before the child's fears or tears are reëxcited by any allusion to the actual trouble. The analysis of character and conduct is rendered infinitely easier when a knowledge of the child's intelligence and general caliber has thus been gained at the outset. With older children a vocational inquiry, or sometimes an inquiry into health, is more likely to disarm suspicion and establish friendly relations. But in every case where the child's guilt is still problematic, the investigator should be equipped in advance with all the available facts.

sidering whether some specific defect, physical or psychical, of temperament, intellect, or will, may have contributed to the final outbreak. Here, in this early part of the main investigation, the analysis is greatly aided by the use of psychological tests. The new device of mental testing, and particularly the measurement of intelligence, have entirely revolutionized the old methods of studying the criminal; incidentally, too, they have swept away much of the value of earlier observations and conclusions, based as these were on mere personal impression and vague inference.

3. His Environment.—Having learnt all he can of the child's general nature, the psychologist proceeds next to influences that surround him. With a clear knowledge of the offense and the offender, he now knows what are the crucial points to determine. In most instances, he must survey the child's whole social setting, both moral and material—the home in which he is living, the companions with whom he plays, the opportunities and temptations that beset him, the efficiency of the restraint that should hold him back, the success or failure of the superintendence that his parents are able to bestow. Jerry, for example, was by nature a weak, backward, and excitable boy—just the type of youngster likely to dive into the first mischief that offered. But the special forms his mischief took cannot be rightly understood until we have noted the conditions in which he was placed—the distance of his school, the proximity of the canal, the daily absence of his mother, the fond but foolish laxity of his grandmother's control. In this case as in every other, the social data are as important as the personal; and the two together yield a synoptic view of the situation at the moment, with all its inner and outer components.

#### Study of the Offender's Past History

But to take, as it were, a cross section of the child's position at a given minute of his life, though suggestive and essential, is still far from enough. One cut across the trunk tells little of the weight or rottenness of the timber as a whole. No human action is a sudden, isolated birth of will, the mushroom upstart of an hour. It has its gradual genesis—a seed, a root,



a growth, a fructification. The delinquent's character and conduct, what he now is and what he has just done, these are the fruit of a long and complicated process of development; and his present predicament, with all its problems and temptations, must be viewed, not as the mere sum of its contemporary constituents, but as the product of converging forces operating cumulatively throughout his life.

We come, therefore, to the second main stage in the inquiry, often the longest stage of all: our survey of the present must be supplemented by a history of the past. A preliminary outline may already have been constructed. From the teachers' reports, from the Court and care committee records, from the points noted at successive medical inspections, the salient facts may already have been gleaned. The gaps can be filled in from the replies of the parents. And having thus obtained a thorough insight into the general background of the case, the psychologist at last comes back to the offender and his offense. Then, and not till then, will he seek to elicit the boy's own story.

Jerry's previous history throws much light upon his culminating exploit. The main events we have already observed. We have seen how the long holiday that followed his accident implanted a deep distaste for school and so led him to play the incorrigible truant. Further exploration throws up another factor. It shows how Jerry, dimly conscious of a shadow on his birth, slowly framing to himself a notion of some social grievance, had grown fiercely resentful of the slurs that the neighbors cast upon his parentage. The very playfellow whose life he took was wont to taunt him with an ugly name; more than once Jerry had felt a wish to silence this aspersion, a dishonor which, though he could not fully comprehend it, seemed to make both himself and his family outcasts from the rest. This long-standing provocation, more than any passing whim for a twopenny toy, was the ulterior motive, though doubtless a half-unconscious motive, for his sudden violence. To understand why a passing reminder of his shame should, in a flash, fire off a tendency to kill, we should need to probe more deeply into the hidden instinctive bases of human nature and behavior.

We have, then, in each investigation, to dig back and uncover



the underground foundations. We must explore all the antecedent influences that have been making, molding, perhaps marring the young offender, day by day and year after year, from the first instant when he was still a single cell within his mother's womb. And here, in this second portion of the whole inquiry, another new device of technical procedure brings aid to the psychologist. What the method of mental testing does for the study of intellectual capacity, that the method of so-called psycho-analysis performs for the study of the growing character. By this and other expedients, by a scrutiny of all available records and reports, by renewed interviews with the child and his parents and his teachers, the investigator should at last be able to retrace, in fullest detail, the whole biography of the offending individual, and so gradually to discover what forces in the past have brought the child to where he now stands.

#### *Study of the Offender's Future Progress*

Thirdly, the psychological adviser must look forward to the future. To predict what will make a bad boy good is of even greater consequence than to learn what has made a good boy bad. To discover the possible means of ultimate reform is as urgent and essential as to ascertain the probable causes of previous misdemeanors. No psychologist, therefore (unless, as too often happens, he is compelled), should decide a case after a single hearing. A few provisional recommendations he may put forward—a word to the mother upon discipline, a note to the school upon health and intelligence, a suggestion to the care committee for a regular visitation to the home, and perhaps a grave talk with the child himself; but these are to be regarded, not as final remedies, far less as expiations that wipe the slate clean, but rather as the beginning of a fresh and specific experiment in individual psychology.

A man is not a planet; his further movements cannot be deduced merely from a record of past tendencies and present situation, however exhaustive that record may be. He must be tried and treated first by one method and then by another. The psychologist, with the aid of his colleagues, watches the

working of some provisional plan; modifies it tentatively from time to time; and corrects his expectations by the verified results. Indeed, it is this further following-up, with the child all the while under expert eyes, that often proves the most instructive source of information.

Jerry has been sent to three successive homes of three very different kinds; in each the experiences he has been through, and the ways he has met them, have been helpful both in forming his character and in shedding new light upon his inner mental needs. Reports upon his continued progress are sent in month by month; and, after two years' study of his slow development, there evidently remains a great deal more that has yet to be learnt about his capabilities for good and evil. To predict, with any degree of assurance, how soon he may be trusted to go back to his own mother and conduct himself like a normal schoolboy, would still be premature. Time alone can bring the ultimate solution.

In its broadest outlines, then, every psychological examination should pursue these three directions—conspective, retrospective, and prospective in turn. It should comprise, first, a systematic survey of the whole situation as it is at present; secondly, a genetic study of the history of the offender throughout his past; and, thirdly, a trial scheme of recommendations regarding treatment for the future, all checked and supplemented, as time goes on, by an after-study of the effects secured. In every case, no matter what the crime or who the delinquent, the psychologist begins anew with each child as he finds him, coming to him individually, and regarding him throughout as a unique human being, with a special constitution, a special life story, a special place and problem of his own.

This seems, at first sight, an overwhelming program. It is as though each little criminal were to be made the central subject of a protracted and methodical research. That, in a measure, is unquestionably true. Yet the undertaking is less formidable than it sounds. There are certain facts, certain wide generalizations of modern psychology, which greatly simplify the vastness of the problem. The investigator, after studying a long succession of cases, finds himself beginning to

recognize a series of recurrent types. In different individuals, and in varying combinations, the same causes, the same motives, the same accessory factors, come before his notice again and again. It is not, indeed, that a given offense has always an identical origin, as, in medical diagnosis, a given group of symptoms is often assignable to some specific germ. Rather, certain outer situations, reacting internally upon certain mental tendencies, seem peculiarly liable to provoke a criminal outburst—whether of theft, truancy, or personal assault—much as the mingling of two composite chemical substances may result in an explosion. By mere superficial observation—from the loudness of the noise, or the color of the flame—it may not be possible to deduce precisely what perilous reagents have been present; yet the probable conjunctions are limited in number, and the expert quickly learns for what ingredients he must look.

### The Material Analyzed in the Present Research

What, we must therefore ask, are the commonest causes that tend to issue in crime? How can their nature and likelihood be learned? Plainly, by analyzing a representative collection of cases according to a sufficiently comprehensive plan, and calculating the relative frequency of every factor so disclosed. If at the same time the individual children are made the subject of keen and continued scrutiny, it will be possible in the end to examine, not only the prevalence, but also the general mode of operation, of each contributory condition, and so to decide, not merely how powerful it is, but also in what manner it works.

It is chiefly from actual inquiries of this nature that the material for the following chapters has been drawn. I have taken two hundred consecutive cases of juvenile delinquency—all, in fact, for which I could get complete information for the particular conditions reviewed<sup>5</sup>—and have made a personal

---

<sup>5</sup> The actual number tabulated is 197—123 boys and 74 girls. Three cases were dropped, owing to the incompleteness of the data. This small group, of course, in no way represents the total number of cases examined by me in the course of my ordinary work; it merely forms a small and typical series analyzed intensively for the purpose of this research. For fuller particulars as to the origin and scope of the inquiry,

study of each one. But an examination of delinquents alone can never be conclusive. To find, among a batch of young offenders, that 8 per cent are, like Jerry, illegitimate, that 19 per cent come, like him, from very poor homes, and that nearly 30 per cent are, as he is, definitely dull and backward—all this means nothing, until we have discovered how often the normal, unoffending child is similarly afflicted. A control group is essential. To this end, therefore, I have carried out a parallel research among the ordinary school population, and have endeavored to make identical studies of four hundred non-delinquent children of the same age, of the same social class, living usually in the same street and attending the same school. Both delinquents and non-delinquents have been tested, medically inspected, and reported upon periodically by teachers and visitors, according to the same prearranged scheme.

All the causes observed have been counted and classified. They fall into half a dozen main divisions. The frequency of a given factor among the delinquents, as compared with its frequency among the remainder, may be taken as indicating its relative importance, and the likelihood of its operation in any future set of cases.

But before proceeding to the actual results, it is desirable, first of all, to define with greater precision the kind of cases analyzed and the mode of analysis employed. What is meant by juvenile delinquency? Whom does the psychologist regard as delinquent, and whom does he consider juvenile? The answers to these questions may be given most simply by enumerating the offenses, and stating the ages, of the children examined in my research.

---

which has now extended over more than ten years, I may refer the reader to a report, already published, on "The Casual Factors of Juvenile Crime" (*Brit. Journ. Med. Psych.*, III, 1923, i, pp. 1-33). I should add that, since this preliminary report was published, the whole material has been worked over afresh, and a few substitutions made where more trustworthy case histories came later to hand in place of others that had proved less accurate. Here I should like to renew my expressions of gratitude to the numerous body of helpers named in my earlier articles—teachers, physicians, care committee workers, superintendents of homes for defectives and for delinquents—who have so generously continued to aid me in the further collection of facts.

### *Definition of Delinquent*

The offenses committed comprise, for the most part, such breaches of the law as would be punishable in an adult by penal servitude or imprisonment—stealing, burglary, damage, common assault, indecent assault, and soliciting; to this list must also be added certain other misdeeds which none but a child can commit, as truancy and being beyond parental control; and one or two, which, while offending against no explicit legal enactment, may become the ground for official intervention, for example, inordinate lying and sexual impropriety. A rough psychological classification of the offenses, together with the frequency of each, is given in Table I. It will be seen that larceny, and offenses akin to larceny, are by far the most prevalent, accounting, indeed, among male offenders for nearly 80 per cent of the total.<sup>6</sup>

There is, however, no sharp line of cleavage by which the delinquent may be marked off from the non-delinquent. Between them no deep gulf exists to separate the sinner from the saint, the white sheep from the black. It is all a problem of degree, of a brighter or a darker gray. This graded con-

---

<sup>6</sup> A useful classification of offenses, defined from a psychological standpoint with illustrative examples, and graded according to the social seriousness of the acts, will be found in a pamphlet by W. W. Clark (*Whittier Grading Scale for Juvenile Offenses*, California Bureau of Juvenile Research, 1922). Juvenile offenses are there divided into fourteen groups. About half a dozen concrete specimens are given for each offense, and their quality is marked upon a scale from 1 to 10. The marks allotted have been averaged from the ratings of a hundred experienced evaluators. With this schedule before him, the student can give a rough grade or mark for any criminal action; and it is suggested that a "delinquency index" may be computed for any particular offender by adding up the marks awarded according to the scale—that is, in effect, by taking the total number of offenses that he has committed, after weighting each according to its imputed gravity. The fundamental postulate involved in such a scheme is clearly open to objection. Are five acts of simple truancy (graded 1) equivalent to one serious theft (graded 5)? Are two serious thefts equal to one murder (graded 10)? The ordinary apportionment of fines, damages, or financial compensation certainly implies some such scale of ratios; but the plain man may justly question the applicability of an arithmetic so simple. Nevertheless, the method is suggestive for the purpose of broad quantitative comparisons, e.g., for correlating the gravity of the offender's actions with



TABLE I.—CLASSIFIED LIST OF JUVENILE OFFENSES <sup>7</sup>*Showing Number in Each Category per 100 Delinquents of Either Sex*

I. SEX	Boys	Girls
A. Offenses with Opposite Sex:		
1. Of similar age and willing (including soliciting)	11.4	36.5
2. Of younger age or unwilling (assault)	2.4	0.0
B. Perversions:		
1. Offenses with same sex	3.3	1.4
2. Masturbation (excessive)	4.1	2.7
3. Indecent exposure	0.8	1.4
C. Obscenity (excessive, including "corrupting others" by talk)	2.4	7.6
II. ANGER		
A. Bodily Violence to Persons:		
1. Murder	0.8	0.0
2. Wounding	6.5	2.7
3. Violence without weapons; fighting, blows (excessive)	8.1	5.7
4. Cruelty to children or animals (with bodily injury)	4.1	0.0
B. Angry Reactions without Violence:		
1. Bad temper (excessive)	3.3	6.3
2. Incurability, being beyond control	5.5	12.2
3. False and dangerous accusations	0.0	4.1
4. Insult, and other forms of mental annoyance	0.8	1.4
5. Cruelty to children or animals (without bodily injury)	1.6	2.7
C. Violence to Property:		
1. Malicious damage or destruction	3.3	1.4
2. Mischievous damage or destruction	6.5	0.0
3. Damage by fire	0.8	0.0
III. ACQUISITIVENESS		
1. Stealing	78.9	43.3
2. Burglary	3.3	0.0
3. Begging	7.3	2.7
4. Swindling and Forging	2.4	0.0

the degree of his intelligence; and, in any case, the use of such a scale is bound to be more exact than a reliance on mere subjective impression or on a judgment purely personal.

<sup>7</sup>The six main headings here adopted, and the reasons for their adoption, will be explained in a later chapter (IX).

The subheadings include, not only the offenses for which the children were committed for examination or detention, but also recent or current offenses disclosed by later information. Often different offenses had been perpetrated by the same individual. Hence, the total of the figures against the several categories exceeds the total number of cases.



IV. WANDERING

	Boys	Girls
1. Truancy from school (persistent) . . . . .	17.1	4.1
2. Truancy from home (persistent) . . . . .	12.2	7.6
3. Sleeping away from home . . . . .	4.1	2.7
4. Running away (with intent to remain away) . . . . .	6.5	5.4

V. GRIEF

1. Attempted suicide . . . . .	0.0	1.4
2. Threatened suicide (persistent) . . . . .	0.0	2.7

VI. SECRETIVENESS

1. Lying (persistent or extravagant; and excluding the mere concealment of other delinquencies) . . . . .	4.9	13.6
---	-----	------

tinuity, the normal melting into the abnormal by almost imperceptible shades, is entirely in accord with what we now know of most other forms of mental deviation. The insane, the neurotic, the mentally deficient are, none of them, to be thought of as types apart, anomalous specimens separated from the ordinary man by a profound and definite gap; the extreme cases merge into the borderline, as the borderline merges into the average, with no sudden break or transition. It is the same with the moral faults of children; they run in an uninterrupted series, from the most heartless and persistent crimes that could possibly be pictured, up to the mere occasional naughtiness to which the most virtuous will at times give way. The line of demarcation is thus an arbitrary line, not a natural line; and delinquency is, at bottom, a social rather than a psychological concept. A child is to be regarded as technically a delinquent when his antisocial tendencies appear so grave that he becomes, or ought to become, the subject of official action.

*Definition of Juvenile*

As regards age, the limits accepted by the psychologist again diverge a little from those laid down by statute; once more they are wider, and less sharply drawn. In the eye of the law, a "child" is a person under 14; a "young person" is one between 14 and 16; a "juvenile adult," a person between 16 and 21; and the measure of responsibility differs from stage to stage.<sup>8</sup>

<sup>8</sup> We are dealing here, of course, with the definitions of British Law. The first two definitions are those of the Children Act, 1908 (Sec-

It is a maxim of criminal law that no person is to be considered guilty unless his act was the outcome of a guilty mind: *non est reus nisi mens sit rea*.<sup>9</sup> Legal guilt itself thus depends upon a psychological condition; and this in turn, it is held, depends partly upon age. With adults, the unlawful act in itself may be sufficient proof of a guilty state of mind—of criminal malice, negligence, or knowledge. But, where the offender “hath not yet attained *annum pubertatis*, viz., fourteen years,” the law presumes that he acted as he did without criminal intent<sup>10</sup>; and the burden of proving a guilty state of mind, either from the child’s previous declarations or from his subsequent concealment of his deed, is cast upon the prosecution. Conformably with this, the younger the child, the stronger must be the evidence of a guilty mind before he can be regarded as punishable by law: *malitia supplet aetatem*.<sup>11</sup> Where the offender is *infra aetatem infantiae*, that is, under the age of seven, it is a presumption *juris et de jure*, which no evidence

---

tion 131). The third somewhat self-contradictory category was implicitly introduced on the establishment of Borstal institutions by the Prevention of Crime Act, 1908 (Section 1, subsection (1) *a*). In the Juvenile Offenders Act of 1847—the first legislative recognition of the need for dealing differently with adult and with immature offenders—a child was defined as one under 12. This definition was preserved in the Summary Jurisdiction Act of 1879, the principles of which still largely govern the trial of children and young persons.

Throughout these various enactments the praiseworthy tendency has uniformly been to raise the upper limit. On psychological grounds, it might well be raised yet higher. The juvenile court might well seek jurisdiction over all adolescent cases, over every case, to put it at the lowest, where the offender’s age is below 18—that is to say, below what the old jurists conceived to be *etas plena pubertatis* (Hale, *loc. cit. inf.*, sec. 17); and, having established such jurisdiction in any given instance, it might well be permitted to retain it until the age of 21. Where property is concerned, the law is more cautious; and it is perhaps a significant anomaly that, to the legal view, a boy cannot take care of his property until he is 21, but can take care of himself from the age of 14.

<sup>9</sup> Justinian, *Institutes*, III, 107. “A person is not to be convicted as guilty unless it can be shown that he had a guilty mind” (Field, J., in *Chisholm v. Doulton*, *Queen’s Bench Reports*, XXII, 736, p. 739).

<sup>10</sup> Sir Matthew Hale [1609-76], *History of the Pleas of the Crown* (ed. Emlyn, 1800), Vol. I, Chap. iii, secs. 25-27. Cf. Blackstone, *Commentaries*, IV, 23, 24.

<sup>11</sup> Hale, *loc. cit.*, secs. 27, 28. Cf. Dyer, *Reports*, 104b.

whatever can rebut, that the child cannot appreciate the nature of his actions: he is *doli incapax*—wholly incapable of felonious intent.<sup>12</sup> Up to the age of 16, all children and young persons must be dealt with by a juvenile court<sup>13</sup>; after that age, offenders must be dealt with in the ordinary court as adults.

These clean-cut lines of chronological cleavage, however convenient for administrative needs, can hardly be accepted by the psychologist. For him, it is not a date in the calendar, but the actual degree of development, that makes one person a child, a second juvenile, and a third grown up. It is a matter of mental age rather than of natural age. A defective of 9 or 10 may have a mentality far below the normal child of 6 or 7; and to infer that the former must be responsible and the latter irresponsible, simply from a certificate of birth, would be flagrantly absurd. Towards the other end of the scale, apart from all question of defect, adolescence itself varies widely in its time of onset and completion; and, once again, to name a particular birthday as fixing the instant when every person ceases to be young and becomes an adult is to the psychologist as arbitrary as it is unjust.

In age, therefore, my own group of youthful cases extends well beyond the limits laid down by legal enactments. The entire series ranges from 18.0 years, the moment at which industrial school cases cease to be under the supervision of the managers, down to 7.0 for the girls and 5.0 for the boys. Just over half, however, fall within the years 12 to 15.

The actual offenders whose cases are here analyzed come from three main groups: first, children referred to me for psychological examination by magistrates, organizers of children's care, head teachers, parents, and secretaries of asso-

---

<sup>12</sup> Hale, *loc. cit.*, Cf. Marsh v. Loader, *Common Bench Reports* (New Series), XIV, 535.

<sup>13</sup> The establishment of special courts for juvenile cases, after several tentative experiments first in America and later in Great Britain, received legislative sanction from the Children Act of 1908, which amplified and amended the earlier statutes. The main provision (Section 111) is that a court of summary jurisdiction, when hearing charges against children or young persons, shall sit either in a special room or building, or at special times, so that adult and juvenile offenders are not tried at the same hour in the same place.

ciations dealing with the young; secondly, a somewhat smaller group encountered in an educational survey of a representative London borough; thirdly, a still smaller selection, examined from time to time during visits to remand homes or industrial schools, when recent entrants and representative samples have been specially tested and reviewed.

These, then, are the young people I propose to study as typical of juvenile delinquents.

### Importance and Magnitude of the Problem

To treat delinquency in the young as a separate topic, as a problem apart from criminality in adults, may seem, at first sight, a fault in procedure. There are, however, two strong reasons that unite to render this advisable. The juvenile offender is easier to study; and, at the same time, he is easier to reclaim.

That searching inquiries are less difficult while the offender is still a child, must be evident at once. The facts are then recent and accessible. Information about his birth, his family history, his early childhood, and his subsequent development, can as a rule be readily got from his parents. From his teachers a report is usually obtainable, to show what are his intellectual powers and moral tendencies, as observed for many years under known and regulated conditions. From care committee workers and attendance officers much can be learnt about his material and social surroundings. From the records of school medical inspections, precise data as to his bodily growth, his physical ailments, and his height and weight at various periods can always be procured. In childhood the mind is more easily analyzed. Character is less complex; motives simpler to unravel. Child psychology, as a science, is further advanced and more fully understood than the psychology of adults; with children, too, tests of intelligence and of school attainments can be quickly standardized, and readily applied. Nor is the young offender himself so resistive to examination. The old age-hardened criminal shirks the probe. To personal inquiries he submits with little willingness and much reserve; his thoughts, his wishes, and his inner life, are more obscure and subtle, con-

sciously disguised or unconsciously repressed. With youthful cases, on the other hand, we are, in every direction, nearer to verifiable beginnings; and the whole case history is shorter and less involved.

At the same time it is much easier, far more hopeful, and infinitely more urgent, to reform, or at least seek to reform, the transgressor while he is young. It is in childhood that most criminals commence their lawless careers. The majority of habitual offenders receive their first conviction before they are 21. During the susceptible years of infancy and youth the delinquent is still under guardianship; at home his actions are controlled and superintended by his parents, and at school by his teachers. His habits are not yet fixed irrevocably; his moral nature is still fluid, plastic, and unformed. Society, too, holds the adult as completely answerable for his misdoings, and exacts from him the fullest retribution; but the child it is disposed to look upon rather as a victim than as an aggressor, and to him it extends, with greater eagerness, its aid, its sympathy, and its indulgence.

The magnitude of the problem is beyond all question. Official statistics but partly reveal it. According to the latest figures available,<sup>14</sup> no less than 37,520 persons were charged before Juvenile Courts in England and Wales in 1913; of these almost exactly twenty thousand were under 14; and nearly two thousand were girls or young women. During the war, the number rose rapidly, until in 1917 it reached the high-water mark of 51,323; and has since declined to barely thirty thousand.<sup>15</sup> The

---

<sup>14</sup> *Home Office Report on the Work of the Children's Branch* (1923), p. 7.

<sup>15</sup> In London, during the year ended March 31, 1923 (the latest date for which figures are available), 1,158 children were the subject of proceedings under the Children or Education Acts; and 778 young persons were charged with punishable offenses. Of the former, barely 30 per cent were committed to industrial schools; and of the latter less than 15 per cent to reformatories. The four industrial schools maintained by the Council accommodate about 480 boys and 57 girls. The accommodation of the London elementary schools is approximately three-quarters of a million, the total scheduled school population being, for the year in question, 797,378. About 0.2 per cent of London school children, therefore, become the subject of judicial proceedings. For adults the official figures for convictions are roughly in keeping with this propor-



figures are large enough. But, as a London magistrate has ventured to observe, "with vigilance sufficiently increased, the number of charges could be doubled, trebled, or quadrupled."<sup>16</sup> In East London, which is popularly pictured as the most criminal quarter, about one child in three hundred is dealt with by the Juvenile Court within the space of a year; in New York nearly double that proportion are charged. Of my own cases the majority have never been charged at all, though many have been committing offenses almost weekly for several months and sometimes for several years.<sup>17</sup>

Ordinarily the two great woes of childhood are held to be

---

tion. During the year 1922-23 the ratio of receptions on conviction per 100 of the general population was 0.12. For the years 1904-14 it averaged almost exactly 0.5; and dropped below 0.1 towards the close of the war (*Reports of the Commissioners of Prisons, 1923, p. 5*).

<sup>16</sup> W. Clarke Hall, *The State and the Child* (1917), p. 11. Those to whom philanthropic agencies or better-class parents bring cases direct for advice, without the intervention of the police, are amazed to find what numbers of young people commit offenses, often serious and repeated, and yet, whether from accident or design, are never brought before a court.

<sup>17</sup> In an early survey having for its primary object an inquiry into the distribution of backwardness and mental deficiency in London schools, I kept at the same time a careful watch for cases of delinquency and of so-called moral defect. The proportion of delinquents thus discovered among the general school population was, for boys, 0.9 per cent, and, for girls, 0.6 per cent. But these figures comprise, for the most part, no more than the graver cases known to head teachers, and therefore, particularly among the boys, must form a gross underestimate. To the few thus ascertained must be added the many whose delinquencies are known to none but their parents and the still larger number whose misconduct is never detected until later in life, or being perhaps transitory, remains forever unknown except to themselves. For the type of offenses just enumerated and within the age limits just mentioned, the proportion of occasional delinquents among the total population for the same years cannot be less than 5 per cent for girls, nor less than 10 per cent for boys and youths. But by pressing the definitions for such offenses as the infringement of police regulations for such delinquencies as those connected with sex, and by including isolated petty thefts at home, one could expand the percentage to almost any degree. But be the actual figure what it may, the number of children prone to grave misconduct and needing special attention upon moral grounds would evidently, if the truth were better ascertained, be far greater than the number cared for on the ground of physical or mental defect, and probably quite as great as the number of necessitous children whose bodies are fed, and sometimes clothed, at the public expense.



disease and destitution. Delinquency is plainly a bigger peril than either; it shadows the life of the city child with far more persistence and frequency than either bodily illness or economic want. By scientific research, by organized social effort, by early detection and treatment, the burden of sickness and poverty has been progressively lightened. What has thus been done for obstacles to health and happiness must now be attempted for the wider and profounder evils that beset the growing soul.

### Scheme of Inquiry

Such, then, very briefly, are the scope, the nature, and the urgency of the problem. What, in broad outline, is to be the method of attack? The detailed scheme that I have used and developed, the minimum of points that needs careful ascertainment for each individual case, are set forth under systematic headings in the schedule that follows (pp. 22-24). The items italicized indicate the chief fields to be explored, and the most useful groupings into which the scattered facts can be brought together, and so reclassified for final interpretation and review. Such a scheme might, therefore, be adopted as the basis of case sheets or record forms.<sup>18</sup>

---

<sup>18</sup> For the preliminary reports required from the teacher, home visitor, medical examiner, and psychological assistant applying routine tests, separate forms will usually be needed, each confined to a particular aspect of the case. More detailed headings, suggestive for these purposes, will be found in the schedules appended to the following publications: Healy, *The Individual Delinquent* (1915), pp. 53-60; Breckinridge and Abbott, *The Delinquent Child and the Home* (1912), Appendix VI, pp. 333-43; J. Harold Williams, "Individual Case-History Outline," *Journal of Delinquency*, V (1920), pp. 71-83; and T. L. Kelley, "Mental Aspects of Delinquency" (*University of Texas Bulletin*, No. 1713, 1917), pp. 43-7. But, for intensive work, and for the final case description, printed forms and schedules are of little help except as a provisional guide. They are too inelastic. The order of logical review is not the order of ascertainment. The progress of each individual inquiry may show that in some directions the material stretches to an almost unlimited amount—to many foolscap pages and even to several notebooks; while in other directions and under other headings there may be, for a given case, little that is known and still less that is pertinent. Yet, mapping out as they do the ground to be covered, such tabulations are by no means worthless. The unsystematic and impressionistic commentaries—discursive letters rather than methodical reports—which are too often

## SCHEDULE I

## RECORD FORM FOR JUVENILE DELINQUENTS

*Name* (surname first in block letters, Christian names, and nickname or pet name commonly used).

*Age* .....  $\frac{\quad}{12}$       *Born* .....

*School* .....

*Address* .....

*Reference* (name of person or authority requesting examination).

*Informants* (names of acquaintance, visitor, probation officer, or benefactor supplying information and keeping in local contact with child: indicated in subsequent statements by appending their initials).

*Complaints or Offenses:*

*Home Circumstances:*

Father (alive? age, address if not living with family, occupation, wages).

Mother (alive? age, maiden name, address if not living with family, occupation—at home or away from home? wages).

Step-parents (if any).

Other children (Christian names, and ages; occupations and wages, if any).

Total income of family.

Rent of tenement. Number of rooms.

General characteristics of home (sanitary condition, cleanliness, tidiness, and culture; religion, discipline, marital conditions, type of street, etc.). Condition of child in regard to clothing, footwear, and cleanliness. General attitude of family towards child.

sent in by teachers, physicians, and care committee visitors, are apt to be as inadequate as they are superficial.

My own case summaries usually extend to two or three thousand words and to busy recipients must sometimes seem voluminous and cumbersome. It is my practice to dictate my findings in the form of consecutive memoranda, with paragraph headings inserted as I proceed. So far as possible, facts are kept separate from inference, and for all hearsay information, the source and its value are noted. A condensed copy, a page or so in length, is often made later on for the person or authority referring the child for examination.

For purposes of rapid reference I make a final abridgment on cards ruled into a dozen compartments. There are again no printed headings on the cards; the position of entry is a sufficient indication. The most important of the causative factors are marked by underlining. The ruling on the face of the card, together with the topics to be entered in each compartment, is illustrated below (p. 25). The back of the card

*Family History:*

Race, health, intelligence, temperament, morality, criminality, pauperism, constitutional or nervous ailments of an hereditary character, of (a) father's family, (b) mother's family, (c) child's brothers and sisters.

*Physical History:*

Conditions of pregnancy and birth.

Age of walking, talking, cleanliness, teething, menstruation or breaking of voice, and pubescence. Infectious, nervous, and other ailments; injuries (with special reference to severity and after-effects).

Reports of previous medical inspections.

*Present Physical Condition:*

Physiognomy and general appearance: stigmata.

Height.... Weight.... Vision.... Hearing....

Other anthropometric measurements (of chest, head, grip, etc.).

General health. Special ailments.

Athletic games, and records.

Habits in regard to sex, tobacco, diet, stimulants, or drugs.

Report of special medical examination.

*Intelligence*<sup>19</sup>:

Mental age or percentile grade, as ascertained by (a) Binet-Simon tests, (b) written "group" tests, (c) graded reasoning tests, or (d) "performance" tests; detailed marks for specific tests, with observations on method of attack and introspective comments of examinee.

*Special Abilities or Disabilities:*

Attention, observation, manual dexterity, linguistic ability, memory, imagery, association, etc., as the case may require; detailed marks for specific tests, with observations on method of attack and introspective comments of examinee.

*School Attainments:*

Standard reached.....(equal to work of this standard?).

Attendance. Age on leaving school (in years and months).

Mental age for reading, spelling, composition, arithmetic, writing, drawing, handwork, and other subjects.

Subjects preferred and disliked.

General knowledge.

Reports of head and class teacher.

is square ruled; and may be used for psychograms of special abilities or of instinctive tendencies. Such records can be filed alphabetically as a card index; and sorted and resorted, as a count up is required from time to time for particular conditions. A similar card, and the same scheme, may be used in jotting down rough notes during the interview itself, the back of the card being then used for lengthier histories, verbatim introspection, or specimens of the child's drawing and handwriting.

<sup>19</sup> For a list of serviceable tests, see Appendix II.

*Employment:*

Vocational tests (if applied) with results and recommendations.  
 First and subsequent situations (reasons for changes).  
 Nature of present employment (if any).  
 Number of hours worked per week..... Wages.....  
 Report of employer.

*Recreation and Leisure Hours:*

Companions. Chief habits, hobbies, and amusements. Continuation school, club, or other organization to which child is attached.  
 Reports of comrades or club authorities.

*Temperament and Character:*

General emotional stability. General type (repressed and sensitive or unrepressed and excitable).  
 Neurotic symptoms (walks or talks in sleep, dreams, nightmares, phobias, headaches, fantasies, daydreams, hysterical manifestations, etc.).  
 Development of instincts (appetite, sex, anger, acquisitiveness, wandering, fear, assertiveness, submissiveness, curiosity, disgust, sorrow, affection, cheerfulness, sociability).  
 Chief sentiments and interests (with special reference to child's attitude to other members of his home, present or past).  
 Chief complexes and mental conflicts, so far as analyzed.  
 Other personal or moral traits.

*Life History:*

With dates, changes of residence, of guardianship, of school, and of employment, influence of various guardians, teachers, and acquaintances; changes of character at puberty and otherwise: all with special reference to—

*History of Delinquencies:*

With dates, treatment (charged? if so, before what court, and with what decision?), and apparent results.

*Child's Own Story:*

With special reference to his motives—alleged, avowed, rationalized, or half unconscious; to his present situation as he views it; to his impressions of past practices, acquaintances, and influences; to his outlook and intentions for the future; appending also the results of later psycho-analyses: all, so far as possible, in the child's own words.

*Summary or Diagnosis:*

Mental abnormality (if any) formulated in terms of the usual classifications.  
 Probable lines of causation of misconduct.  
 Possible lines of constructive treatment.

*Recommendations:*

(With date of examination and signature of examiner.)

*Subsequent History:*

(With dates of subsequent notes.)

SCHEDULE II  
SAMPLE RECORD CARD

<i>Offenses or Complaints</i>	<i>School</i>	<i>Name and Age</i>
<i>Home Circumstances</i>	<i>Family History</i>	<i>Health and Medical History</i>
<i>Intelligence</i> (Results of Binet Tests)	<i>School Attainments</i> (Results of Educational Tests)	<i>Special Abilities or Disabilities</i>
<i>Temperament and Character</i>	<i>Recommendations</i>	<i>Results and After-history</i>

The chapters of this book will follow very much the same successive rubrics; and will deal, in order, with hereditary and environmental factors, and with the physical, intellectual, and emotional condition of the children themselves. I shall offer but few tables and figures; and shall use those few for corroboration more than for proof. In the past, too heavy a stress has been laid upon mere statistics; and little else has been discussed. My abstract descriptions I shall supplement, so far as space permits, by concrete case studies, choosing, wherever possible, those which have exhibited, in simple, vivid, and sometimes dramatic form, the one particular factor to be exemplified. More often than not, these illustrative cases are drawn, not from the representative sample of two hundred, but from the many that are inevitably sent to a psychologist, often solely on account of the singular features they display. Selected specimens of this kind lend themselves best to plain anecdotal presentation; and this method, though improper in a more scientific treatise, will here enable me to pass over the subordinate particulars that might, with a stricter concern for technical correctness, serve only to confuse the issue. Just for this very reason,

however, such instances, like all that are truly typical, are exceptional rather than usual. The common case is the complex case. In a footnote, therefore, I have always added a bald summary of the chief details ascertained. These abbreviated notes may interest and aid the expert student; and will remind the general reader how manifold, how interwoven, how liable to overlapping and reciprocal reaction are the factors involved in any given instance.<sup>20</sup>

To each section I shall append a brief epitome of the recommended lines of treatment. This, in a work on such a subject, is a new, but I hope not a premature, addition. In earlier publications there has been little or no attempt to summarize systematically the measures most likely to be effective. Innumerable handbooks<sup>21</sup> expound the ways in which young offenders may be disposed of under different statutes; but no published work, so far as I am aware, reviews the practicable methods for attempting to reclaim delinquent children, according to their mental or moral nature, and according to the physical, economic, or social difficulties of each. The recommendations set forth are no mere speculative suggestions. In compiling them I have been guided by concrete experience; and, throughout, the interest centers, not upon the alternative legal procedures, but upon the psychological principles involved. As a preliminary I have, so far as possible, sorted all my actual cases into causal types, and have then classified the recommendations made for each group with the greatest frequency and the greatest success. It is upon this summary that what I have to say here has been based. Again I must remind the reader that to make any presentation brief and intelligible, it is

---

<sup>20</sup> The footnotes are often as technical as they are copious; and the lay worker concerned more for the conclusions than for their evidence is advised to skip all save this. It is with great reluctance that, in the economy of space, I have often contravened one of my most cherished principles. Alike in the footnotes and in the text it has been found impossible always to keep separate the facts ascertained and the inferences drawn from them. This mingling of data and deductions would be inexcusable in any case history that was strictly scientific; in a semi-popular work like the present, it may perhaps be pardoned.

<sup>21</sup> The most helpful titles will be found set out in the bibliography at the end of the volume.



necessary throughout to simplify. Time and the unavoidable limits of administrative machinery demand simplification in practical treatment as well as in case analysis. To treat an individual as if he were one of a type will, indeed, be always precarious. Yet some classification there must inevitably be; and a causal classification is better than none whatever. Once more, however, it must be affirmed, mixed types and borderline cases are far more numerous than those that fit into any one pigeonhole or neatly drop into any single class.

## CHAPTER II

### HEREDITARY CONDITIONS

Crimes,  
Like lands, are not inherited. Therefore,  
Approach the fold and cull th' infected forth,  
But kill not all together.

SHAKESPEARE.<sup>1</sup>

#### The Inheritance of Crime

If our inquiry is to begin at the very beginning it must go back to influences that were operative long before the child himself was born. We must review not only his birth and early life, but his ancestry also; we must examine not only the moral qualities of the actual offender, but those of his father, mother, and remoter relatives as well. We must, in a word, compile his family history, and from such facts as it affords seek to divine what kind of hereditary traits his parents, and through them his distant forefathers, have handed on to him in the hour he was conceived. Jerry, we have seen, was the erring son of a fallen mother; and it has been plausibly maintained by many who know him that in this suggestive circumstance is to be found the clue to the whole enigma. The infant murderer, they claim, is a clear case of the born criminal.

Here, then, is the first and simplest hypothesis to offer itself for study—that crime is inherited or at least inborn. Just as the cat is always the offspring of a cat and the dog of a dog, and men gather no grapes of thorns nor figs of thistles, so, it is argued, the criminal tends always to reproduce his kind and the delinquent child is the foredoomed legatee of ancestral depravity and vice. If the analogy is a sound one, if inheritance is the sole and central key, then our theoretical questions are already solved, and the practical issue concerning the possibility

---

<sup>1</sup> *Timon of Athens*, V, iv, 37.

of reform is answered by a hopeless negative. What is inherited can never be uprooted; what is wholly inborn can never be cured.

### The Legal Conception of Moral Imbecility

These assumptions appear to receive some countenance from the English law. There is a mental condition which a recent Act of Parliament has recognized, and which it denominates "moral imbecility." If the criminal child is a criminal born, it should seem easy to deal with him as falling *ipso facto* within this legal category. But what is it that renders him morally imbecile in the eye of the law? As defined in the statute, moral imbeciles are "persons who from birth or from an early age display some permanent mental defect, coupled with strong vicious or criminal propensities, on which punishment has had little or no deterrent effect."<sup>2</sup> The definition, like all statutory

---

<sup>2</sup> *Mental Deficiency Act, 1913, Section 1 (d)*. In the definition of "moral imbecility," as originally suggested by the Royal College of Physicians, the perplexing phrase "mental defect" does not appear. Their definition commenced: "a person who displays from an early age, and in spite of careful upbringing, strong vicious or criminal propensities. . . ." The words italicized were dropped, and the words "mental defect, coupled with . . ." were substituted, by the members of the Royal Commission on the Care and Control of the Feeble-minded, 1908 (see their *Report*, note to Recommendation iv, sec. 6). The further qualification "permanent" was added later in the statute.

The phrase "from birth or from an early age," in the above and parallel clauses of the Act, is little more than a seven worded periphrasis for the single adjective "inborn." It indicates what older legal writers called *dementia naturalis*, or *nativitate*, as distinct from *dementia accidentalis* or *adventitia* (Hale, *op. cit. sup.*, Chap. iv, sec. 30, p. 29); it includes, that is to say, "natural incapacity" (for which the more usual Latin term is now not *dementia* but *amentia*), and it excludes "acquired incapacity," namely, insanity of whatever kind. The fact that the incapacity was actually inborn, however, could scarcely be proved to legal satisfaction. It is, indeed, and must be, not so much a fact as an inference. First-hand evidence for the early appearance of the defect, and first-hand evidence alone, is (as a Justice of the High Court has recently laid down) indispensable in fairness to the patient; a mere opinion that the defect has probably existed from birth or has probably been inherited cannot suffice; and first-hand proof dating from the moment of birth itself could seldom be forthcoming. Nevertheless, the incidental result of this broader wording—perhaps its actual intention—is that acquired deficiency, if it results from cerebral disease in early years (meningitis

definitions, needs interpreting; and its intention has been construed in at least two opposite ways. The words may mean, first of all, one who is primarily defective in intelligence, but happens, in addition, to possess an incorrigible propensity to crime, a propensity itself independent of, and superimposed upon, the essential defect of intelligence. But, secondly, the clause may bear, almost equally well, a totally different sense: it may denote a person whose incorrigible criminality is of itself enough to constitute, or is of itself the necessary result of, an inborn mental defect. With the former meaning, by a curious paradox of legal grammar, a moral imbecile would be an imbecile whose behavior is not moral; with the latter, he would be an intelligent person whose morals are imbecile. The difference is plain. The one is an immoral defective; the other is defective morally.<sup>3</sup>

---

or encephalitis during infancy, for example), also becomes included. Such cases, however, are rare. And it is plain, as Dr. Shruballs has pointed out (*Brit. Journ. Med. Psych.*, III, 1923, i, p. 187), that the primary and practical purpose of the law is that "an innate basis, as apart from habits derived from the social environment, must be proven." Dr. Mercier, who claims to have drawn up the definition, is even more decisive: he writes that "the mental defect must have existed from as early an age as it is possible to recognize it. It must in short be congenital" ("Moral Imbecility," *Practitioner*, XCIX, 1917, iv, p. 304). What is the latest age that can legally be regarded as "early," the High Court has not yet determined. Generally it appears to signify the earliest period at which the child comes under competent or official notice, that is, not later than the age of six or seven; the period of adolescence would assuredly not be accepted.

<sup>3</sup> In practice the former interpretation is generally adopted; in theoretical discussions there is now an increasing tendency to accept the second. The latter, too, is the interpretation that the psychologist seems bound to adopt, even if he doubts whether persons answering to this interpretation really exist. I myself have argued that in psychology the word "mental," both here and everywhere else, should strictly include what is "moral" or "temperamental" as well as what is "intellectual" ("The Definition and Diagnosis of Mental Deficiency," *Studies in Mental Inefficiency*, I, 1920, iii, p. 50). This, indeed, seems to have been the assumption of those who framed the definition (see Mercier, *Practitioner*, *loc. cit.*, p. 303; compare also footnote 13, p. 35). But if in the definition of the moral imbecile, mental includes moral, then it should also include moral in the definitions of the feeble-minded and of other types of imbecile; and hence there should logically have been no need either for a separate clause or for a separate definition to cover the so-called moral

Of the defective in the general sense—that is, of those who are subnormal intellectually, whether immoral or not—I shall treat in a later chapter. They do not concern us here. Our business, for the moment, is with inborn immorality (if there be such a thing) and with nothing else. Hence, it is the second interpretation alone that we now have to consider. We proceed, then, to ask—is it possible for any one to inherit, or at least to be born with, immoral or criminal propensities as part of his mental constitution? The answers to this question have been dependent as much upon theory as upon fact; and to understand the medico-legal conception of the moral imbecile, as it is held today, and to assess its true validity, we must glance first of all at its historical origin.

### The Philosophical Conception of a Moral Sense

The notion that morality and immorality are native qualities of the mind is one that has been put forward from time to time, for the most part by writers in this country. It was advocated first by English philosophers and has been revived more recently by English medical men. For the faculty thus postulated the old philosophical name is “the moral sense.” And the doctrine itself was enunciated most clearly by a school of ethical thinkers who flourished in the seventeenth and eighteenth centuries. They are known as the intuitionists.<sup>4</sup> “Should one,” says Lord Shaftesbury, the chief exponent of this group; “should one who had the countenance of a gentleman, ask me: ‘Why I would avoid being nasty when nobody was present?’ in the first place, I should be fully satisfied that he himself was a very nasty gentleman who could ask this question. . . . However,

---

defective; he could have been certified as mentally defective under one or other of the preceding definitions. For this further insertion, however, Dr. Mercier personally pressed, because, so he states, magistrates and certifying officers would have been prone to think only of “intellectual” defect, unless explicit sanction had been given.

<sup>4</sup>Historically the tenets of the intuitionists were, in effect, a reaction from the materialistic doctrines of Hobbes. In opposition to the view that moral knowledge was a calculation of pleasures or pains or a reasoned deduction from first principles, they desired to show that it was a direct and specific intuition and so uphold its objective validity.



I might give him a slight answer, and say: 'Twas because I had a nose.' Should he trouble me further, and ask: 'What if I had a cold?' I might answer perhaps: 'That I cared as little to see myself nasty, as that others should see me in that condition.' 'But what if it were in the dark?' Why, even then, though I had neither nose nor eyes, my *sense* of the matter would still be the same."<sup>5</sup> Shaftesbury thus argues for the existence of an intuitive faculty or "sense"—an ethical taste which perceives what is moral or immoral, much as the nose can smell what is odorous or noisome, or the eyes can see what is visible, ugly or fair; it is, in fact, a kind of inherited conscience. The theory is far too simple to be sound. To explain how I come to make moral discriminations, by merely positing a capacity to discriminate what is moral, is no explanation at all; it only restates the fact. "We may as properly," cried Locke half a century before, "say that it is the singing capacity that sings, and the dancing faculty that dances."<sup>6</sup> And when this supposed capacity is called, half literally and half in rhetorical metaphor, a human "sense," and is declared to be innate like the sense of smell or vision, we ask at once—where is the corresponding sense organ? Are we born with a moral nose or a moral eye? Do special nerve fibers conduct these moral impressions to the brain? Is there even, within the brain itself, any region or center which subserves such moral percepts or sensations, just as localized brain areas are known to subserve the truly sensorial consciousness of odor and of sight? We know there is none. For morality man has neither nerve nor center, neither sense organ nor sense. Ethical perceptions, ethical judgments, ethical acts—these are all complicated feats of the whole developed mind, processes whose slow evolution we can follow, step by step, in the race, in the nation, and in the child. No reputable psychologist would now venture to support so primitive and figurative a view.<sup>7</sup>

<sup>5</sup> *Characteristics of Men and Manners* (1711), Pt. I, sec. iv (5th ed., Vol. I, pp. 124-5).

<sup>6</sup> *Essay on Human Understanding* (1690), Bk. I, Chap. iii.

<sup>7</sup> The only modern philosopher to maintain it is Dr. Hastings Rashdall who postulates an *a priori* faculty, which he terms the "moral consciousness," making it the keystone of his ethical position. So many

"But sure, Herr Pastor," said the German peasants, when shown the intricate machinery of a locomotive: "sure there be a horse somewhere inside?" And the easy invocation of a simple moral faculty "somewhere inside" to account for the outward behavior of what is really a complex moral organism, seems too attractive to be cut short by an argument. In the medical writings of the past fifty years it has found a new vogue.

### The Medical Conceptions of Moral Insanity and Moral Deficiency

The traditional accounts of deficiency and insanity, as given by medical writers of this country, were in their earlier forms far too intellectualistic. They treated the normal man as a rational being, no more and no less. Early in the nineteenth century, however, a move was made to separate from the more obvious forms of mental disorder, that is, from mere derangement of the intellect, another form in which reason was unaffected and morality alone impaired. To this newly recognized form the name "moral insanity"<sup>8</sup> was applied. As a result of disease, it was contended, a patient might lose his moral sense while retaining his intellectual powers intact.

With the further progress of medical psychology a second distinction was soon introduced. If some seemed to lose their senses in later life, others seemed never to have developed them: much as some plants—the primitive ferns and fungi—can never come to flower, while others—the lily, the lilac, or laburnum—having budded and blossomed in due season, may have had their

---

scientific writers who touch upon this subject seem wholly unaware both of the newer psychological objections and of the older philosophical arguments against the so-called "moral sense" school, that it may be worth while naming some standard discussions of the matter: for example, Mackenzie, *Manual of Ethics*, Chap. iii, sec. 8; Taylor, *The Problem of Conduct*, Chap. iii; Dewey and Tufts, *Ethics*, pp. 318-24; McDougall, *Social Psychology*, pp. 213-27, and especially p. 229.

<sup>8</sup> The term was first formally proposed by J. C. Prichard, in his *Treatise on Insanity* (1835, p. 12). The earliest accurate description of such a case he attributes to Pinel (*Traité Médico-Philosophe sur l'Aliénation Mentale*, 1809, p. 156); the word "moral" was used by Prichard in rather a wide sense, to include mere emotional disorders as well as those marked by vicious and criminal conduct.

blooms frozen off. Lack of mind was thus distinguished from loss of mind, *amentia* from *dementia*; and while *dementia* or insanity was attributed to the ravages of disease in after years, idiocy and imbecility were attributed to a permanent defect, hereditary or at least inborn. Those who had already drawn a sharp line between the intellectual faculties on the one hand, and the moral sense on the other, were thus led, by this further cross-division, to divide the morally deficient from the morally insane, and both from all other kinds of mental defect and disorder. Nowadays insanity of whatever sort is seldom diagnosed in children of school age; hence, dealing as we are here with juvenile crime alone, we may brush aside the alleged existence of moral insanity and confine ourselves to the conception of moral defect as reached by this double distinction.

The acceptance of this category and its application to the problems of criminal responsibility have grown chiefly out of the teaching of Dr. Henry Maudsley.<sup>9</sup> It is the contention of Maudsley and his followers that many, perhaps most, young criminals are morally defective; and by morally defective they mean defective in "the common power of forming moral intuitions." This defect, they hold, must itself be inborn and may be accompanied by defects in no other direction; intelligence, indeed, may be perfectly normal, or even exceptionally high. They resuscitate the old analogy with the physical senses of taste or vision, explaining that there are certain children who, though clever in a superficial way, are yet "morally blind, just as other children are physically blind"<sup>10</sup>; and that "as there are persons who cannot distinguish certain colors, and others who, having no ear for music, cannot distinguish one tune from another, so there are some who are congenitally deprived of the moral sense."<sup>11</sup> Finally, most of these writers lay great stress upon the fact that this inborn moral deficiency seems to run in certain families and to be indeed inherited.<sup>12</sup>

<sup>9</sup> *Responsibility in Mental Disease* (1872); see especially pp. 31-65.

<sup>10</sup> M. W. Barr and E. F. Maloney, *Types of Mental Defectives* (1921), Chap. vi, "Moral Imbeciles," p. 74.

<sup>11</sup> Maudsley, *loc. cit.*, p. 58.

<sup>12</sup> *E.g.*, Maudsley, *loc. cit. sup.*, p. 60, and Tredgold, *loc. cit. inf.*, p. 323.

This, then, is the conception that has been introduced into English law. Its insertion was mainly due to the late Dr. Mercier. Quite explicitly he declares that children of the type we are considering owe their delinquency to an inherited or congenital defect in this unique moral faculty, which the human species is supposed to have evolved; and the majority of them, so he argues, should be dealt with upon the same principles as other children who are admittedly defective in reason or intelligence.<sup>13</sup>

More recently still, in what is probably the best textbook upon mental deficiency, Dr. Tredgold has once again employed the terms of the same antique philosophy to explain the medico-legal concept that has thus become part of the law. The morally deficient, he says, are those who are "fundamentally lacking in the moral sense." He adds that "the condition is inborn. . . . And this . . . causes them to be absolutely irreformable."<sup>14</sup>

<sup>13</sup> In the article on "Moral Imbecility," already quoted (*Practitioner, loc. cit. sup.*, pp. 301-8), Dr. Mercier states: "It was I who invented this term and formulated the definition of it which was adopted successively by the Royal College of Physicians, the Royal Commission on the Feeble-minded, and by Parliament." The claim, however, cannot be taken too literally. The term "moral imbecility" was used by Prichard (*op. cit.*, 1835, p. 10) in translating and simplifying Heinroth's classification of mental disorders. Heinroth's own term, indeed, is merely *Blödsinn mit Willenlosigkeit* (*Lehrbuch der Störungen des Seelenlebens*, 1818, p. 271). But a contemporary of his, Professor Grohmann, uses the phrase *Moralische Blödsinn*, which he defines as *angeborene moralische Irresinn* (*Criminal-Psychologie*, 1799), and is said by Krafft-Ebing to have been the first continental writer to have used this term (*Lehrbuch der Psychologie*, 1879, Bd. II, p. 65). The phrase "moral imbecility" is used and defined by Maudsley (1872, *loc. cit.*, p. 58), and by Hack Tuke (*Dict. Med. Psych.*, 1892, *s.v.* "Moral Insanity"); and the phrase "moral defect" is used in the same sense by Clouston (*Clinical Lectures on Mental Diseases*, 1887, p. 350) and by several writers of last century. Further, the essential phrase "mental defect" which Mercier states was "advisedly inserted" by him into the definition of moral imbecility was either introduced, not by Mercier, but by the members of the Royal Commission, or else not accepted from Mercier by the Royal College of Physicians (see footnote 3, p. 30).

Nevertheless, the acceptance of the clause as a whole seems mainly to have been the result of Mercier's advocacy; hence his paper must be regarded as authoritative in its bearing upon the interpretation of that clause.

<sup>14</sup> *Mental Deficiency* (2nd ed., 1914), p. 326. Tredgold recognizes four

It is his belief that "in the race the moral sense is the last to have been evolved; and it appears also to be the last to make its appearance in the individual." Hence it would seem to follow that "persons so constituted as to be utterly devoid of this potentiality" are likely to be more numerous than persons devoid of other faculties that are developed earlier—as the rational or intellectual; for in human life as in animal evolution the latest acquired is the soonest lost.

### The Anthropological Conception of Moral Degeneracy

By this theory, it will be seen, moral defects are presumed to be quite independent of defects of intelligence. In point of fact, however, there is admitted to be some small correlation.<sup>15</sup>

---

such "senses," the other being "the religious," "the æsthetic," and "the logical." These also seem a legacy from the "moral sense" school of philosophers, who recognized as many as half a dozen, adding examples so flagrantly metaphorical as a "sense of honor" and a "sense of the ridiculous"—all seemingly coördinate with what they literally recognized as the "external senses" (cf. Hutcheson, *Essays on the Nature and Conduct of the Passions, with Illustrations on the Moral Sense*, 1742, sec. i, 3rd ed., pp. 5-6).

It is only just to add that Dr. Tredgold has since restated and revised his view. In a paper on "Moral Imbecility" (*Practitioner*, XCIX, 1917, Vol. I, p. 51), he recognizes two forms of moral imbecility, the one characterized by "defect of moral sense" and the other by "defect of will" such as is found in compulsion neuroses (see below, Chapter XII). In the last edition of his work, however, from deference to Dr. Mercier's criticism (*Practitioner*, *loc. cit.*, p. 307), he appears to lay less stress upon this second form; and in his recent chapter on moral imbeciles, he states that there are "two qualities which invariably distinguish them: one is their lack of moral sense, the other their lack of wisdom" (*Mental Deficiency*, 4th ed., p. 388. The new distinguishing quality—lack of wisdom—seems also to have been suggested by Dr. Mercier: see *loc. cit. sup.*, pp. 303 *et seq.*). In the main Dr. Tredgold has now brought his statement more into accord with contemporary psychology by emphasizing the importance of instinct in all human conduct (*ibid.*, p. 265). My quotations from his earlier edition, however, I leave as they stand in the text; for they express, with Dr. Tredgold's inimitable lucidity, views still widely held among medical practitioners.

<sup>15</sup> Some writers go further. In contrast to the views of Dr. Mercier and Dr. Tredgold it is the opinion of Dr. W. C. Sullivan (Medical Superintendent at Broadmoor Criminal Lunatic Asylum) that "the moral imbecile is not simply an a-moral person; he is an a-moral person who presents also some degree of intellectual deficiency" ("Crime and Mental Deficiency," *Lancet*, October 15, 1921, p. 787). Dr. Sullivan



And according to those who most logically extend the hypothesis of heredity, the arrest in moral development appears in most instances only as a portion of a more general arrest, as part of a widespread immaturity affecting the whole man. Hence it is argued that the so-called "moral imbecile" is earmarked by numerous defects, or at least by numerous peculiarities, of intellect as well as of morality, of body as well as of mind. It is, moreover, alleged that the nature of these distinctive symptoms, when taken one with another, is such as to suggest that the moral defective is a biological throw-back or reversion—a return by some freak of inheritance to a primitive or even a pre-human type. To describe these moral anachronisms—these pre-historic creatures cropping up in a civilized world—the term "degenerate" has been proposed<sup>16</sup>: and the more conspicuous

---

seems to own that, pushed to its logical conclusion, this interpretation of the legal definition would render the clause itself superfluous and place the moral imbecile in the category of the feeble-minded (*ibid.*, p. 780)—a conclusion to which we seem ultimately forced, whatever interpretation we accept. After all, are not "persons who display some permanent mental defect" *ipso facto* mentally defective, no matter what propensities their defect may be "coupled with"?

Recently in an excellent treatise which should be in the hands of all (*Crime and Insanity*, 1924), Dr. Sullivan has repeated his general view. To judge, however, from his further comments, he appears in practice to lay less emphasis on intellectual deficiency than his pronouncements seem to convey. He is content to look, in certain patients, only for "some amount of intellectual debility," as distinct from "definite intellectual deficiency"; one, for example, has a mental age "over 12 years in the Binet-Simon Scale" (*op. cit.*, p. 193). Unlike the moral imbeciles described by most other writers, the cases that he offers show, nearly all of them, well-marked psychopathic or psycho-neurotic symptoms. Further, he includes under the heading of moral imbecility "one large group of defective criminals, namely, the pathological swindlers" whose "intelligence is, as a rule, of a fairly high level." These most investigators would be disposed to class, if they classed them at all, with the psychopathic or hysterical, not with moral imbeciles. Dr. Sullivan, indeed, himself observes elsewhere (p. 180) that "in many instances, the distinction [between hysteria and moral imbecility] can hardly be made."

<sup>16</sup> The conception of mental degeneracy was first systematically formulated by B. A. Morel, *Traité des dégénérescences physiques, intellectuelles, et morales, de l'espèce humaine* (1857). For a full and recent treatment of the subject see Talbot, E. S., *Degeneracy: Its Causes, Signs, and Results* (Contemporary Science Series, 1898). Maudsley and Mercier, in formulating their conception of the moral imbecile, have avowedly been influenced by Morel's conception of degeneracy; but the English

of their physical features—the slanting eyes, the projecting ears, the misshapen head with its low and sloping forehead and its dark and frizzled hair, the protruding, ape-like face with its snub nose, square jaw, and weak, receding chin—are spoken of as the stigmata of degeneracy. By such outward and visible signs, it has been claimed, the atavistic mind can be marked down at a glance.

'Tis the blot upon the brain  
That will show itself without.<sup>17</sup>

### *The "Born Offender"*

Of all the exponents of this wider view, the most systematic and the most influential was Cesare Lombroso, Professor of Legal Medicine at the University of Turin, the father, as he has been called, of criminal anthropology. He and his school collected wholesale observations and carried out the most elaborate physical measurements, by which they proved, or thought they proved, that the criminal is marked off by many well-defined characteristics from the normal law-abiding mass of humanity; that he forms, in fact, a species apart. They were thus led to the belief in a congenital criminal type—*il reo nato*, the born offender. They depicted him as a man who, by inheritance from some ancestor, whether parent or close relative, or (more often) some primeval progenitor almost infinitely remote, is sent into the world devoid of all moral feeling, and betrays himself immediately to the expert eye by a combination of gross pathological traits, both of body and of mind.<sup>18</sup> The English notion of a person defective in moral sense and the Italian notion of a person inheriting a criminal nature are thus very nearly akin; and the two have been expressly identified by Havelock Ellis.<sup>19</sup>

---

conception has always been clearer, narrower, and more strictly circumscribed than the Continental.

<sup>17</sup> Tennyson, *Maud*, XXVI, 8.

<sup>18</sup> *L'Uomo Delinquente*, 5th ed., 1906-7. The most convenient English summary is to be found in *Criminal Man*, by Lombroso's daughter, Gina Ferrero (Science Series, 1911).

<sup>19</sup> "We must regard the group of moral imbeciles as identical with the congenitally criminal" (*The Criminal*, 4th ed., 1910, p. 292).

Ellis, among all the upholders of these and cognate theories, presents the most sane, the most lucid, and the most impartial account. His book upon *The Criminal* is still the best survey of the subject that has issued from this country. His final conclusions upon the whole position are summarized in the following terms: "It is becoming generally agreed by those who are entitled to speak with authority that the criminal tends to be marked by a certain mental weakness that usually affects less noticeably the intelligence than what we often improperly term the 'moral' character; his intelligence is relatively, and even in some cases completely, unimpaired." He quotes a recent estimate of a Commissioner of English prisons, alleging "that from 10 to 20 per cent of the total number of persons committed to jail are 'demonstrably mentally defective'"; and goes on to infer that "the nucleus of this large class is formed by the pronounced '*moral imbecile*,' sometimes called the 'born criminal.'" <sup>20</sup> To illustrate how the inborn moral sense may be almost lacking while the intelligence remains intact, he refers to the many instances of criminals of genius, men whose names have become bywords in the annals of human crime. One or two of the better-known cases are worth describing at length that the reader may receive some concrete picture of what a talented degenerate is taken to be.

*Illustrative Cases.*—The classical example of the intellectual criminal is Thomas Wainewright <sup>21</sup>—poet, painter, art critic, and antiquarian—a forger of wills, and the most callous poisoner of modern times. Wainewright was born "of a failing and degenerating stock." In late adolescence he was attacked by some morbid "trouble of the nerves"—apparently an anxiety neurosis. Under the appropriate pseudonym of *Janus Weathercock* he contributed numerous essays, in a style all his own, to the literature of his day. Oscar Wilde, a kindred spirit, has hailed him as "the pioneer of modern Asiatic prose," and

---

<sup>20</sup> *Op. cit.*, Preface to 4th ed. (1910), pp. ix-x.

<sup>21</sup> 1794-1852. The best account of his life and writings is to be found in Oscar Wilde's *Intentions*, "Pen, Pencil, and Poison," pp. 53-8. Wilde bases his narrative on W. C. Hazlitt's biography, prefixed to Wainewright's *Essays and Criticisms* (1880).

declares that "modern journalism owes almost as much to him as to any man of the early part of his century." For a time the rising critic startled the town as a dandy, and his lemon-colored gloves, his cameo breastpin, and his exquisite onyx rings were acclaimed by Hazlitt as the colored symbols of a new æsthetic cult. He was among the earliest admirers of Shelley and Keats, and later became the intimate friend of Charles Lamb. As a collector of art curios—of Greek gems and Persian carpets, of ancient statuettes and modern engravings by such contemporaries as Turner and Blake, he achieved great fame. His end came suddenly. To find money for his collection he forged a power of attorney for several thousands of pounds. After a long delay he was tried, convicted, and transported to the felons' settlement at Van Diemen's Land, where fifteen years afterwards he died in an apoplectic fit.

When his trial was over he made a boast of his many accomplishments in forgery and poisoning, crimes long suspected but till then unproved. His first victim apparently had been the uncle who had brought him up. A year later he murdered his wife's mother, and in the following December he poisoned his sister-in-law, Helen Abercrombie, a young woman, of some renown as a beauty, who had been heavily insured against death. Suspicions were aroused and he was forced to flee to France. At Boulogne he induced the father of his mistress to insure himself for £3,000, and then, as they sat together one evening after dinner, dropped some crystals of strychnine into his guest's cup of coffee. Even in the convicts' colony he tried to make away with two fellow-prisoners who had offended him. Of his numerous victims, many were murdered solely for gain; others for revenge; others, it would seem, "either from a mere caprice, or perhaps to quicken some hideous sense of power that was in him, or possibly for no reason at all."<sup>22</sup> Reproached one day with the murder of the handsome Helen, he shrugged his shoulders and replied: "Yes, it was a dreadful thing to do; but then, her ankles were so thick." Dickens came across him in jail and made him the hero of his story, *Hunted Down*; in

---

<sup>22</sup> Wilde, *loc. cit.*, p. 73.

Lytton Bulwer's *Lucretia* he figures as Varney. All who knew him looked upon him as a type of inborn genius combined with an equal measure of moral insensibility.

A second instance, also cited by Havelock Ellis, interests us perhaps more nearly. It is that of a young and clever child. Marie Schneider, a little German girl of 12, was condemned to eight years' imprisonment for the murder of a younger playmate. She had against her name a long list of heartless cruelties and was considered by the various physicians who examined her to be a "moral idiot." Unlike the talented adult, she was not old enough to leave behind her any lasting proof of high ability; nor were there, in her day, any mental tests sufficiently refined to demonstrate her intellectual level. We are, however, assured that she was bright beyond her years; and her own account of her history and her misdoings, uttered at her trial with no trace of fear or regret and preserved in what purports to be a verbatim record, is that of a shrewd and logical child. She relates how she used to torture her schoolfellows, and how, when a little child, she "stuck forks in the eyes of rabbits and afterwards slit open their bellies." "One day I met little Margaret, and wanted her earrings to sell at a shop to buy cakes. I pulled out her earrings and she began to cry. I thought I would kill her because I was afraid she would betray me. So I put her on the window ledge and gave her a push, and heard her strike first the lamp and then the pavement. I knew I should kill her, but I was not sorry. I was not sorry all the time that I was in prison. I am not sorry now." Bystanders noted that she found a childlike satisfaction in being able to give such full answers to such long questions, and to tell her own tale so well.<sup>23</sup>

The scientific literature of recent days contains no cases exactly analogous to those I have just described. Healy, in his studies of a thousand juvenile delinquents, finds not a single moral imbecile.<sup>24</sup> In almost every case description adduced by

---

<sup>23</sup> Friedreich's *Blatter f. gericht. Med.*, XXXVIII (1887), p. 266.

<sup>24</sup> His statement is trenchant enough to be quoted in full. "When we began our work," he writes, "there was no point on which we expected more data. We have been constantly on the lookout for a moral



contemporary supporters of this doctrine to illustrate what they regard as moral imbecility, some measure of intellectual defect is avowedly present.<sup>25</sup>

Jerry is typical of the sort of case that is thus put forward. Testing him with the usual psychological tests, I found his intelligence at the age of 7½ to be that of an average child of only 5½.<sup>26</sup> Distinctly dull for his age, therefore, he was nevertheless above the borderline for intellectual deficiency<sup>27</sup>; he could not, for example, be recommended for a special school. In educational attainments, owing to illness and absence, he was

---

imbecile—that is, a person intact in mental powers, but devoid of moral feelings. Many cases have been brought to us as such. We have not found one.” (*Op. cit.*, p. 783.)

<sup>25</sup> The best case studies of “moral imbeciles” are the thirty-eight collected, with photographic portraits, in the volume on *Types of Mental Defectives*, compiled by Barr and Maloney (1921). Of the cases described the lowest were evidently ineducable; the majority could barely read and write; and all but one or two of the “high-grade” examples would seem to have been certifiable on the ground of deficient intelligence alone. They are, as the writers themselves point out, “defective delinquents”—that is, for the most part, imbeciles or defectives who happen also to possess criminal habits.

Tredgold, under the heading of moral deficiency, describes children practically all of whom conform to this double description: they are what he elsewhere terms “criminal aments.” Thus, No. 1, George P., is 13½ and in Standard [grade] I; Nos. 2-4 are three “cases culled from newspapers” . . . “all reported” (by the school board or otherwise) “to be mentally defective,” as well as delinquent; No. 5, Rose T., left school at 15, in Standard [grade] II; No. 6, George A., “cannot read, write, or sum”; No. 7, Thomas B., “could never learn at school”; No. 8, H. A., was a “feeble-minded deaf-mute.” He concludes with an account from *The Daily Telegraph* of another German girl—a story at first sight recalling that of Marie Schneider. At the age of 13 she had committed six murders, all by plunging a hairpin into the skulls of infants in her charge. But she, unlike Marie, was not intelligent but “dull-witted”—possibly, therefore, again defective intellectually. (*Op. cit. sup.*, pp. 328-36).

<sup>26</sup> About six months later he was examined at the Tavistock Clinic by Dr. Potts and Dr. Hamilton Pearson. He was then given a mental age of rather more than 6, which sufficiently accords with my own previous finding; it is interesting to note that examiners of such experience independently reported that the boy was “not certifiable as a moral imbecile.”

<sup>27</sup> Whether in view of his unstable temperament he falls into the group I should term “temperamentally defective,” is a question I shall return to later on.

far behind. He could read nothing but three or four two-letter words—such as “to,” “is,” “at,” “up”; many of the letters of the alphabet he failed to name. In counting and calculating he was likewise still at the initial stages of a baby of four or five.

In cases such as those I have culled from earlier writers, the bare fact that thefts and cruelties so numerous, so ceaseless, and so callous, should be deliberately contrived by persons of such high intelligence has been treated time after time as a sufficient proof of moral defect, a sure and self-evident token of an inborn depravity. Teachers and social workers, when requesting a psychological examination for some delinquent child, still use the same fallacious argument. “No girl,” they write in their reports, “who was not inherently abnormal would dare to do such deeds.” Or again: “The boy’s spitefulness and incorrigible thieving are obviously born in him; he evidently takes after his uncle; and ought to be certified as he was.” Or—the commonest phrase of all—“The child has clearly inherited some kink in the brain.”

This doctrine, then, of an innate lack of moral sense is plainly one with which the psychologist has seriously to reckon. But a mere surmise, a mere impression, or a mere *a priori* argument, he cannot accept as cogent or conclusive. Hereditary and congenital traits are not to be deduced solely from the nature of the criminal actions themselves, however abnormal or persistent. They can only be inferred, and then not always with certainty, from the presence of similar traits in the child’s parents or kinsfolk.

### Criminal Pedigrees

Our first duty, therefore, is to examine our collection of delinquent cases and find what verifiable evidence there may be to show that vicious or criminal propensities were preëxistent in the father, mother, or remoter relatives of each vicious or criminal child. To study the parents alone will not be enough, for it is often alleged that mental and physical peculiarities, like Mendelian traits, may skip a generation. Nor should we confine ourselves to relatives in a direct ascending line. The collateral kindred—uncles and cousins, for example—may throw

light on qualities which are being carried, as it were, in solution by the whole family stock, and which crystallize out and become visible only among the outlying branches. It is possible, and, indeed, we shall find it more than probable, that the trait actually bequeathed may be no moral taint at all. It may consist in some underlying weakness which, though it favors a criminal tendency, is not itself a tendency to crime; just as in physical diseases like gout or consumption, what is biologically transmitted from parent to child is not the actual malady but merely the predisposition. Accordingly, in every case to be recorded for subsequent analysis, it is essential, wherever it is practicable, to inquire exhaustively into all the failings of all the known relatives.

Jerry's mother and grandmother were entirely innocent of murder, and had neither of them committed any penal offense: for the rest, his antecedents are unfortunately not preserved. In this case, therefore, the pedigree is incomplete and negative. Nor do the earlier cases brought forward by Havelock Ellis possess any ascertained history of ancestral crime. We must turn elsewhere. There are, as it happens, several lawless fraternities which have lately been investigated in much detail, chiefly in the United States. Of these the so-called Jukes family, with a chronicle of convictions reaching back to 1720, is the most notorious. The forefather of this little clan was a backwoodsman in the hill regions 200 miles from New York. His descendants have been traced through nine generations to the number of nearly 3,000 individuals; and among them as many as 34 per cent were discovered to have been paupers, prostitutes, vagabonds, or thieves.<sup>28</sup>

---

<sup>28</sup> R. L. Dugdale, *The Jukes: A Study in Crime and Heredity* (1877) —a research that originated during an inspection of jails for the New York Prison Association, and was first described in their *Thirty-first Annual Report*; the inquiry was later extended by Eastabrook in his work on *The Jukes in 1915*, published by the Carnegie Institution of Washington, 1916. Eastabrook and Davenport in their investigation of *The Nam Family* (1912) and Goddard in his investigation of *The Kallikak Family* (1912) give similar genealogical studies of mental weakness and crime.

From the Jukes's pedigree the true conclusion was drawn by Galton when he wrote, "The ancestor of all this mischief was a somewhat good

In the following chart, I give two genealogical tables which show how, in different members of the same family, criminal habits are found emerging time after time. Of such cases as these, one of the most striking I have met with may well be recounted at length. A little girl named Grace was first sent to me by the mistress of an infants' school with complaints of repeated theft and of continual spitefulness towards her tiny playfellows. She had stabbed a neighbor's baby with an inky pen. She had twice bitten the child sitting next to her in class until she had drawn blood. She had flung, in a spasm of rage, her own pet kitten on the fire. She had waylaid younger children on errands for their mothers and had terrified them till they handed over the coins intended for the shopman—a repetition of the tactics described by the Artful Dodger as the "Kinchin lay."<sup>29</sup> When I first saw her, she was barely seven, and in appearance far from captivating. She had a fixed and foolish leer, and her head and features showed several slight anomalies which might have been fastened upon as stigmata of degeneracy. Her forehead was bossed, her nose pinched and undeveloped, her palate high, and her teeth misshapen and irregularly packed.<sup>30</sup> In infancy, however, she had suffered from rickets, and at the time of the examination was troubled with

---

specimen of the half-savage, without any seriously criminal instincts; but the gipsy-like character of the race was unsuited to success in a civilized country: so the descendants went to the bad" (*Inquiries into Human Faculty*, 1883, p. 44). It was the marked criminality of the stock which led Dugdale to study them. But since his inquiry, and with the gradual dispersal of the survivors, the criminality of the stock has relatively diminished. Eastabrook concludes that licentiousness, feeble-mindedness, vicious temper, and perhaps intemperance rest on hereditary factors; but that there is "no good reason for regarding criminality as a unit biological trait" (*loc. cit.*, p. 64).

The two later genealogies—of Nam and of Kallikak—are really studies in the inheritance, not of a criminal nature, but of feeble-mindedness. In all such cases, as we shall presently see reason to argue, the recurrence of crime is but the secondary outcome of other weaknesses, far more fundamental and universally acknowledged to be inheritable.

<sup>29</sup> Dickens, *Oliver Twist*, Chap. xlii.

<sup>30</sup> Her mental and scholastic level is not relevant except to show that she was far from defective in intelligence. Mental age: at 7.0 years, 6.4; at 14.8 years, 12.2. Educational age: at 7.0 years, 4.5; at 14.8 years, 11.15 (Wassermann test, negative).

severe nasal obstruction. Shortly afterwards adenoid growths were removed, and she was sent for a prolonged holiday in the country; then gradually, as she grew up, these small disfigurements, like most deformities due to early rickets and respiratory difficulty, all but disappeared. By the age of fifteen she had developed into an attractive, well-made, normal-looking girl with a ready tongue and animated ways. Throughout this period her stealing, violence, and intractable conduct had persisted and even increased. At length she was charged with accosting men in the street. She was committed to a residential institution. But five days later she attempted to escape by climbing down a water pipe; she fell twenty feet and broke her leg. Many kind acquaintances, drawn by her appealing looks and plausible manner, both before and since this culminating episode, have taken a deep interest in the child. They have offered her one chance after another to lead a quiet life in a comfortable home. But from her earliest infancy down to the present day she has exhibited, with a remarkable consistency of career, the ineradicable habits of a hopeless moral reprobate.

What is her family history? She is an only child, the unwanted daughter of a daughter of the streets. Her father was a young French waiter, three times arrested, twice for burglary and once for trafficking in cocaine. His father, in turn, the child's paternal grandfather, was a refugee from Paris; and it was whispered that his flight to England was the sequel to a fatal blow. On this side of the family one other member only is known by first-hand acquaintance—the younger brother of Grace's father—a drunkard, a drug-taker, and a professional pickpocket. He, however, is in communication with two cousins in France who appear to be perpetually in and out of jail; they are reputed to belong to a gang of coiners—a trade (he says) handed down to them through several generations. The child's father was not married to the mother; he was merely her self-constituted protector, which meant that when out of work he lived on her takings. The mother herself was a thief and a prostitute, and her only brother and sister in their earlier years had both been sent to industrial schools for truancy and stealing. The mother of these three, the





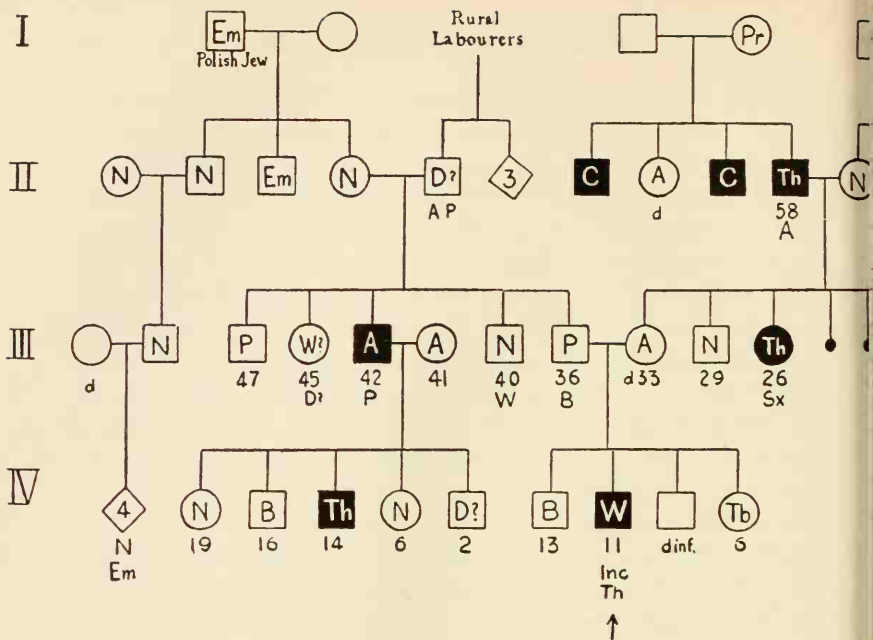

FIG. 2. PEDIGREES OF JUVENILE DELINQUENTS, CASE 1

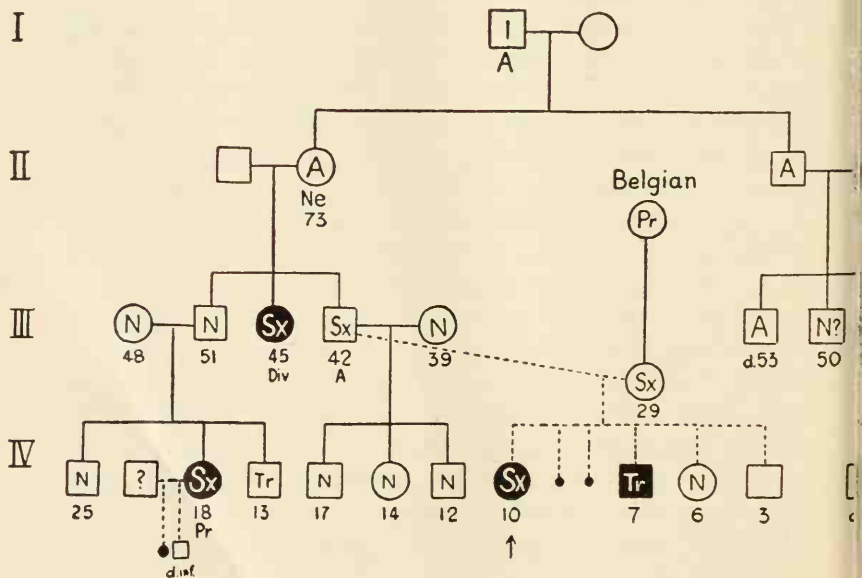

FIG. 3. PEDIGREES OF JUVENILE DELINQUENTS, CASE 2

## KEY TO SYMBOLS

□ = Male.

◇ = Sex unknown.

○ = Female

■ or ● = Committed to prison or Home Office school for delinquency

⋮ = Unmarried or illegitimate.

● = Miscarriage or still-birth.

A = Alcoholic.

N = Normal intellectually and morally.

B = Backward or dull.

Ne = Neurotic.

C = Criminal: charge unknown

P = Pauper.

D = Mentally defective.

Pr = Prostitute.

d = Died.

Tb = Tubercular.

Div = Divorced.

Th = Theft.

Em = Emigrated.

Tr = Truancy.

I = Insane.

W = Wandering, vagrancy, running away.

Inc = Incurable.

inf = Infant.

Roman numerals = number of generation.

Arabic numerals under symbol = present age.

Arabic numerals in symbol = number of children.

↑ indicates case referred for psychological examination, as described below

### SUMMARY OF CASE-HISTORIES

*Case 1.*—Boy, aged eleven. Charged as incorrigible. Wanders away after school; steals from maternal uncle with whom he lives. Weak health. Intelligence below average, but not definitely dull or backward (mental ratio, 90). Unstable, irritable temper.

Father, illiterate, in workhouse. Mother, married at eighteen, drunkard, died nine months ago.

Father's family. Paternal grandmother descended from a Polish Jew, five of whose descendants have emigrated. Paternal grandfather, a drunkard and pauper, apparently feeble-minded. Their descendants show tendencies to alcoholism, pauperism, and vagrancy, several being dull or borderline defectives. One paternal cousin is in an industrial school for theft.

Mother's family. Maternal grandfather, a heavy drinker, imprisoned for theft; two of his brothers have also been in jail. Their mother is said to have been a prostitute. The boy's maternal aunt has been in jail for theft, and is at present the mistress of a Chinaman. There is a tubercular strain on this side of the family.

*Case 2.*—Girl, aged ten, illegitimate. Charged with sex offences.

Father, a heavy drinker, married to a respectable and intelligent woman; their legitimate children are normal in character and intelligence. Mother, a Belgian waitress; has had four children by this man, the first before she was nineteen.

Father's family: Paternal great-grandfather said to have been alcoholic and insane. Neurotic and alcoholic tendencies appear in several of his descendants. Every one of his female descendants has shown sexual misconduct, one being a prostitute from the age of sixteen. A hysterical girl of seventeen, who was later referred to me for repeated theft and sex delinquency, proved to be a member of this family: the only son of the great-grandfather had married a woman who had constantly been in jail for stealing; her daughter in turn had three illegitimate children, of whom this child was one. Later, a brother and a paternal cousin of the girl originally brought to me were reported for truancy.

Mother's family: Maternal grandmother a prostitute from Brussels.

Tb  
2  
N

4  
N?

Sx  
44

Sx  
Ne  
Th  
17

N  
12



maternal grandmother of Grace, was a hardened profligate of fifty-four, who boasted that she herself when a girl had "earned every shilling without working"; and in turn gave credit for her proficiency to her own mother (the child's great-grandmother) who had, she averred, brought up four dissolute daughters to the same traditional trade. This great-grandmother was the ancestress of thirteen persons including Grace herself; out of these thirteen only one has failed to attain notoriety for a series of criminal offenses, and that one is a baby of three.

This history is somewhat more complete than the rest. But doubtless every social worker could quote similar records from his own particular experience. The bare facts, then, are hardly to be questioned. That a delinquent child may have delinquent ancestors, and prove on investigation to be merely one member among a whole brood of felons and rogues, may be accepted as common ground. The next step is to discover how far such pedigrees are isolated exceptions, and how far they are typical of the general rule.

### The Relative Frequency of Hereditary Conditions

Going through my own collected case sheets, I have catalogued every relevant feature in each child's family, every characteristic which might be supposed to be hereditary and at the same time to have disposed him towards the commission of crime (see Table II). The characteristics reported fall into four main groups—physical, intellectual, psychopathic, and moral. The physical conditions include principally such illnesses or constitutional states as are indicated by the occurrence of epilepsy, tuberculosis, rheumatism, chorea, hyperthyroidism, and syphilis—the last not being inherited in the strict biological sense; points of this kind were noted in a moderately high proportion, namely, 53 times among the relatives of 100 delinquents. The intellectual conditions include mental deficiency, inborn dullness, and extreme illiteracy or scholastic backwardness where it seems assignable to a congenital cause; these intellectual weaknesses were observed rather less frequently than the physical—namely, 35 times per 100 families. A third group consists of temperamental conditions marked by pathological



TABLE II.—HEREDITARY CONDITIONS<sup>1</sup>

	DELINQUENT					NON-DELINQUENT			
	Boys		Girls		Aver.	Boys	Girls	Aver.	
	Major Factor	Minor Factor	Major Factor	Minor Factor	—	—	—	—	
<i>I. Physical:</i>									
Tuberculosis....	<i>f.</i>	—	3.3	—	5.4	4.1	2.5	5.0	3.7
	<i>m.</i>	—	4.1	—	2.7	3.5	4.0	3.0	3.5
	<i>r.</i>	—	10.6	—	16.2	12.7	13.0	10.0	11.5
Rheumatism....	<i>f.</i>	—	3.3	—	4.1	3.5	1.5	0.5	1.0
	<i>m.</i>	0.8	7.3	1.4	5.4	8.1	—	1.5	0.7
	<i>r.</i>	—	9.8	—	2.7	7.1	8.0	10.5	9.2
Syphilis.....	<i>f.</i>	—	1.6	—	—	1.0	—	—	—
	<i>m.</i>	—	0.8	1.4	2.7	2.0	—	—	—
	<i>r.</i>	—	4.9	—	6.8	5.6	0.5	—	0.2
Epilepsy.....	<i>f.</i>	1.6	—	—	—	1.0	—	1.2	0.6
	<i>m.</i>	—	0.8	—	—	0.5	—	—	—
	<i>r.</i>	—	2.4	—	1.4	2.0	—	1.5	0.7
Chorea.....	<i>f.</i>	—	—	—	—	—	—	—	—
	<i>m.</i>	—	—	—	—	—	1.0	—	0.5
	<i>r.</i>	—	—	—	2.7	1.0	—	—	—
Hyperthyroidism	<i>f.</i>	—	—	—	—	—	—	—	—
	<i>m.</i>	—	—	1.4	—	0.5	—	—	—
	<i>r.</i>	—	—	—	1.4	0.5	—	—	—
Total.....		2.4	48.9	4.2	51.5	53.1	30.5	33.2	31.8
<i>II. Intellectual:</i>									
Mental deficiency	<i>f.</i>	—	—	—	—	—	—	—	—
	<i>m.</i>	1.6	—	—	—	1.0	—	—	—
	<i>r.</i>	—	3.3	—	4.1	3.5	1.0	—	0.5
Dullness <sup>2</sup> .....	<i>f.</i>	1.6	3.3	—	2.7	4.1	—	—	—
	<i>m.</i>	0.8	5.7	1.4	2.7	5.6	1.5	2.5	2.0
	<i>r.</i>	—	8.1	—	8.1	8.1	2.0	3.5	2.7
Illiteracy <sup>3</sup> or	<i>f.</i>	—	1.6	—	1.6	1.6	—	—	—
backwardness...	<i>m.</i>	—	5.7	—	4.1	5.1	1.5	—	0.7
	<i>r.</i>	—	6.5	—	6.8	6.6	2.5	2.0	2.2
Total.....		4.0	34.2	1.4	30.1	35.6	8.5	8.0	8.2

<sup>1</sup> *f* indicates that the condition was reported of the child's father, *m* of the child's mother, *r* among others of his nearer relatives.

<sup>2</sup> Presumably congenital: mental age apparently below 12.0 when adult.

<sup>3</sup> Reading and writing apparently below Standard V when adult.

symptoms: under this head are included certifiable insanity, temperamental deficiency, and various emotional disturbances involving minor neuropathic or psychopathic symptoms; such conditions occurred somewhat more frequently, namely, 42 times per 100 families. A fourth and final group was made of temperamental conditions marked by moral symptoms: under this head were placed suicide, alcoholism, sexual irregularities, vio-

TABLE II.—HEREDITARY CONDITIONS—Continued

	DELINQUENT					NON-DELINQUENT		
	Boys		Girls		Aver.	Boys	Girls	Aver.
	Major Factor	Minor Factor	Major Factor	Minor Factor	—	—	—	—
<i>III. Temperamental (Pathological Symptoms):</i>								
Insanity . . . . . <i>f.</i>	—	—	2.7	1.4	1.5	1.5	—	0.7
<i>m.</i>	1.6	—	—	—	1.0	—	—	—
<i>r.</i>	—	5.7	—	8.1	6.6	3.5	2.5	3.0
Minor neuropathic <i>f.</i>	1.6	4.9	1.4	1.4	5.1	1.0	3.5	2.2
or psychopathic <i>m.</i>	2.4	5.7	4.1	2.7	7.6	5.5	2.0	3.7
symptoms <i>r.</i>	—	3.3	—	6.8	4.6	6.0	4.0	5.0
Temperamental <i>f.</i>	3.3	0.8	4.1	1.4	4.6	1.5	—	0.7
deficiency . . . . . <i>m.</i>	2.4	1.6	2.7	4.1	5.1	2.0	1.0	1.5
<i>r.</i>	—	4.1	—	9.5	6.1	3.0	2.5	2.7
Total . . . . .	11.3	26.1	15.0	35.4	42.2	24.0	15.5	19.7
<i>IV. Temperamental (Moral Symptoms):</i>								
Sexual irregular- <i>f.</i>	—	3.3	2.7	4.1	4.6	2.0	—	1.0
ity . . . . . <i>m.</i>	0.8	13.0	4.1	21.6	18.2	5.0	3.5	4.2
<i>r.</i>	—	2.4	—	16.2	7.5	2.5	6.0	4.2
Violent temper; <i>f.</i>	1.6	9.0	1.4	6.8	9.6	1.5	—	0.7
cruelty . . . . . <i>m.</i>	—	3.3	1.4	4.1	4.1	0.5	1.0	0.7
<i>r.</i>	—	6.5	—	4.1	5.6	—	—	—
Acquisitiveness <sup>4</sup> <i>f.</i>	2.4	3.3	—	2.7	4.6	—	2.0	1.0
<i>m.</i>	—	0.8	—	4.1	2.0	—	—	—
<i>r.</i>	—	11.4	—	9.5	10.6	3.5	1.5	2.5
Wandering <sup>5</sup> . . . . <i>f.</i>	2.4	3.3	1.4	2.7	5.1	—	2.0	1.0
<i>m.</i>	1.6	0.8	1.4	—	2.0	—	—	—
<i>r.</i>	—	13.8	—	8.1	11.7	—	1.5	0.7
Suicide . . . . . <i>f.</i>	—	2.4	—	4.1	3.0	—	—	—
<i>m.</i>	—	—	—	1.4	0.5	—	—	—
<i>r.</i>	—	0.8	—	2.7	1.5	1.0	—	0.5
Idleness (extreme) <i>f.</i>	—	5.7	—	2.7	4.6	1.5	3.0	2.2
<i>m.</i>	—	1.6	—	4.1	2.5	—	—	—
<i>r.</i>	—	8.1	—	14.9	10.6	1.0	5.5	3.2
Alcoholism . . . . <i>f.</i>	—	12.2	—	16.2	13.7	4.5	7.0	5.7
<i>m.</i>	—	7.3	—	20.3	12.2	4.0	2.5	3.2
<i>r.</i>	—	8.1	—	17.6	11.7	5.5	6.0	5.7
Total . . . . .	8.8	117.1	12.4	168.0	145.9	32.5	41.5	37.0

<sup>4</sup> Chiefly theft.

<sup>5</sup> Migration (gipsies, tramps) and emigration among adults. Truancy and wandering among children.

lent temper and cruelty (sometimes amounting to definite assault), convictions for theft, wandering (migration and emigration among adults, of whom many were gipsies, tramps, or vaga-

bonds, and, among children, truancy and running away), and extreme idleness such as might be supposed to be the outcome of some innate constitutional lethargy; facts of this nature were reported as many as 146 times among the members of one hundred families.

These, therefore, were the main inheritable conditions occurring among the relatives of juvenile delinquents. It will be noted that not all the inheritable conditions are criminal qualities, but qualities apparently criminal bulk larger than the rest. Indeed, what I have termed temperamental disturbances with moral symptoms not only recur far more frequently than any other one group—physical, intellectual, or psychopathological; they recur more frequently than all the rest put together.

From the percentage which I have just given for moral abnormalities in relatives—a figure amounting to nearly 150 per cent—it might be inferred that on an average each delinquent child has between one and two relatives guilty of some immoral lapse. Such a statement, though true, may be misleading. Of the recorded transgressions the commonest—drunkenness, suicide, minor sexual offenses, and minor outbreaks of temper—can hardly be classed as typical crimes, and, whether venial or grave, the larger portion of them tends to be concentrated within a few outstanding families, often small and self-contained. If we count up, not the number of recorded offenses, but only the number of families showing such records, then the proportion of delinquent children with a family history of immorality proves to be 54 per cent (Table III). Among these, however, the lapse reported was in nearly two-thirds of the cases too trifling to amount to a breach of the law. Within the whole group of delinquents studied there were only 11 per cent whose relatives had been sentenced for crime; and only 19 per cent whose relatives, whether sentenced or not, were known to have committed some gross offense. As many as four-fifths of the children could plead no history among their kindred of any definable crime.<sup>31</sup>

---

<sup>31</sup> It is but just to add that the statistics on this point differ enormously in different investigations (for references see my original report of this inquiry, *Brit. Journ. Med. Psych.*, II, 1923, p. 14). Some investigators

TABLE III.—RELATION BETWEEN JUVENILE DELINQUENCY AND CONDITIONS OBSERVED

	Percentage of Cases		Frequency Ratio	Coefficient of Association
	Delinquent	Non-Delinquent		
<i>I. Hereditary Conditions:</i>				
A. Physical.....	36.9	22.7	1.63	.17
B. Intellectual.....	25.4	7.7	3.30	.34
C. Temperamental (with pathological symptoms).....	24.4	10.7	2.28	.24
D. Temperamental (with moral symptoms).....	54.3	17.5	3.10	.41
Average.....	—	—	2.58	.29
<i>II. Environmental Conditions:</i>				
A. Within the Home—				
1. Poverty.....	52.8	38.2	1.38	.15
2. Defective family relationships.....	57.9	25.7	2.25	.33
3. Defective discipline.....	60.9	11.5	5.30	.55
4. Vicious home.....	25.9	6.2	4.18	.39
B. Outside the Home.....	45.2	20.2	2.24	.29
Average.....	—	—	3.07	.34
<i>III. Physical Conditions:</i>				
A. Developmental.....	21.3	5.5	3.87	.37
B. Pathological.....	69.0	54.7	1.26	.15
Average.....	—	—	2.56	.26
<i>IV. Psychological Conditions:</i>				
A. Intellectual.....	68.5 <sup>1</sup>	27.5 <sup>1</sup>	2.47	.41
B. Emotional:				
1. Inborn:				
(a) Specific instincts	59.4	12.0	4.95	.53
(b) General emotionality.....	48.2	11.7	4.12	.46
2. Acquired:				
(a) Interests, etc.....	45.7	13.2	3.46	.40
(b) Complexes, etc....	64.5	20.5	3.15	.45
Average.....	—	—	3.63	.45

<sup>1</sup> Cases of supernormal ability not included.

*Coefficients of Association*

Such then are the figures for inheritable defects, or rather for defects reputed to be inheritable in delinquent families. But before we know what weight attaches to these raw percentages, we must turn to a normal sample and ask how often the same conditions are to be found in the population at large. Table II shows for non-delinquents as well as for delinquents the number of times each condition was observed, whether in the same or in different families; Table III shows the number of separate families showing one or more of such conditions. Among the relatives of delinquents moral defects are the most frequent, but they are also the most frequent among the relatives of non-delinquents (Table II). And again, while among the delinquents there is little difference in number between the families showing intellectual defects and the families showing temperamental defects of a pathological kind, among the non-delinquents the former are much more unusual than the latter (Table III).

Here then is a complicated problem in cross-contrasts. How are such differences to be assessed?

The best way of making these comparisons is to use some algebraic formula and reduce each pair of percentages to one simple index figure. Such a figure will express in a single measurement the amount of similarity between parents and their offspring or, again, the degree of correspondence between offenses in the children and hereditary defects in the families of each one. Index figures of this sort are known to statisticians as coefficients of correlation or association. The coefficient is a fractional number devised to measure on a scale from 0 to 1 the degree to which any two conditions vary or are found together. I have therefore in the last column of Table III given

---

announce that as many as 70 per cent of their juvenile delinquents have been the offspring of fathers or mothers who have themselves been sentenced. Big figures of this order, however, have usually been obtained in criminal institutions, where the inmates, as a rule, form a highly selected group. They are often habitual offenders of the most difficult types; and the fact that one or other parent has been, or is still, in jail often forms the decisive reason for committing the child to such a place. The figures of the most careful inquirers, analyzing samples more truly representative, generally range between 10 and 25 per cent.



coefficients of association for each group of inheritable characters and, to provide some rough standard of comparison, I have added similar coefficients for every type of condition with which I propose to deal in the sequel.<sup>32</sup>

For the sake of the non-mathematical, I have used a second mode of comparison, simpler to compute, less formidable to understand, though not so accurate perhaps in its statistical significance. I have calculated the relative frequency of each condition as observed among the delinquents, taking its frequency among the non-delinquents throughout to be unity. This second index figure, which may be termed a "frequency ratio," is obtained by merely dividing the first percentage by the second (compare Table III, first three columns). It will be seen that, although the percentages for intellectual and temperamental defectives<sup>33</sup> are among the delinquent families almost the same, the frequency ratios differ greatly. The former occur more than three times as often among delinquents as among non-delinquents; the latter, only twice: thus, temperamental defects, though almost as numerous absolutely, are, relatively speaking, far less common in the delinquent families than intellectual defects. The frequency ratio for moral defects is almost as high as for intellectual. In this last instance, however, the association coefficient gives the truer index: for the simple ratio of the two frequencies gives insufficient weight to the high proportion of moral defects common to the two groups. For moral defects

---

<sup>32</sup>For the formula employed and for its usefulness in psychological inquiries like the present, I may refer the reader to the appendix in my work on *Mental and Scholastic Tests* (pp. 217-20). The probable error of the majority of the coefficients is in the neighborhood of  $\pm .04$ . The association coefficients given in my previous article (*loc. cit. sup.*, p. 10) are average coefficients based on the several conditions taken singly.

It cannot be too strongly emphasized that in dealing with the intangible qualities of human nature and society, these statistical measurements have nothing of the precision which they could claim if we had been weighing coal or chemicals instead of the mind of the erratic child. They are simply compendious ways of summarizing our rough data and nothing more.

<sup>33</sup>In this paragraph the word "defect" is employed in no technical sense. The phrase "temperamental defective," for instance, is simply used as a convenient abbreviation for "persons showing inheritable temperamental conditions with pathological symptoms."

the association coefficient rises to .41—the largest coefficient of the four.<sup>34</sup> Nevertheless this high figure, it must be remembered, is based upon comparatively minor lapses from morality, not upon sustained and serious habits of crime. Most of the faults of the parents and of the remoter relatives are intermittent outbursts of instinct or emotion; not half of them could be construed as flagrant breaches of the law.

It will be seen, then, that the number of criminal children who might be said to have criminal blood in their veins is, after all, comparatively trifling. To cite conspicuous case histories, and to give selected family trees with crime recurrent in nearly every member of the stock, affords no proof that criminality, as such, is always an inherited tendency. The lawless breed is the rarity, not the rule. The case of sporadic crime is far more usual than the case with a criminal lineage.

Even within the few families where nearly every member is a malefactor, what reason is there to believe that the legacy of vice must have been truly hereditary? Certainly, from the table it might appear that among the delinquent families intellectual or moral defects have nearly twice the relative frequency and apparently twice the influence, of defects in sanity or physique. But the figures for the two former characteristics show a suspicious approach to the figures appended lower down for defective discipline and vicious home surroundings. The suggestion is plain: the child, after all, may be suffering quite

---

<sup>34</sup> The figures here given may be compared with those obtained by Goring from the records of about 1,500 adult convicts (*The English Convict*, 1913, pp. 353 *et seq.*). Goring's method of analysis, as his extensive data warranted, is more elaborate and exact. On the other hand, he had no control group, and, doubting the prisoners' information about their parents, he included serious convictions alone. He concludes that "parents legally designated criminal tend to beget sons who qualify for the same designation; and the intensity of this relationship lies between .4 and .7. . . . On the whole the intensity of resemblance is slightly greater between fathers and sons than between mothers and sons. . . . Thus, although criminals are less than half as fertile as the general population, a thousand criminals beget as many criminals as do five thousand non-criminals." He finds the degree of the apparent inheritance far more marked for such crimes as stealing, violence, damage, and sexual misdemeanor than for such crimes as fraud (*loc. cit.*, pp. 353, 354, 359).

as much from the vice or the bad management brought into the home by a dull or an immoral parent, as from any dullness or immorality that he himself might have inherited.<sup>35</sup> In point of fact, small evidence as a rule is procurable to demonstrate beyond dispute that the criminal proclivities of the parent have been handed down to the child by true biological transmission. Other causes, less hypothetical in character, more obvious in their mode of operation, may very frequently be traced; and their removal is followed in not a few examples by a reform as immediate as it is complete. Many of these provocative factors—bad companions, bad neighborhoods, bad discipline, and a bad example at home—are a by-product of the moral laxity of the parents themselves, the degeneracy of the family thus operating indirectly through the resulting environment instead of directly by its influence on the germ cells. As in physical disorders, so in moral—contagion is too often mistaken for heredity. The

---

<sup>35</sup> It is noteworthy that in many instances, particularly in those of pathological temperament, the defect is found far more commonly in the delinquent's parents than among his remoter relatives (see Table II). Yet he can have but two parents, while the number of his remoter relatives may be almost infinite. This fact suggests one or both of two conclusions: either that the closer the relationship, the stronger is the influence; or again, that a defect manifested in the parental home is more serious in its operation than a defect carried by the general stock.

In my earlier table (*Brit. Journ. Med. Psych., loc. cit.*, p. 10), I gave separate coefficients (*a*) for each condition as found in the family generally, and (*b*) for the same condition as found in the parents alone, disregarding its possible presence among remoter relatives. The latter, the correlation between defects in children and defects in their parents, is the form of correlation most usually cited and computed in researches on heredity. In my own inquiry, the correlation in this form was always higher. Our present ignorance, however, of the principles of mental inheritance makes it peculiarly dangerous to draw any inferences from a simple association between filial and parental traits. For example it is quite conceivable that intellectual deficiency might, like many negative characteristics, follow the laws of so-called "recessive" qualities and miss alternate generations; while temperamental deficiency, being a positive characteristic due to the excessive strength of the instincts, might obey the laws of so-called "dominant" traits, reappearing generation after generation without apparent intermission. Some evidence—not, it is true, altogether conclusive, yet pointing in this direction—has been brought forward by C. B. Davenport ("Heredity of Constitutional Mental Disorders," *Psychological Bulletin*, XVII, 1920, ix).

only instances where the vices of the child stand in a direct and apparently hereditary relation to the vices of the parent belong (as we shall see more clearly in a subsequent chapter) to specifically limited types—such as sex delinquency (by far the most frequent), wandering, violent temper, and perhaps impulsive theft. Of these every one, we shall find, may be accounted for by a single assumption—by supposing that certain human instincts, which by their very definition are acknowledged to be inherited, may be inherited in differing degrees of natural strength. But even here the instinct is not itself inevitably a criminal one; and, once it is afforded some permissible outlet—through marriage, congenial work, or wholesome recreation—its energies can be diverted from illicit adventures and directed into safe and legitimate paths.

### Conclusion

Crime in itself, therefore, is not inherited. The hereditary constitution of the criminal, such as it is, we can regard as having at most but an indirect effect. The family temperament, first manifested in the lawlessness of his parent, is not at bottom an essentially criminal nature, transmitted as such, but a vague and more general endowment, analogous rather to the congenital enfeeblement that may affect temperament, intelligence, or physique as a whole—extreme degrees of common weaknesses to which in a restricted measure we are all more or less susceptible. Such weaknesses when excessive may favor a moral lapse in later life; they in no way constitute a fatal and inexorable propulsion towards it.

### Treatment

If there is no such thing as a born criminal, there can be no need to consider at length what would be the most suitable way to treat him. Generally speaking, where inborn or hereditary defects of any sort are prominent, the outlook is not hopeful. The more powerful the part played by hereditary factors, the less is the likelihood of successful reform. With the treatment of the actual defects themselves I shall deal in later chapters according to their specific nature.

1. *Eugenic Measures*

Were the commission of crime due to some hereditary impulse itself inevitably criminal, it is clear that little or nothing could be done to reclaim the heir to such a bequest. This cheerless corollary to their doctrines Lombroso and his school admit. "Born criminals," says Lombroso, "including hopeless recidivists and the morally insane, should be regarded as incurable; all of them should be confined for life in a criminal asylum, or relegated to a penal colony, or else condemned to death."<sup>36</sup>

This wholesale policy is a little reminiscent of the advice given by the legate in the French crusade: "*Tuez-les tous: Dieu reconnaîtra les siens.*"<sup>37</sup> At their best such measures would still be purely negative. They would of necessity be based primarily upon eugenic principles—to segregate or sterilize all who openly manifest, or carry in latent form, the seeds of a criminal disposition, until at last the breed becomes extinct. At present the plan is avowedly impracticable. Before any such methods could be advocated or applied, it would be needful first of all, not only to prove that criminality is inherited and the criminal a species by himself, but also to discover what are the laws that govern the inheritance of such a disposition, and what are the signs and symptoms by which its presence might be recognized beyond the chance of a mistake. Such proofs and such discoveries have never yet been made.

If, however, my main contention is correct, the problem of heredity becomes far too complex for any one panacea. What has to be faced is, as we have seen, no single and simple disposition to crime, inherited as such, but numerous underlying weaknesses of all degrees of gravity. With some of these weaknesses, especially the more extreme, we may, it is true, per-

---

<sup>36</sup> *Tropo Presto* (1888), a criticism of what was at that time the New Penal Code of Italy. For a fuller account of the methods proposed by this school, including methods, often admirable, for treating offenders who are not born criminals, see Ferrero, *loc. cit. sup.*, pp. 153-218, and references.

<sup>37</sup> "Kill them all: God will recognize His own."—Arnauld Amalric, at the sacking of Béziers, A.D. 1209 (P. C. d'Heisterbach, *Dialogi Miraculorum Distinctio*, V, xxi, p. 139, ed. B. Tissier).



missibly deal through the control of human breeding. The provisions contained in the Mental Deficiency Act, for example, already allow us, in effect, to segregate the mentally defective during the period of procreation. But the fact that the relation between the primary dispositions and the secondary delinquencies is indirect, variable, and of differing intensity, complicates the general problem almost infinitely.

There is a further limitation. What is hereditary is necessarily inborn, but what is inborn is not necessarily inherited. A mental abnormality is not limited to the families through which it runs; it may appear sporadically, with no known antecedents. Hence, could we dispose of hereditary criminals or defectives by eugenic means, even so we should not have rid ourselves once and for all of the congenital predisposition to crime. The freaks, the sport, the mutation, would still be on our hands. And here the difficulty of diagnosis is enormously increased. As a rule, when there is no direct evidence from the family history that a weakness is inherited, the main proof of an innate factor must proceed mainly by successive elimination of all possible post-natal influences. We have to investigate one by one all the other conceivable factors, environmental, social, physical, and psychological; and show that these are not enough to explain the known manifestations. To deduce from the intrinsic nature of a given defect how far it is inborn will, in the present state of knowledge, be usually too precarious.

## 2. Segregation

The wisdom of segregation, however, by no means depends upon eugenic principles alone. Where hereditary factors are influential, segregation may be advisable in the interests, not only of future generations, but also of contemporary society and of the criminal himself. However strong the inherited predisposition may be, it is usually possible by removing the delinquent from all ordinary opportunities for crime, to reduce his offenses to a minimum. As experience has repeatedly shown, one who has been declared a true case of the born criminal may be entirely free from delinquency under the right kind of treatment in the right kind of institution. What

that treatment and that institution should be, must vary, as we shall find when our analysis unfolds, according to the nature of the individual and of his history, his circumstances, and his crime.

## CHAPTER III

### ENVIRONMENTAL CONDITIONS WITHIN THE HOME

*Wer nicht behaglich ist zu Haus  
Rennt immer ins Unheil hinaus.*

F. RÜCKERT.<sup>1</sup>

He who is not comfortable at home will be always running off into mischief.

#### The Assessment of Environmental Factors

In the causation of crime, and of juvenile crime above all, it is external conditions rather than internal that are commonly seized upon by the practical reformer. Criminals, he asserts, are not born but made; and the making of them he assigns to their surroundings. Environment rather than heredity is to his mind the real, responsible factor.

The evidence he offers is never wholly convincing. It is more from a pious wish than a positive proof that the strength of his assurance springs. Were outer circumstance the only cause of human error, to banish wickedness and to right the world would then seem so alluringly simple. The program of reform would be intelligible and easy. To build better houses, to grant better wages, to close the gin palaces, and to clean up the slums—such plausible proposals would be all that was needful. In support of this preconceived faith what little solid argument is cited proves usually to be negative in nature. When the social conditions of the criminal—his poverty-stricken existence, his insanitary dwelling, his drab and squalid street surroundings—are known to be all so adverse, why make a gratuitous appeal to some unseen and hypothetical influence? Why invoke inheritance or inborn temperament—fatalistic conceptions that can only sap all effort at reform? Are not the admitted and visible ills sufficiently subversive to drive the saintliest to sin?

---

<sup>1</sup> *Unbefriedigung*, I, ii, 35.

To the biologist, on the other hand, heredity is no mere hypothesis but a scientific fact—a verified phenomenon with which he is far better acquainted than he is with the alleys of Euston or the dens by Limehouse docks. Hence, in his zeal to insist upon the universal laws of life, he is apt to overlook its actual conditions. In emphasizing the abstract he underrates the concrete; in proving his theory he forgets what is practical.

Yet the two views are not incompatible; they are complementary. Heredity and environment may each do their sinister share. And an equal attention to either aspect, with an impartial balancing of the respective points in evidence, becomes, however rare and difficult, the first essential to a scientific survey.

In my own attempt to give due credit to each side I lay no claim to have secured conclusive data. To measure the intangible influences that impinge upon the human soul is always a hard and baffling task. Various approaches may be adopted; various methods of comparison may be tried. It is here that recourse to a control group—everywhere, to my mind, indispensable—has proved to be of signal service. Such a device not only enables us to compare the potency of various factors, but also conduces to definiteness where the factors to be compared defy all ordinary measurement. Take such a problem as parental drunkenness, so often charged with fostering crime in the child. Of drunkenness there are innumerable degrees of gravity, and different students will apply the term to very different types of drinker. But wherever we have a normal set of families studied side by side with the delinquent, upon the same lines and by the same investigator, there some index of what is meant by drunkenness is at once afforded: for the investigator's report will state, not only that he found (say) 8 per cent of drunken parents among the delinquent families, but also 3 per cent among the non-delinquent from the same economic class. That figure of 3 per cent, based upon a comparable sample of the average population, explains immediately the special usage of the loose colloquial term even if it be defined no further. And so with other social factors of this vague, equivocal, and qualitative kind.

The environmental factors encountered during my inquiry

TABLE IV.—ENVIRONMENTAL CONDITIONS WITHIN THE HOME

	DELINQUENT					NON-DELINQUENT		
	Boys		Girls		Average	Boys	Girls	Average
	Major Factor	Minor Factor	Major Factor	Minor Factor				
<b>1. Poverty and Concomitants</b>								
Home Circumstances: <sup>1</sup>								
Very poor (A and B)...	1.6	19.5	—	14.9	18.7	21.0	15.0	8.4
Poor (C and D).....	—	35.8	—	37.8	36.5	36.0	38.0	22.3
Comfortable (E and F)	—	[39.9]	—	[44.6]	[41.7]	[39.5]	[44.5]	[51.5]
Well-to-do (G and H)...	—	[3.3]	—	[2.7]	[3.0]	[3.5]	[2.5]	[17.8]
Overcrowding <sup>2</sup> .....	—	18.7	—	24.3	20.7	15.0	16.5	15.7
Absence of all facilities for recreation.....	1.6	10.6	—	5.4	9.6	8.5	6.5	7.5
Total.....	3.2	84.6	—	82.4	85.5	80.5	76.0	53.9
<b>2. Defective Family Relationships:</b>								
Father dead.....	1.6	9.0	1.4	13.5	12.2	13.5	11.5	12.5
Deserted, separated, or divorced.....	—	6.5	2.7	10.8	9.1	0.5	—	0.2
Absent <sup>3</sup> .....	3.3	15.4	—	12.2	16.2	8.5	7.0	7.7
Mother dead.....	0.8	9.8	4.1	14.9	13.7	3.5	4.5	4.0
Deserted, separated, or divorced.....	—	5.7	1.4	6.8	6.6	—	—	—
Both mother and father dead or deserted.....	—	[1.6]	[1.4]	[5.4]	[3.5]	[0.5]	[1.0]	[0.7]
Prolonged absence from parents:								
With friends or rela- tives.....	—	10.6	—	17.6	13.2	1.0	0.5	0.7
At institutions.....	—	13.0	—	18.9	15.2	0.5	—	0.2
Step- (or foster) father..	—	7.3	—	14.9	10.1	5.5	4.5	5.0
Step- (or foster) mother..	—	12.2	2.7	17.6	15.2	2.0	2.5	2.2
Illegitimate <sup>4</sup> .....	—	6.5	—	9.5	7.6	0.5	1.0	0.7
Only child.....	—	15.4	—	6.8	12.2	2.5	1.0	1.7
Total.....	5.7	111.4	12.3	143.5	131.3	38.0	32.5	35.2

<sup>1</sup> For classification used see p. 65.

<sup>2</sup> For definition see p. 84.

<sup>3</sup> Chiefly, absent for a long period upon military service; in some instances, recently returned. Also includes such cases as an illegitimate child whose father is not living with the mother.

<sup>4</sup> Includes also the few cases born out of wedlock where the mother and father afterwards married, or lived together as married. Among the non-delinquent the number of children acknowledged as illegitimate seems at first sight rather low: 4 per cent of the births in London are illegitimate; but a number of these are subsequently boarded out elsewhere; and during the first six months of life the death-rate is nearly three times as high as among the legitimate.

have all been systematically observed and defined in this way. They divide themselves at the outset into two broad categories: first, conditions obtaining within the home, and, secondly, conditions obtaining outside it, whether in the school, the street, or the young delinquent's place of business. And the former group, home conditions, seem in their turn to fall under four distinct headings, narrower and more specific, relating respectively to the material, the conjugal, the disciplinary, and the



TABLE IV.—ENVIRONMENTAL CONDITIONS WITHIN THE HOME—Continued

	DELINQUENT					NON-DELINQUENT		
	Boys		Girls		Average	Boys	Girls	Average
	Major Factor	Minor Factor	Major Factor	Minor Factor				
<b>3. Defective Discipline:</b>								
Indifference (no attempt at discipline) {	f.	—	3.3	—	1.4	2.5	—	—
Weak discipline (due to moral or intellectual weakness) {	f.	0.8	6.5	—	4.1	6.1	0.5	—
	m.	—	9.0	—	4.1	7.1	1.0	—
	f.	—	—	—	—	—	—	—
	m.	2.4	24.4	1.4	16.2	23.4	3.5	2.0
	g.	—	—	2.7	1.4	1.5	—	—
Weak discipline (due to physical weakness) {	f.	—	2.4	—	1.4	2.0	—	0.5
	m.	3.3	6.5	1.4	5.4	5.4	1.0	3.0
	g.	—	1.6	—	1.4	1.5	—	—
Weak discipline (due to absence of parent at work) {	f. <sup>5</sup>	—	2.4	—	4.1	3.0	—	—
	m.	0.8	7.3	—	2.7	6.1	3.0	0.5
	r.	—	—	—	2.7	1.0	—	—
Over-strict discipline {	f.	1.6	13.0	—	1.4	9.6	2.5	3.0
	m.	—	1.6	2.7	2.7	3.0	0.5	2.0
	r.	—	—	—	2.7	1.0	—	—
Disagreement about control of child.....	—	—	4.9	—	2.7	4.1	—	—
Total.....	—	8.9	82.9	8.2	51.7	79.5	12.0	11.0
<b>4. Vicious Home:</b>								
Sexual immorality at home <sup>6</sup> .....	—	—	2.4	1.4	6.8	4.6	—	0.5
Molestation <sup>7</sup> .....	—	—	—	—	2.7	1.0	—	—
Irregular unions <sup>8</sup> .....	—	—	4.1	—	9.5	6.1	0.5	1.0
Drunkenness <sup>9</sup> .....	—	—	6.5	—	10.8	8.1	2.5	3.5
Quarreling.....	—	—	5.7	—	8.1	6.6	1.0	0.5
Ill-treatment..... {	f.	—	2.4	—	5.4	3.5	3.5	—
	m.	0.8	—	1.4	2.7	2.0	—	1.5
	g.	—	1.6	1.4	4.1	3.0	—	—
Neglect.....	—	—	4.1	—	5.4	4.6	5.0	2.5
Criminal encouragement	0.8	0.8	0.8	1.4	—	1.5	—	—
Bad companionship (within the home).....	—	—	3.3	1.4	2.7	3.5	—	—
Vicious conduct (not included above) <sup>10</sup> .....	—	—	6.5	—	8.1	7.0	0.5	—
Total.....	—	1.6	37.4	7.0	66.3	51.5	10.0	9.5

<sup>5</sup> There being no mother.

<sup>6</sup> Not included under preceding or following headings.

<sup>7</sup> Sexual; by relatives in the home.

<sup>8</sup> Chiefly parents (or foster parents) living together unmarried.

<sup>9</sup> <sup>10</sup> In this table only present or recent misconduct in the child's own home is included; the figures given under "hereditary conditions" include also offenses committed in the remote past or away from the child's own home.

<sup>10</sup> Chiefly stealing or habitual gambling and betting.

moral status of the household. The particular points observed, together with the frequency of each one, are enumerated in detail in Table IV.<sup>2</sup>

<sup>2</sup> In this, as in all similar tables, I have endeavored to separate principal or major factors from accessory or minor. The basis of this distinction and its ultimate bearing upon the general conclusions to be drawn will appear more clearly in our final review (see Chapter XIV).

Domestic  
factors 64

1. Poverty

*Definition*

Of the conditions obtaining within the delinquent's home the first and most obvious are the material. How far is poverty—economic stress, with all its various concomitants—productive of juvenile crime? Many writers upon social reform have proclaimed that the root of human evil is the want of money. But money may be wanting in different degrees. Once more the need for definition is plain. What is meant by being poor?

Poverty may be most conveniently defined to mean earnings insufficient for the maintenance of bodily health. By taking the expenditure needed for food, rent, clothing, and fuel, with a family of a stated size, it is possible to calculate for any given year a minimum standard for the cost of living. This minimum standard may be termed the poverty line; it marks the margin of a bare subsistence.<sup>3</sup> I find in my delinquent-cases that where full particulars were obtainable, 16 per cent fell defi-

---

<sup>3</sup> The method adopted is that of Mr. Seebohm Rowntree (*Poverty*, 1901, Chap. iv, "The Poverty Line")—a method applied to a similar purpose by the Juvenile Organizations Committee of the Board of Education in its *Report on Juvenile Delinquency* (1920, p. 10). A "new standard," based on the same conception slightly modified in detail, has been suggested by Bowley and Burnett-Hurst (*Livelihood and Poverty*, 1915, p. 37), and leads to no very discrepant result.

I should add that in assessing poverty in individual cases it is not sufficient to take, what is so often the sole statement given by the case-sheet, merely the earnings of the father nor even, though it provides a far better index, the ratio of the total income (after rent has been deducted) to the size of family (children being counted as fractions). The comfort of a home is not to be valued by the wages of the man at the head of it. The total earned may be ample, or more than ample, for all the fundamental needs of the household; but the wasteful or thriftless mode in which it is squandered may yet leave the children on the brink of destitution. The wise inquirer, therefore, asks the mother, not merely "How much does your husband earn?" but also, "How much does he allow you for housekeeping?" And he estimates the status of the home, not merely in numerical figures, but quite as much by its visible cleanliness and tidiness and by the way the inmates are fed, clothed, and shod. To deduce, as is sometimes done, the connection between poverty and crime simply from the monetary contributions ordered towards the maintenance of children at industrial schools—figures taken directly from official tables—is to court very dubious conclusions.

nely below this line of poverty,<sup>4</sup> one child in six was thus in want of the common necessities of life. Of these necessitous offenders by far the majority had been reported for theft. In households below the poverty line as many as 81 per cent of the offenses belonged to this category; in households above the poverty line, only 63 per cent.

In classifying these and the remainder of my cases I have adopted the broad economic categories suggested by Charles Booth in his study of *Life and Labour in London*.<sup>5</sup> The entire population he divides into eight social classes or strata as follows:

A. *Very poor*. Occasional laborers; loafers; street-sellers; the destitute, the criminal, and the semi-criminal. (Among my delinquent cases, 7.3 per cent of the boys, and 5.4 per cent of the girls were from homes of this type.)

B. *Very poor*. Irregular earnings; casual labor. (This class and the preceding approximately include all those below the poverty line as just laid down, and live in "primary poverty.")

C. *Poor*. Intermittent earnings; seasonal labor.

D. *Poor*. Small, but constant earnings; unskilled, but regular labor. (Most of this class and all of the preceding may be described as living in "secondary poverty": their earnings do not suffice to maintain a constant level of physical health, because, though theoretically above the minimal standard for necessities, much of it is absorbed by other expenditure, useful, needless, or unintelligent.)

E. *Comfortable*. Regular standard earnings: artisans, small shopkeepers (with no assistants).

F. *Comfortable*. High class labor, well paid: foremen, best-paid artisans.

G. *Well-to-do*. Lower middle-class: larger shopkeepers, tradesmen, small employers, clerks.

H. *Well-to-do*. Upper middle and upper classes: servant-keeping families and professional men.

Of my delinquent children, 19 per cent—one in five—come from classes A and B, that is, from homes that were "very

<sup>4</sup> The figure is somewhat smaller than that of the *Report* just cited—24.2 per cent (p. 11).

<sup>5</sup> *Op. cit.*, Vol. I (1889), pp. 33 *et seq.* A somewhat similar classification has been used by Mr. Rowntree, who virtually combines into single classes each successive pair except the first (*Poverty*, pp. 53 and 57). The distinction between "primary" and "secondary" poverty is his.

poor" in the sense above defined. Of the general population of London<sup>6</sup> only 8 per cent, less than half the former figure come from such homes. Thirty-seven per cent of the delinquents come from the next two classes (C and D)—"moderately poor"; and of the general population, 22 per cent. The biggest of my batches, 42 per cent, come from classes E and F—those designated by Booth as "comfortable."<sup>7</sup>

*Thus over one-half of the total amount of juvenile delinquency is found in homes that are poor or very poor,*<sup>8</sup> and the figures

<sup>6</sup> Here the figures from my control group cannot be used as a basis for comparison. The non-delinquent children, it will be recalled, were intentionally selected as belonging to the same social classes as the delinquent—one or two non-delinquents (where possible, from the same school and street) being paired off, as it were, against each delinquent. Hence, the proportions falling into the different economic grades are almost identical for the two parallel series. I have here, therefore, taken Charles Booth's estimates instead (*op. cit.*, Vol. II, 1891, p. 21).

In Table IV the figures for "home circumstances" given under the heading of "average" have also been taken from Booth (*loc. cit.*); the figures given under the headings of "boys" and "girls" are those actually observed in the present inquiry. Note that figures in brackets are not included in the totals at the foot of the column.

<sup>7</sup> This figure will probably surprise those familiar with none but the industrial school type. The explanation is clear. In the better kind of home, the parents and interested friends more often desire—and more successfully attempt—to debar their children's petty misdemeanors from becoming a subject of official inquiry and action; the official agency in its turn, when apprised of all the facts, is more reluctant to banish a child from a good home to an industrial school.

It is, I may add, my general experience that in well-to-do homes (and, I fancy, in comfortable homes—though the present figures hardly bear this out) delinquent girls are fewer in proportion to their total number than delinquent boys.

<sup>8</sup> English readers are astonished to find how small an emphasis is placed upon poverty by Healy. In only 0.5 per cent of his Chicago cases was poverty a major cause, and in only 7.2 a minor one (*op. cit.*, p. 134); in a volume of over eight hundred pages the short paragraph devoted to poverty occupies no more than seventeen lines. On the other hand, Breckinridge and Abbott in their excellent investigation of the home conditions of court cases in the same city allege that "in round numbers nine-tenths of the delinquent girls and three-fourths of the delinquent boys come from the homes of the poor"—a term which, as they explain, roughly includes the four lowest grades in Charles Booth's classification (*The Delinquent Child and the Home*, 1912, p. 74). Morrison's often-quoted figures for English children are equally high. "In all but 15 per cent," he writes, "the parents were unable to pay even two shillings

show very trenchantly, were figures needed for the purpose, that poverty makes an added spur to dishonesty and wrong.

Yet our attention will not be confined to the poorer classes alone. Since of the total inhabitants of London no more than 30 per cent belong to the lowest social strata (classes A, B, C, and D), the amount of delinquency coming from those lowest social strata is beyond question disproportionate; nevertheless, in the higher and more prosperous ranks its frequency is still unexpectedly large. And when nearly half the offenders come from homes that are far from destitute, poverty can hardly be the sole or the most influential cause.

#### *Local Distribution of Juvenile Delinquency*

The broad association between crime in the young and poverty in the home and its surroundings is at once impressed upon the eye if a chart be made of the distribution of juvenile delinquency in the different parts of London. With this aim in view I have secured the address of every boy or girl reported as an industrial school case during the last two years, namely, 1922 and 1923; and have calculated for each electoral area in the county, what is the ratio of reported cases of the total number of children on the rolls of the Council's schools.<sup>9</sup> The

---

a week towards maintenance" (*Juvenile Offenders*, 1900, p. 176). But, as I have just remarked, percentages of this nature, based solely on cases actually committed by a court, tend to exaggerate the frequency of poverty among juvenile delinquents generally.

<sup>9</sup>In making this special inquiry I have eliminated cases of mere destitution or non-attendance at school (cases reported by the attendance officer or the industrial school officer and those dealt with under the Elementary Education Act, 1876), since here the parent or home is at fault rather than the child.

The figures for the separate electoral divisions are not to be too closely pressed. The number of cases reported during a couple of years are naturally small—barely two thousand altogether. My object in studying two consecutive years was to obtain some measure for the constancy of the percentages. The reliability coefficient for each year—the correlation, that is, of one year with the next—proves to be .83. Hence the sample selected is sufficiently trustworthy for a preliminary analysis. It would, however, be of great value if some investigator could collect detailed figures over a far longer period of time and analyze them more minutely according to the special characteristics of the several districts and streets. The statistics published during the past in the *Annual*



percentages so obtained have been made the basis of a map of juvenile crime (Fig. 4, p. 70). Such a map may be instructively compared with the map of London poverty published by Charles Booth<sup>10</sup>: the correspondence between the darker areas upon either sheet will be immediately apparent.

The streets where the incidence of childish crime is greatest are located in zones or areas of half a dozen types:

(1) Highest of all are the figures in the three small boroughs adjacent to the City on its northern edge—Holborn, Finsbury, and Shoreditch. These districts, after the City itself, are the oldest regions of London. The opprobrious title of "the darkest spot for crime" has usually been applied to Hoxton<sup>11</sup>; but in actual fact it would be a label more fittingly affixed to the eastern portion of Finsbury. In Finsbury the annual percentage of juvenile offenders rises to more than four per thousand. Here are by far the most densely populated parts; here the death rate is all but the highest; and here too is one of the highest of the birth rates. Poverty is not extreme, yet not one family in a hundred is sufficiently well-to-do to pay for the edu-

---

*Reports* of the Council contain figures for the twelve main educational divisions only; but a study of the successive *Reports* shows that among these twelve divisions the relative distribution of juvenile crime is pretty steady from one year to the next. The twelve divisions themselves, however, are too large to yield any picture of the topographical distribution of crime.

In this, as in many other portions of my inquiry, I have been deeply indebted to officers of the Special and Industrial Schools department and of the department for Children's Care, many of whom, in their own spare time, have put their knowledge and experience at my disposal. In the collection and calculation of the data summarized in Table V, I have also received invaluable help from Miss V. G. Pelling, for many years my assistant, and from Miss Marion Blackett, both of whom gave to this inquiry much of their leisure hours.

<sup>10</sup> *Life and Labour in London*, Appendix to Vol. II (1891), "Map of London Poverty by Districts."

<sup>11</sup> "Hoxton is the leading criminal quarter of London, and, indeed, of all England" (Charles Booth, *op. cit.*, Third Series, "London North of the Thames, Inner Ring," Chap. iii, p. 111). "Wall off Hoxton," says another writer, "and you wall off nine-tenths of the criminals in London." The old electoral division of Hoxton is now merged into Shoreditch. On calculating a percentage for juvenile crime in Hoxton alone, I find that the figure, though high, is still below that of Finsbury. It proves to be 0.37 per cent.

cation of its children.<sup>12</sup> Shoreditch follows Finsbury very closely closely in each of these respects. Of my own case coming from this quarter, a large proportion, larger than anywhere else in the country, belongs to families whose only trade is crime—coiners, burglars, housebreakers, and pickpockets. It is a region made familiar even to those who do not know their London by the adventures of *Oliver Twist* and his various villainous companions, and the first impression which the visitor receives is still very much the same as *Oliver's* as he picked his way hither at nightfall with the experienced Mr. Dawkins as his guide: the side streets seem "lined with foul and frowsy dens, where vice is closely packed, and lacks the room to turn—the haunts of hunger and disease, and shabby rags that scarcely hold together."<sup>13</sup>

Those more intimate with this neighborhood—with the purlieus of St. Luke's and the contiguous parishes of Clerkenwell, where Irish, Jews, and Italians mingle with the lowest type of English loafer—will realize how suitably these places lie and how centrally disposed the whole quarter is, as a strategic basis for nefarious designs. The professional criminal likes to fix his headquarters, not in the heart of hard-working penury, but on the edge of the richer haunts of business, pleasure, or residential comfort; at the same time he feels safer with a wide slum district at his rear, where he can lose himself upon occasion, much as Fagin and Bill Sikes retreated into Whitechapel when the hue and cry was raised.

(2) A little farther north there is a second and a broader zone where delinquency is almost as common, though not quite so thickly packed. It is formed by the southern portions of St. Marylebone, of St. Pancras, and of Islington and extends across Haggerston into South Hackney. Of these more scattered districts, though poor back alleys are common enough, many parts are vicious rather than poor; St. Marylebone has one of the highest illegitimate birth rates. But the haunts that appear most criminal, those of St. Marylebone and St. Pancras, are located in the rookeries that have grown up near the termini of the

---

<sup>12</sup> See Table V, pp. 74-5.

<sup>13</sup> Charles Dickens, *Oliver Twist*, Preface, p. viii.

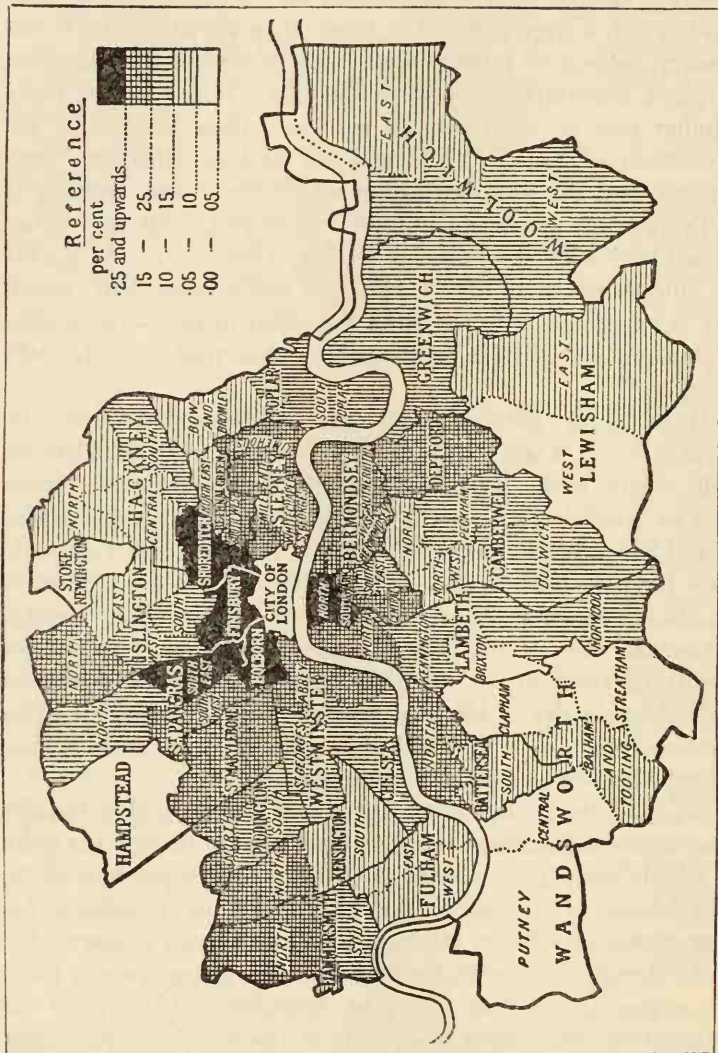

FIG. 4. LOCAL INCIDENCE OF JUVENILE DELINQUENCY IN LONDON

four big railways. Farther north still, directly the line of the Regent's Canal is crossed, moral and material conditions seem to improve together.

(3) Immediately south of the Thames, the long line of slums lying by the northern shores of Battersea, Lambeth, and Southwark, and stretching through Bermondsey, Rotherhithe, and Deptford into the riverside parts of Greenwich and Woolwich, form a region fairly prolific in juvenile offenders. But except in the district immediately south of the city (North Southwark and the parts adjacent), the figures nowhere approach those obtaining on the other side.

(4) To the north of the river a similar slum quarter, very mixed in racial character, is to be found in the nearer parts of the East End—Whitechapel and St. George's, Mile End and Limehouse, and the southwest corner of Bethnal Green. These two broad areas north and south of the river respectively, are alike exceedingly poor—more uniformly poor indeed than any we have mentioned: once more, both the death rate and birth rate are high; the dwellings are overpacked; and there is little open space.

(5) Towards the west the ring round the City is completed by the nearer portion of the West End, namely, the Abbey division of Westminster, the chief amusement district of London. Here again, however, are the resorts of vice rather than of crime, of indulgence more than of indigence: Westminster, indeed, though more salubrious and less congested, shares with Holborn and St. Marylebone the highest proportion of illegitimate births. Around Victoria Station, as around Waterloo Station on the opposite side of the Thames, the streets and alleys are often of a criminal type—resembling those near the big railway termini farther north.

(6) Finally, in the outlying districts to the north of Islington, Paddington, Kensington, and Hammersmith, and (though they are too circumscribed to show upon the map) in those to the south of Tooting, Norwood, and Dulwich, in the low-lying portions of Lewisham and in similar parts of West Woolwich, there are small and isolated patches of crime. In neighborhoods such as these the lawless population is often limited to a few

narrow and notorious side streets that startle the stranger as he picks a crosscut from one main highway to another. It is said that the families that have made such streets a byword were in many instances removed to these regions on the circumference from the central London slums when the large clearances were made at the end of last century. A few groups seem to have sprung up near the big suburban places of amusement, Earl's Court, the White City, and the Crystal Palace, at the time when these exhibitions were first opened or built.

The more reputable regions, comparatively free from juvenile delinquency, are, first, in the center, the City of London itself, and, secondly, on the margin, the residential suburbs, such as Hampstead and Stoke Newington in the extreme north, and in the extreme south the various divisions of Wandsworth and the greater part of Lewisham: these marginal districts, judged by every social index, are well towards the top of the list.

Over a large extent of London, then, the poor districts seem the more criminal. Yet a close acquaintance with the poorest parts themselves will show that the correspondence is anything but absolute: Jonah's formula will not apply. Hence it becomes of interest to gauge the correlation more exactly and to give it some measure of statistical precision.

To this end I have taken, not electoral divisions, but boroughs: for the separate electoral divisions no comparable figures upon social conditions are available. Table V shows the percentages of juvenile delinquency in each of the twenty-nine Metropolitan boroughs, treating for these purposes the City of London as itself an additional borough. Side by side, for every area I have placed such accessible statistics as might be held to reflect light on its social character. These in the main relate to features I have already commented upon in passing—the birth rate, the death rate, the amount of overcrowding, the amount of open space, the proportion of illegitimate children, the proportion of persons in receipt of relief, the percentage of the child population scheduled for purposes of public elementary education, and, finally, the figures for poverty calculated by Charles Booth.<sup>14</sup>

---

<sup>14</sup> The figures for birth rates and death rates relate to the same years



The correlations between the figures for juvenile delinquency and these several statistical assessments are appended in the last line of the table. They are sufficient to show that the connection of childish offenses with poverty and its concomitants is significantly high, though not so high perhaps as previous inquirers, trusting mainly to experience and general impression, have as a rule implied. With the amount of poverty in each borough, as assessed by Charles Booth's survey, the amount of juvenile delinquency is correlated to the extent of .67, with the relative amount of poor relief to the extent of nearly .50; with the number of children scheduled for school purposes (probably the best single index of the present social character of each borough as a whole) to the extent of .63. The highest coeffi-

as the figures for juvenile delinquency, namely, 1922 and 1923. For most of the other items I have had to be content with figures for the last two years for which data are available. The figures for the scheduling of school children are those for the year 1923; in London the scheduling is limited to families residing in houses rated at £28 (pre-war) or less, or in houses which are let in lodgings, or in houses of a higher rating than £28 for which not the head of the family but the landlord is rated, or in quarters patently poorer than these (stables, gardeners' cottages, canal boats, and caravans). The statistics on the several points are all published (or about to be published) in the Council's annual volumes of *London Statistics* for the years in question. Booth's figures (*op. cit.*, Appendix to Vol II, pp. 61-2, *et ante*) were obtained twenty-five years ago; but the recent demolition of slums and the growth of suburban districts have invalidated them less than might be thought. Rough adjustments have sometimes been necessary owing to the fact that the administrative divisions of the county as laid down for special purposes (*e.g.*, poor relief) do not always coincide with the subdivision into boroughs. Booth's percentages are given for areas containing in each about 30,000 inhabitants; but the boundaries were deliberately so drawn that, for larger districts like the Metropolitan boroughs, the figures could be calculated with ease.

Throughout the reader should beware of taking the figures at their face value. The large amount of poor relief in Poplar, the low birth rate in St. Marylebone, the high death rate in the city, the large extent of open space in St. Marylebone and Westminster, the exceptional amount of illegitimacy in Holborn and the City, can hardly offer a fair picture of those areas to any who are unacquainted with the special conditions obtaining both in them and in other districts.

To be accurate, a more concentrated study of the problem would have to take account of many irrelevant factors which disturb the statistics as they stand. This, however, would raise side issues which in a first superficial survey like the present I have no space to pursue.

TABLE V.—LOCAL INCIDENCE OF

Borough	Over-crowding (Percentage of Total Population)	Open Space (Percentage of Area)	Death Rate (Per Thousand)	Birth Rate (Per Thousand)	Illegitimate Births (Percentage of Total Births)
Finsbury.....	34.0	1.9	14.8	24.6	3.9
Holborn.....	19.8	2.2	12.7	14.6	10.0
Shoreditch.....	32.0	1.5	14.7	27.5	4.1
Bermondsey.....	23.2	4.9	14.6	25.9	2.2
St. Pancras.....	22.4	12.4	13.4	21.0	6.8
Southwark.....	23.5	1.1	14.3	24.4	4.6
Stepney.....	29.0	2.3	12.9	23.6	2.5
Battersea.....	12.4	18.7	12.0	20.9	4.4
Deptford.....	12.8	2.0	12.5	22.1	3.2
St. Marylebone....	17.9	23.7	12.9	15.9	10.9
Westminster.....	10.1	27.7	11.8	12.8	11.8
Paddington.....	15.4	7.4	12.4	18.4	8.8
Bethnal Green.....	27.8	13.0	13.3	24.7	2.5
Islington.....	19.4	1.5	12.8	21.8	4.2
Hammersmith.....	13.8	12.1	12.0	20.3	6.6
Lambeth.....	12.7	6.3	12.7	20.5	5.4
Poplar.....	21.2	3.7	12.8	26.1	2.3
Kensington.....	16.7	2.8	13.0	17.6	8.2
Chelsea.....	13.7	0.8	13.0	16.2	9.0
Greenwich.....	13.8	11.1	12.0	20.7	3.7
Camberwell.....	12.8	5.0	12.3	21.2	3.6
Fulham.....	13.1	4.2	11.4	19.8	5.5
Woolwich.....	7.8	5.9	10.8	20.3	4.0
Hackney.....	11.5	18.8	11.7	20.3	3.6
Lewisham.....	4.7	5.1	10.7	18.2	4.9
City of London....	6.6	0.6	12.8	9.6	8.1
Wandsworth.....	6.8	12.6	10.8	16.3	4.7
Hampstead.....	6.5	14.5	11.0	14.5	7.3
Stoke Newington...	8.1	6.4	12.2	18.0	2.8
Average.....	16.2	7.9	12.6	19.9	5.5
Correlations with Juvenile Delin- quency.....	.77	.22	.70	.40	.05

<sup>1</sup> The coefficient in brackets is that obtained by the method of rank differences, which here differs considerably from that obtained by the ordinary product moment method mainly owing to the anomalous percentage shown by the borough of Poplar.

cient of all is that for the correlation between juvenile delinquency and overcrowding, namely, .77. The correlation with the death rate is nearly as high. Allowing for the gross shortcomings, inevitable in estimates so crude, so vague, and in some cases so largely out of date, these several figures are remarkably

## JUVENILE DELINQUENCY IN LONDON

Borough	Juvenile Delinquents (Percentage of Children on School Rolls)	Poverty (Percentage of Inhabitants Living in Poverty)	Children Scheduled for Public Elementary Education (Percentage of Children of Elementary School Age)	Poor Relief (Number per Thousand in Receipt of Domiciliary Relief)
Finsbury . . . . .	0.42	36.7	100.0	21.5
Holborn . . . . .	0.36	48.9	92.4	16.3
Shoreditch . . . . .	0.28	42.4	99.9	51.2
Bermondsey . . . . .	0.23	44.0	99.8	46.1
St. Pancras . . . . .	0.21	30.4	94.2	20.4
Southwark . . . . .	0.18	48.5	99.7	32.2
Stepney . . . . .	0.17	38.3	99.5	19.5
Battersea . . . . .	0.16	38.2	95.3	43.0
Deptford . . . . .	0.16	40.1	98.6	39.4
St. Marylebone . . . . .	0.15	27.4	90.9	7.8
Westminster . . . . .	0.15	35.1	92.2	5.3
Paddington . . . . .	0.14	21.7	90.5	14.8
Bethnal Green . . . . .	0.14	44.6	98.9	24.8
Islington . . . . .	0.14	31.2	95.8	25.6
Hammersmith . . . . .	0.13	33.9	94.8	17.1
Lambeth . . . . .	0.12	26.1	90.5	20.6
Poplar . . . . .	0.12	35.8	98.7	82.6
Kensington . . . . .	0.12	25.1	89.7	9.5
Chelsea . . . . .	0.12	24.5	94.3	12.5
Greenwich . . . . .	0.11	36.8	87.7	16.3
Camberwell . . . . .	0.10	28.9	93.6	33.8
Fulham . . . . .	0.09	24.7	94.9	13.8
Woolwich . . . . .	0.09	24.7	92.3	27.2
Hackney . . . . .	0.08	23.7	94.0	18.3
Lewisham . . . . .	0.07	18.1	84.7	22.7
City of London . . . . .	0.05	31.5	82.5	3.5
Wandsworth . . . . .	0.04	27.4	82.9	8.2
Hampstead . . . . .	0.02	13.5	64.5	2.5
Stoke Newington . . . . .	0.00	18.8	88.9	7.6
Average . . . . .	0.14	31.8	92.5	22.9
Correlations with Juvenile Delinquency . . . . .	—	.67	.63	.28 [.48] <sup>1</sup>

consistent one with another. They indicate plainly that it is in the poor, overcrowded, insanitary households, where families are huge, where the children are dependent solely on the State for their education, and where the parents are largely dependent on charity and relief for their own maintenance, that juvenile delinquency is most rife.

Once more, it must be borne in mind that data collected for a

period of two years only, and that a period still influenced by the effects of the war, can be in no way conclusive. They do, however, at least point out a fruitful problem for further research and a method by which that problem can be profitably attacked. But throughout I must insist that, however extensive and however exact, a mere comparison of tabulated figures must never take the place of concrete studies or of an intensive first-hand scrutiny of the concrete chain of causation, as it operates in particular cases. Here, as elsewhere, in gauging the effect of any natural agency, we can put little faith in armchair deductions: we must watch that agency at work.

### *Illustrative Cases*

When poverty is present, how does it exert its influence? Of the various ways in which economic hardship may promote or encourage crime, the most immediate is through semi-starvation. Hunger is the stimulus, and the ensuing crime is theft—the pilfering either of food itself or of money to buy food, or else of articles to be sold or pawned for such money.

The story that follows will afford, I think, an authentic instance of this motive—the first specimen of its kind that I encountered on taking up my work in London.

Tommy B.<sup>15</sup> had been the subject of repeated accusation by shopkeepers and costermongers near his home. Their complaints, reaching his head master, were corroborated by other pupils, who testified to numerous petty thefts from counters, barrows, and stalls. One evening after school, five shillings

<sup>15</sup> *Age:* 10½. *Home Circumstances:* Extreme poverty (see above).

*Family History:* Father, pulmonary tuberculosis. Paternal grandmother, said to have died of consumption.

*Physical History and Condition:* Pregnancy and birth normal. Weight at birth, 7½ lbs. Rickets, whooping cough, and measles. Exceedingly under-developed and ill-nourished (see above); no active illness.

*Intelligence and School Attainments:* Mental Age, 10.0 (Mental Ratio, 98). Reading, 9.5. Spelling, 9.0. Composition, 8.5. Arithmetic, 9.7. Handwriting, 9.0. Drawing, 9.5. Handwork, 10.0.

[Here, and elsewhere unless otherwise stated, intelligence is assessed in mental years by means of the London Revision of the Binet-Simon Scale (see p. 281; and for the meaning of "mental ratio" see p. 283). Attainments are assessed in terms of the equivalent educational age.]

*Temperament:* Normal and stable.



FIG. 5. TOMMY B., AGED 10<sup>1</sup>/<sub>2</sub>





was missed from a teacher's drawer ; and since Tommy had been one of a trio left alone in the room during playtime, suspicion pointed its finger not unnaturally in his direction. I was called to examine him.

He was a wizened little imp, with the body of an infant and the face of an old man. Clad in the cast-off garments of some tall adult, dangling his legs and arms as if they were sticks, not limbs, he shuffled towards the master's desk like some strangely animated scarecrow. His age was given as ten years four months. He looked barely eight. I weighed him and measured him. His height was 119.8 centimeters—the height of an average boy of eight ; his weight 21.9 kilograms—the weight of an average boy of seven. He bore signs of past rickets and had all the telltale symptoms of a half-famished starveling—pale skin, pinched lips, puffy eyelids, sunken eyes, and shrunken cheeks. To feel his ribs with the hand placed underneath his coat was like stroking the corrugations of a washboard. In general intelligence he was but little below the true level for his age ; in educational ability he was backward by about a year—no very unusual shortcoming for a child of his poor district. A steady search revealed no inborn defect of temperament or character, no secret discontent or fretfulness, and but little conscious realization of the burden of his lot.

The theft at school he stoutly and convincingly denied, and his protests were soon confirmed by the confession of an unsuspected culprit. The thefts from shops and costers' stalls he owned to without shame or hesitation. With a touch of the expert's vanity he explained the tricks and stratagems that he had devised ; and clearly regarded all keepers of shops and stalls as fair and legitimate game. Careful inquiries showed that he had never stolen actual cash nor, in truth, with trivial exceptions, anything but edibles ; neither had he ever pilfered from home.

Out of school he knew no game or hobby. Evening after evening he spent in the littered streets, among the cabbage leaves, torn newspapers, and offal of the market, prowling round the street-vendors' barrows and trucks. He had become, indeed, "a snapper-up of unconsidered trifles." Often he had first

knocked them down himself; and if the salesman's eye veered towards his direction, of course, his little hands were considerably replacing goods that had slipped off by accident. A favorite source of revenue was to "nick a bit of wood," chop it up with a blunt carving knife, and hawk the fire sticks round for halfpence. With two halfpennies you could get into a coffeehouse and ask for a cup of tea; and then "you could nab a lot o' leavings." (The merry twinkle that went with the mention of "leavings" conveyed that this also was a euphemism.) "But," he added, lest I should miss the essence of the ruse, "you must get your copper fust." It was plainly a point of pride to think how much cleverer he was than the big rich customer who paid for bread as well as for tea and yet forgot to preserve his scraps. I heard afterwards that the keeper of the coffeehouse was cleverer still; for he knew the boy; and—doubtless with a flicker of his own charitable eye—scattered a few "leavings" purposely about.

Tom had a younger brother, Arthur<sup>16</sup>—a puny dwarf of eight, with an eager, darting glance and a high-pitched, husky little voice. Arthur had no such delicate devices as his companion. Profiting at first by the other's training, his downward course had been more rapid, and he no longer scrupled to take pennies and sixpences either from shop counters or from his mother's mantelpiece. I walked home with the pair of them. Arthur strolled always near the curbstone of the pavement, his eyes upon the ground; presently he skipped up, gleefully gnawing the inside of a banana skin plucked from the garbage of the gutter, and generously offered the tiny end of real banana as a titbit to his brother.

They lived in a one-room den, a "third-floor back" at the top of a three-storied building. Except the basement—the dim,

---

<sup>16</sup> *Age*: 8½. *Home Circumstances and Family History*: (see previous footnote).

*Physical History and Condition*: Weight at birth, 7 lbs. Measles; recent impetigo; exceedingly under-developed and ill-nourished; disposed to slight bronchial catarrh. Height, 117 cm.; weight, 20.5 kg.

*Intelligence and School Attainments*: Mental age, 7.8 (Mental Ratio, 96). Reading, 7.5. Spelling, 7.0. Composition, 7.0. Arithmetic, 6.8. Handwriting, 6.5. Drawing, 8.0. Handwork, 7.0.

*Temperament*: Normal, but slightly unstable and unexpressed.

damp, semi-subterranean quarters of the landlord—every corner in the house was sublet; and the tenants were of the poorest and most pitiable class. Three grimy babies sprawled on the steps. Within, the doors were half off their hinges; the wall-paper hung in shreds; the bannisters had been broken away for firewood in the winter; the ceiling of the passage was stained with wet, and its splintered laths sagged out through circular holes where the plaster had dropped down in slabs. To all the smell and squalor of the staircase the narrow room I entered disclosed an unexpected contrast. It contained, indeed, no stick of furniture except a bed and five upturned packing cases for tables and stools; but the walls, the floor, the teapot and kettle of dented tin were all conspicuously clean. On the mattress a wreck of a man lay gasping in consumption. The mother explained apologetically that she did the best she could on eighteen shillings a week earned precariously by charring. The diet of the family was of little else but bread, margarine, and tea, for every meal; and there were days when even these were not to be procured.

The raids and petty robberies of this diminutive pair sprang solely from hunger. On the father's death, six weeks after my visit, a sympathetic friend sent the two orphans to a country home; and as soon as they were well fed all pilfering ceased. They improved with amazing rapidity in health, appearance, and behavior. Tommy, when I next saw him, though still muffled up in rags, was so plump and chubby as to be barely recognizable. With both I have kept touch for over ten years; not the smallest suspicion of dishonesty has attached itself to either of them since.

In many other instances, less striking than the above, I have found that a family table well supplied would quickly put a stop to stealing. In general, however, owing largely to free dinners,<sup>17</sup> thefts of this type among school children of today are comparatively rare. Among adolescents and adults larceny from sheer hunger is more frequent, and, of course, is apt to be proportioned to the prevalence of unemployment. With a

---

<sup>17</sup> Now provided under the Education (Provision of Meals) Act (1906).

lad in the middle of his 'teens, poverty, though temporary, since it means shabby clothes and a weakened look, is of itself a heavy handicap whenever he is tramping after a job; and at the same time it lowers, not only strength and stamina, but self-confidence and self-respect. It is significant that within the ranks of the necessitous and the unemployed, the famished thief is more usually a youth or a man than a woman or a girl. Women, like children, steal less from reasons of necessity and more from a hankering after minor luxuries of life. For one thing, the starving woman has a second alternative, safer and sorrier than outright theft. But this is not the only explanation. The sex difference, though less pronounced, shows also among quite childish cases, and must spring in part from some deeper and more general quality of the feminine body or mind. "Aged men," says old Hippocrates, "endure fasting most easily; and women far better than men; young persons bear it ill, and, worst of all, young children, particularly lads of a vivacious spirit."<sup>18</sup>

Where privation is not extreme yet still oppressive, it operates in ways more subtle and indirect. The family may be above, not below, the poverty line. Every member may seem well fed, well shod, well clothed, even deceptively genteel. No one goes lacking in what is absolutely needful. But there is an exacting obligation for strict economy imposed on each in turn. Hence, innumerable childish trespasses—an act of waste, a heedless breakage, the appropriation of a cake or biscuit, or of some household oddment for a toy—peccadilloes that in easier and more prosperous homes would be passed lightly over, become in the eyes of the thrifty careworn mother, heart-rending crimes.<sup>19</sup>

---

<sup>18</sup> *Aphorisms* (460 B.C.).

<sup>19</sup> Here is a typical complaint, or at least a *verbatim* extract from a long, complaining monologue. A poor working widow of fifty-five, "a charred and broken piece of womanhood," brought to me a willful, playful, yet delightful little innocent of eight with charges of incessant thieving: "Ever since he could walk," she declared, "and before that, he's been taking things he shouldn't. The minute I turned to my work he'd get the matches and be sucking at them, or tugging the table-cloth till everything fell on the floor. As soon as he could reach the table on tiptoe he'd be stealing lumps of sugar or dipping his finger in the condensed milk. And now whenever he comes in from his play, it's



The child himself cannot yet grasp the need for such frugality, and should he prove more active, more inventive, and more alert than his parents, he speedily drifts into habitual trickery, taking things by stealth and cloaking his accidental damage by lies or by deceit. Thus, unless such a youngster keeps back the most natural desires or faces with a cheerful heart repeated refusal and incessant reproof, the impoverished home all unintentionally supplies a most effective training school for dishonesty and guile.

Poverty of yet milder forms may still become disastrous when following prosperity and comfort. Its effect is then heightened by what in other connections the psychologist would call "successive contrast." Some of the clearest cases in my whole economic group have occurred among children whose families have suffered some financial catastrophe and for a time have gone down and gone under.

Not long ago a well-dressed girl of fourteen was brought to me for stealing. In build she was frail and angular, and, with her big teeth, big nose, and big ears outstanding from her head, her looks were far from prepossessing. Her small eyes were nevertheless bright and active; her manner and her gaze were frank; and her smart staccato way of speaking gave the impression of quick wits combined with strong emotions.<sup>20</sup> At ten

---

'Mum, can I have a bit of cake?' And if I wasn't there to ask, he'd just grab it. He's always taking things to play with: and he's that careless, whatever he takes he'll smash; and then, of course, he tells a lie because he knows I'll pay him. Once he smashed a lovely vase that was on the mantelpiece. I never found that out for a long time because he said the cat done it. That's what he always said. If he'd come in thirsty, he'd drink the milk and say the cat done it. Then the other day he wanted a piece of rope for a wheel cart he'd made, and he finds a bit of sash cord in the cupboard what his big brother had been keeping for months and months against wanting; and he takes and cuts that up into little bits. Now his brother goes to mend the blind; and, of course, it's gone; and who's to pay for a new piece of cord?" And so forth, with all the pathetic volubility of a worried mother with a lively child.

Of these boyish pranks not one would be seriously considered in any but a needy home. But where every penny and every fraction of a penny has to be jealously counted, the loss and wastage, however trifling, become matters for dire reproach and drastic punishment.

<sup>20</sup> Rose C. Age: 14½. *Home Circumstances*: Father, aged 42, a small tradesman in a provincial town; business prosperous during war,

and a half she had won a scholarship; and had since been attending a secondary school. Until a year ago her conduct had been unimpeachable; then suddenly she was detected in a succession of thefts.

During the war her parents had risen to comparative affluence. She had received for pocket money, in addition to the expenses of fares and meals, as much as five or six shillings a week. As a result, she had grown into the habit of at once indulging herself in any harmless little pleasure, whenever it appealed to her childish taste. A gay hair ribbon, a gilded hair slide, pastries, chocolates, toffee-de-luxe, were bought the

then declining: he was a man of but moderate intelligence, easy-going ways, rather dominated by his wife, and too engrossed with his business to have much interest in home concerns. The mother, a blanched and bony woman of 45, was a person of more pride and culture than her husband, assertively conscious of her descent from gentlefolk. She talked in strangled contralto, with picked phrases like a book; indeed, with her rather tense manner and her overemphasized remarks, she seemed to be always feeling in italics and thinking in capitals. All this had jarred and grated on the child's raw nerves. Yet in spite of affection and would-be forcefulness, the woman proved quite amenable to advice; and her subsequent understanding of her daughter's situation proved the chief factor in the child's reform.

*Family History:* Father's family all said to be healthy. The mother and the child's maternal grandmother suffered from rheumatism; the maternal grandfather had been a country clergyman; and the mother's only brother was a man of high intelligence—a secondary schoolmaster with an honors degree. It was from this side apparently that Rose inherited her intelligence. She had one younger sister, aged 11, normal in health, intelligence, and character.

*Physical History and Condition:* Measles, chickenpox. Said to have had rheumatic fever at five. Health now normal but not robust. Puberty not commenced. Height, 14 cm.; weight, 38 kg.

*Intelligence and School Attainments:* Mental age, 15.5 by the Stanford-Binet Scale (such an estimate is not very exact for older children of more than average intelligence: on a percentile scale not more than five children in a hundred of her age would be above her). Reading, 16.0. Spelling, 15.5. Composition, 16.0. Arithmetic, 15.0. Handwriting, 14.5. Drawing, 15.0. Handwork, 15.0. (Assessments in terms of educational age when above 14.0 are always arbitrary and approximate.)

*Temperament:* A little emotional at times, but shows on the whole a mental balance unusually steady for her age. Sympathetically approached, she proves quite open about her delinquencies, admitting several that had never been discovered or reported, and shows an insight clear and direct into the processes of her own mind.

moment they caught her fancy; and not a week passed but she took her younger sister or an older friend to the pictures. Then came an unexpected break. Trade declined; her father's business fell to pieces; the cost of living mounted; and the family became, not indeed desperately poor, but sorely straitened. At a single stroke, Rose found her weekly remittance cut down to a few coppers doled out with a grudging hand. But the habits of years, the old desires, the unchecked impulses to instant self-indulgence outlived the change. Added to all this, in the background of her mind there now grew up a querulous envy of her schoolfellows, who seemed to be daily flaunting in her face their lavish allowances; their fathers' rich profits, so she fancied, must have hastened her own father's downfall. It was from the very year of these restrictions that her stealing dated. One day when the cloakrooms were unwatched, it looked such a natural thing to abstract some of the other girls' superfluous cash and so redress the balance. After all, thought the girl, is it not excusable? If others are given such large amounts that they grow positively careless and leave their silver where it may easily be lost, is not a sharp, quick-witted nimble-fingered person justified in leveling out the uneven allocation of supplies? The sixpences and shillings taken during the first two or three weeks were spent principally upon school requisites—exercise books for home work, plimsolls for gymnasium, and the like. But presently, as the method seemed so safe and simple, the child proceeded to filch whenever an occasion offered or whenever she felt a reawakening wish for her former little luxuries; and now she began to steal larger sums and to spend them on cakes and sweets.

When at length her dishonesty had been detected, the motives were not hard to unravel: the coincidence of the twofold change—the decline in home circumstances and the sudden deterioration in personal character, both within the same few months—pointed to the obvious clue. Her deeper feelings, her inward mental reaction, she herself was intelligent enough to interpret. She was removed from school, supplied more freely with pocket money of her own, and eventually offered a small but responsible position in an auctioneer's office, where she

could earn a little income for herself. The case is a recent one; but so far there has been no relapse.

### *Common Concomitants of Poverty*

I now pass from the more immediate effects of poverty itself to the further influence of its commonest concomitants.

*Overcrowding.*—Among what I have termed the concomitants of poverty, two call for explicit mention. Of these the first is overcrowding. It is a feature often adverted to in reports of visitors and teachers. Once again we have to ask, what is the precise meaning to be attached to the word? And the answer turns on another question: what is the minimum of household accommodation requisite for health and decency? In my own inquiries I have used the alternative standard suggested in the returns of the census: by an overcrowded home I understand a tenement with more than two adult occupants per room, two children under ten counting for this purpose as the equivalent of one adult.<sup>21</sup> Among my delinquent cases 21 per cent live in such tenements; among my non-delinquent cases belonging, it will be remembered, to much the same social strata, the proportion is nearly but not quite so high, namely, 16 per cent. The proportion for the whole of the county, about the time of my research, was almost exactly 11 per cent.<sup>22</sup>

---

<sup>21</sup> The standard I have taken is a low one. It was my wish principally to pick the extreme cases. Rowntree uses the ordinary official standard, two persons (regardless of age) per room (*Poverty*, p. 206). By this, the more usual standard, 17.8 per cent of the population of London were living in overcrowded conditions at the time of the census for 1911, and 16.1 per cent during the census of 1921. Bowley has suggested a standard more stringent than the official and more complex than my own, namely, one adult person (or its equivalent) per room—children counting as  $\frac{1}{4}$ ,  $\frac{1}{2}$ , or  $\frac{3}{4}$ , according to age (Bowley and Burnett-Hurst, *Livelihood and Poverty*, p. 22). I myself in a few instances have introduced an allowance for sex. According to the official definition, two adults of the opposite sex, whether married or unmarried, may share one room between them, without being overcrowded. In my own classification, wherever I have found a girl of ten or more forced to share the same sleeping room with her father or her elder brother, there I have regarded the family as living in an overcrowded state.

<sup>22</sup> Census for 1911 (assessment based on the lower alternative standard: see *London Statistics*, XXIV, 1913-14, p. 53).

Taking all London borough by borough, the correlation between overcrowding and juvenile delinquency is a high one: the coefficient is .77, a figure larger than that obtained from any other social comparisons made in the table (see pp. 74-75). With the smaller group of fully analyzed cases, taken family by family and contrasted with the average London household, the coefficient of association between the same two features works out at no more than .21. Thus although juvenile delinquents usually come from overcrowded neighborhoods, they do not necessarily come from overcrowded homes. The difference between delinquents and non-delinquents from the same social class, though appreciable, is smaller still. To state, therefore, that among delinquent families overcrowding occurs twice as often as it does among London households generally, is to convey an unfair implication. Compared with homes from the same social level, overcrowding is but 1.32 times as frequent. Hence it is clear that much must depend upon the mode in which each one reacts to the inadequate conditions under which he is housed and has to live.

Overcrowding may operate in various ways according to the different mental disturbances it may set up. Of these the more subtle are greater and graver than the more obvious. Where all ages and both sexes are huddled together within one sitting room, decency is difficult, delicacy impossible, and premature acquaintance with conjugal relations all but unavoidable: under such conditions an early preoccupation with sexual topics develops very readily, and sexual malpractices are not unknown between members of the same household. On looking through my reports I find, in one case after another, three or four brothers and sisters, seven years old and upwards, described as sleeping together in one bed, with their father and mother and perhaps a baby occupying a second bed in another corner, without a screen or a curtain between. Where accommodation is so limited and sleeping space so cramped, it is hard for parents to preserve a proper dignity; and if in addition there are lodgers, boarders, or other families cooped up in the same cramped building, an easy intimacy with comparative strangers is bound to lessen social reticence and to injure self-respect.



Nevertheless, in point of fact the inevitable openness sometimes simplifies for the child, instead of aggravating, the problems of personal and sexual decorum. Where there is little mystery, there is less inquisitiveness. But beyond doubt under better conditions of living and housing, the same desirable simplicity might still be gained at a slighter sacrifice of privacy and comfort.

Less shocking to the casual caller, but often far more serious in its ultimate effects, are the ceaseless friction and recurrent irritation which, even among families the most patient and forbearing, can hardly be prevented while a number of individuals differing widely in wants and in pursuits according to their age and station are kept jostling, every day and all day long, in the closest personal proximity within the four narrow walls of an overpacked apartment. Matters of every sort, including the child's own character and conduct, have perforce to be debated within the child's hearing; and should any altercation arise between the parents or brothers and sisters, then every member of the household, down to the very smallest, is at once affected. To escape the turmoil and to ease their nerves, the tired father and the tireless youngsters so soon as they are old enough prefer to spend their spare time anywhere but in the house; and the mother is only too thankful to be left in solitary peace. It is plain, therefore, that overcrowding is most inimical to the child where the general disposition of the family is emotional—where anger, worry, and sexual instincts are always near the surface.

*Absence of Facilities for Recreation at Home.*—A second and more widespread feature inevitable in the poor and populous home is the lack of free facility for indoor occupation and amusement.<sup>23</sup> For children of the elementary school class there is seldom, even in the best type of dwelling, a nursery or play-

---

<sup>23</sup> How general such inadequacy is, the figures in my table fail to show. In the whole series there were scarcely a dozen homes in which the facilities were equal to the needs of the children and were freely granted them. In the table, however, to make a just comparison, I have counted only those cases where the lack of space and means was absolute.

room. In the poorest the same stuffy garret serves as parlor, kitchen, and bedchamber in one; and within this sole and single apartment the tiny children have to play and the older children to welcome their friends or else find a place of resort out of doors. There may be, indeed, even in the wretchedest district, a yard or a narrow garden at the back; but it is usually the perquisite of some jealous adult and is monopolized for fowls, rabbits, or potatoes, or for the hanging out of her own or other people's washing: children are trespassers and romping is tabooed. Thus the regular playground of the London school-boy comes to be the pavement of his street. It is to the street that the harassed mother despatches her turbulent flock when she wishes to be quiet, or wants the one small living room free for the reception of visitors, for a tranquil afternoon's nap, or for cooking, scrubbing, ironing, and the like. And it is in the street, as we shall learn in a moment, that the chief opportunities present themselves for the petty misdemeanors of the young. At a later age the needs are different; but the difficulties and their eventual outcome are much the same. The older boy must meet his mates at the corner of the road; the older girl must chatter to her friends in the alleys or the parks: each would blush to bring the others home to tea. And where the only place for recreation is a public thoroughfare or a darkened lane, it can be little wonder that the daytime sees larks and adventures which are against all by-laws and bring the young sportsmen into quick collision with the police, and that the evening goads on the older ones, more skilled in avoiding detection, to yet more perilous pastimes—gambling, flirting, exploring forbidden premises, joining together in hooliganism, in wanton damage, and theft.

Even in the few families with sufficient cubic space at home, there is still nothing there to do—no books for the solitary child, no draughts or cards or dominoes for the child with company. Toys, building blocks, meccano outfits, are luxuries for which there is neither cash nor cupboard; and the cheap gifts from friends, and the homemade treasures of the child himself—his wooden engines, airplanes, and windmills—are speedily broken by the heedlessness of babes or adults. Where all exist-

ence is a struggle for bread, life is too stern for the father to waste strength in making or mending his children's playthings, or for the mother to smile upon their noisy racketing, or for any of the elders to take a share in the diversions of the young folk by the fireside. The leisure hours are vacant; and an active mind in a joyless home will soon find mischief for the idle hand.

Our experience at the Riverside Village—a small Leicestershire colony for London delinquents—afforded some memorable demonstrations of the previous lack of recreative outlet, from which the young citizens had suffered at home. Allowed the liberty of the fields and buildings, the first impulse of each new arrival was to start playing frantically, as if never in his life had he played before. How to play, what games to choose, what teams to set on foot, none of them very well knew. No spectacle could be more pathetic than a party of full-grown boys and girls, of sixteen years and over, plunging into babyish buffoonery more appropriate to a child of six, hiding and seeking in the attics and the cellars, parading about with paper helmets and wooden swords, digging smugglers' caves in the garden, or, when all invention failed, merely rushing in frenzy up and down the farmyard shouting vociferously like infants that have just discovered they can run and scream.

The age of childhood is the age of play. If at home there is no place to play in, while the spirited youngster is still a child, then he will be apt to give free rein to his natural liveliness so soon as he finds himself away from his parents' sight or too strong for his parents' control. In the highways and gardens of the countryside small harm would come of it. But in the streets and squares and tenements of the city his boisterous antics are a nuisance, and are likely to be put down as a breach of the peace.

#### *Conclusions on the Influence of Poverty*

These, then, are the chief ways in which the limitations of the straitened home make for theft and misconduct in the young. If we now count up all the entries that have been classed under the head of poverty and its concomitants, we shall find that

they amount in number to as many as eighty-five for every hundred cases. Many of these entries occur against the same individuals. One delinquent in every ten comes from a family wretchedly poor; lives in a home grossly overpacked at night; and is destitute during the daytime of all means for rational occupation. It is probably the conjunction of the three conditions, closely connected, as they are, one with another, that makes such a home environment so favorable a nursery for crime.

Yet only in 3 per cent of the male delinquents, and in not one of the female, could the effects of poverty be called the prime contributory factor. And the same conditions were encountered over fifty times per hundred of the ordinary law-abiding population. Thus, between material circumstances and social misconduct, the relation, after all, is far smaller than might have been supposed. Measured by a coefficient of association, based on the number of families showing one or more of these conditions, it amounts to no more than .15 (Table III, p. 5).

Our general conclusion, therefore, on the influence of poverty must be this. If the majority of delinquents are needy, the majority of the needy do not become delinquents. "Poverty," sings Villon, "drives men to steal, as hunger makes the wolf sally forth from the woods." "But is not this," asks Stevenson, who quotes the line, "a calumny on the noble army of the poor?"<sup>24</sup> Poverty can only engender crime by its ultimate action, through ways more often circuitous than plain, upon the inner mental life of the potential offender. Even where its influence seems comparatively straightforward and immediate, the poverty that counts is, as a rule, not absolute poverty, but relative poverty—the ratio of available means to irresistible desires; and this relative poverty may be induced quite as much by extravagant wants as by an insufficient income. "Poor and content is rich, and rich enough"<sup>25</sup>; and the epigram of the stoic philosopher is as true in modern London as it was in

---

<sup>24</sup> R. L. Stevenson, *Familiar Studies of Men and Books*, "François Villon," p. 143.

<sup>25</sup> Shakespeare, *Othello*, III, iii, 172.

ancient Rome: *Si ad naturam vives, nunquam eris pauper; si ad desiderium, nunquam dives.*<sup>26</sup>

## 2. Defective Family Relationships.

The next group of environmental conditions is a group that is easily overlooked and far less transparent in its working. They may be brought together under the general heading of defective family relationships.

Inquiring into the domestic circumstances of case after case, the investigator cannot fail to be struck with the marked recurrence of one suggestive item—the presence of a foster parent. The foster parent is, in most instances, a stepmother; in others, a stepfather, a grandmother, an aunt, or some guardian or recipient related neither by matrimony nor by blood.

With a light heart and with little reflection, people from these social levels join in the most solemn of human obligations. "Marriage," says a well-known writer, speaking of the London poor, "is the commonest of all juvenile offenses."<sup>27</sup> The thoughtless begetting of children, adds the cynic, whether an offense or a virtue, is certainly commoner still. Husbands may be wedded at nineteen or twenty; young mothers may die at twenty-five or thirty; and the widower looks round again for another cook for his meals, another nurse for his family, another housekeeper for his home. In not a few cases the first or actual mother was not a wife at all, and the child himself illegitimate.<sup>28</sup> It is only natural if the second or adoptive mother is more impatient or indifferent than the former; sometimes, indeed, she may be scrupulously gentle; but in other cases, more especially when possessed of offspring of her own,

<sup>26</sup> "He who lives a simple life of nature, will never be poor: he who lives according to his desires, will never be wealthy" (Seneca, *Epist.* xvi).

<sup>27</sup> A. Paterson (now one of His Majesty's Commissioners of Prisons), *Across the Bridges*, p. 131.

<sup>28</sup> On *Illegitimacy as a Child-Welfare Problem* see especially the monograph with that title by E. O. Lundberg and K. F. Lenroot (U. S. Children's Bureau Bulletins, No. 75). According to this inquiry, among state minor wards misconduct is nearly twice as common with children born out of wedlock as with children born in wedlock; it is reported in 28 per cent of the former and in only 16 per cent of the latter.



she bears out the tradition of stepmothers and is actively jealous and hostile. In either event, whether she manifests the imputed prejudices of the legendary step-parent or not, the sense of such anomalous relationships, even if but half realized by the child, is bound to tinge and distort his developing outlook upon social relations as a whole.

Almost as difficult is the position of those homes where, though no stepmother or stepfather has been added to the household, one or other of the parents is dead or has deserted, or has been separated or divorced. The war, of course, was constantly removing, either temporarily or forever, the controlling hand of a father or big brother; the mother had thereupon to work during the day, and would be absent throughout the very hours when the child needed her vigilance at home. Families so diminished or bereaved have helped greatly, during recent years, to swell the ranks of youthful crime. In other instances, upon one ground or another, the child himself may have long been separated from his parents, living for a large portion of his early life with a foster mother, or with a relative, or in an institution away from home. Such intervals of absence have always a more or less unsettling effect; and when the growing child, perhaps on account of the trouble he gives, is handed along from keeper to keeper and changed about from place to place, it is hard to expect any solid habits of self-discipline to develop or any steady code of right behavior to be formed.

Finally, it is surprising to notice how, again and again, the delinquent is the only child in his family. Often, if not actually the only one at the time of the inquiry, he has been so during his earlier years: he is the eldest, and his brothers and sisters are late additions and still tiny. Or again, he himself may be the only child in another sense: he is the youngest of the family and all the other offspring of his parents are grown up and so no longer children.<sup>29</sup>

---

<sup>29</sup> The spoiling of the oldest child, of the youngest child, and of the only child, has become a commonplace with those who study the neurotic. But it is not sufficiently noted that the child who comes second or later in the family without being the last may suffer and react just because

The cases that fall under these various subheadings are, as the table shows,<sup>30</sup> more than twice as numerous among the delinquent as among the non-delinquent. The coefficient of association is, therefore, correspondingly high. It rises to .33.<sup>31</sup> Girls seem to suffer more severely than boys: among the delinquent boys defective home relationships were noted over 110 times per hundred cases; among the delinquent girls over 150 times. In all nearly 60 per cent of the delinquent children had been handicapped in one or more of these ways.

It is, then, abundantly clear that the boy or girl who does not make one of a normal family labors beneath a heavy disadvantage. The ordinary child in an ordinary home is the member of a small and self-contained society, cared for by the united efforts of both father and mother and possessing at least one other relative of his own age and outlook to play with him, to grow up with him, to keep with him, and so to some extent to regulate his ways, or at least to report on any serious fault. The delinquent child, too often, is devoid of all such benefits. He leads an existence warped, one-sided, incomplete, and lacks the most natural check against lawless behavior.

### 3. Defective Discipline

Of all environmental conditions, indeed of all the conditions whatever that find a place in my list of causes, the group showing the closest connection with crime consists of those that may be summed up under the head of defective discipline. Such features are encountered five times as often with delinquent as with non-delinquent children; and the coefficient of association soars to .55.

Home discipline may be too strict, too lenient, or virtually non-existent. Over-strictness was reported in 10 per cent of my cases. Excessive punishment imposed by a parent may at once call forth some challenging counterstroke—either by swift and open retaliation, as in physical assault or instant flight from

---

another is indulged and he is not. Parents are seldom versatile enough to adjust themselves with equal fairness to all the different types and temperaments they may launch upon the world.

<sup>30</sup> See Table IV, pp. 62-3.

<sup>31</sup> See Table III, p. 51.

home, or by devious ways and hidden mental processes, as in reactions more indirect, like theft, embezzlement, or a dissolute life. The sexes differ a little in their mode of response. In most instances, but not all, it is a boy who receives, and a father who inflicts, the harsher forms of castigation; and it is the boys who retort with the most desperate reprisals. I have known a bright and sturdy lad of twelve, flogged for a bad report from school, go straight from the house, steal a couple of pound notes from a shopkeeper's till, and take a train to Brighton for a week-end's wild adventure. The girls suffer more at the hands of the mother; and with them it is less often actual blows and buffets that provoke barefaced defiance, but rather the ceaseless bickering, the groundless complaints, and the perpetual round of paltry restrictions, that in the end set up a mood of sulky mutiny. The effect, as a rule, is cumulative. The hourly nagging for neglected tasks, the daily slap for noisiness or carelessness, or simply the irksome restraints of a puritanical code, become in the end too oppressive to bear; the child broods, and in brooding doubtless magnifies her grievance and ill-treatment; then, after little or no warning, the actual precipitating impulse, the spark that fires the train, flashes up in a second from some trivial scene. In other cases there may be no sharp crisis and things may never work their way to undisguised revolt. To escape chastisement, to baffle rebuke, and to gain his private ends, the child finds it easier to cultivate the habit of deceit and double-dealing. At most, he becomes disputatious and begins brazenly to lie. Downright rebellion may never occur to him; and yet, not only towards his parents, but to all social authority whatever, his general attitude grows at length into a deep antagonism, silent, sullen, and sustained.

Even commoner than a discipline that is over-severe is a discipline too weak and easy-going. It is reported in one case out of every four. The laxity may spring from various causes which, separately or together, paralyze the ruling hand. Sometimes it arises from physical defect or ill health: the parent, grandparent, or other guardian of the child, may be incapacitated by age, by lameness, by deafness, or by some chronic or constitutional disease. Sometimes the misguided leniency re-

sults from feebleness of mind or morals: the parent may be too dull to exercise due vigilance; too ignorant to adopt effective measures; too emotional in prohibiting, rebuking, or punishing to preserve strict justice and proportion. One constantly recurring situation develops in the poorer home. The underfed, overworked mother, with a large and boisterous family, short of money, short of space, and short of time, is often physically weak and mentally slow; not over-competent, as a rule, in household management; and sometimes harassed to the verge of nervous breakdown by the twofold strain of keeping her spirited youngsters in hand, and of making both ends meet. The father, if he has not already abandoned a home so comfortless, is out at work for most of the day and "round the corner" or "up the street," assuaging thirst and nerves together, for nearly all the evening. Should one of the livelier boys, the possessor of far more energy, leisure, and shrewdness than his worn and distracted mother, take to unprincipled mischief, it will be much easier for him to play upon her feelings than for her to appeal successfully to his; he can laugh, argue, and intimidate; and turn himself to any disobedience that he chooses.

Most frequent of all, and most disastrous, is the union of license and severity within the same home, perhaps in the person of the same capricious parent. Who has not met the spasmodic, alternating, forcible-feeble type of treatment so common among the less intelligent families, where the child is first petted and then smacked, one minute coaxed and cajoled into good behavior and the next minute abusively scolded or incontinently whipped; where the mother worries, weeps, loses her temper, and hysterically tries every emotion in turn, but never thinks of calm, consistent, rational restraint? Discipline so irresponsible is no discipline at all. Brought up on such inconsistent principles, the bright and unscrupulous scapegrace soon learns how to pull the strings of his parent's oscillating humor, so that he can extort bribery and affection when he wants it or, when he prefers some pretext of injustice, he can goad his mother to such a state of wild exasperation that some over-hasty action is inevitable, and she is thus placed cunningly in the wrong. If

the two parents have two opposite codes and standards, if one does all the shielding and spoiling while the other plays the stern and stringent martinet, then the methods of each stultify those of the other. Sooner or later the incompatibility may reach the pitch of open disagreement; there may be high words and sharp recrimination over the management of the child; and then, while the pilots are wrangling about the course, the ship drifts on to disaster.

Finally, there may be no attempt at discipline whatever. Of all forms of neglect, moral neglect is the most fatal; physical neglect may be more visible to the eye and more tangible to cope with but it works far less harm. Once more the ulterior reasons vary. Sometimes the parents are merely supine. Sometimes they will own that the child was never wanted; and disclaim all interest in his welfare. In either case they passively permit him to follow his own way; and at the worst they may be tacitly trusting that before long he will stray into some trespass so extreme that the State will at last interpose, take him off their hands, and so relieve them of a responsibility which they never in earnest accepted.

#### 4. Vicious Home

##### *General Influence*

In my list of domestic factors the fourth and the last is the vicious home. The deliberate training of a criminal child by a criminal parent, the shameless fostering of wrongdoing by outright instigation or by mute connivance, is now in London, so far as can be detected, extraordinarily rare. Two cases I have come across where boys were told and taught to pilfer by their parents, who were themselves professional thieves; and three or four cases where girls were either urged or encouraged by their mothers into modes of livelihood still more degraded. But these were exceptional. Vicious precepts are far less common than vicious examples; and as a rule the example is not so much directly copied as indirectly absorbed as a disturbing element or demoralizing atmosphere. To know that his own father is in prison or his own mother a profligate is quite sufficient, without any open incitement, to turn a child's thoughts towards lawless-



ness and vice. To lose respect for one's parents is to lose respect for oneself, for one's fellows, and for the whole basis of morality.

### *Parental Alcoholism*

Of all the features of the vicious home, the commonest and the most remarked is drunkenness (Table IV). On this one point alone, indeed, too much stress is not to be placed. In homes from these lower social levels, a lack of sobriety is no unusual failing. Nevertheless, among the families of the delinquent it is found almost three times as often as among those of the non-delinquent; and, as the table shows, its effect is graver upon the girls than upon the boys. It is important never to regard drunkenness as a factor by itself: almost invariably it is but a symptom, a single and conspicuous aspect, of a wider and more complicated situation. Excessive drinking in the parents may exert its influence in various ways. /To begin with, it may be a sign of inherent instability of temperament likely to reappear in the children. Again, whether or not alcohol circulating in the blood at the time of procreation damages the germ cell, there can be no question that if imbibed by the mother too freely during pregnancy, it may grievously injure the growing fœtus. Thirdly, for the impressionable years of childhood, a drunkard's home is one of the worst conceivable. Money is squandered; health and discipline are neglected; the family is despised by the neighbors; and a perpetual life of discord, irregularity, and passion is created and sustained. The parents abuse and maltreat both their children and each other. Indecency of speech and behavior becomes rife, and the violence, whether of word, act, or feeling, is apt to induce a deep-seated revulsion in the growing girl or boy.<sup>32</sup>

---

<sup>32</sup> The reader who desires a more detailed discussion of the influence of alcohol may be referred to the chapters on this subject in Aschaffenburg's *Crime and Its Repression* and in Healy's *Individual Delinquents*, and to the various references there given. Among English investigations, the important work of Pearson and Elderton (*A Second Study of the Influence of Parental Alcoholism*, 1910) has demonstrated, if it has done nothing more, the statistical difficulties which beset all inferences upon the general problem.

The conditions, however, that mark the vicious home may be of the most diverse kinds: intemperance is but one. Crime, brawling, bad language, irregular unions contracted by the parents, immorality on the part of other inmates of the house, sexual molestation of the child by its own relatives, heartless or brutal usage in countless forms and varying degrees, all tend to set up, by their progressive effect upon the young and sensitive mind, such a sense of injustice, such feelings of indignity, wretchedness, and apprehension, that, as he grows more critical and independent, he finds himself at length impelled to seek relief or distraction by some vehement deed of his own. He may lose all self-command, and blindly strike an offending or unoffending party. He may hand on the maltreatment to one of his own tiny juniors, hurting as he has been hurt, cursing as he has been cursed. He may seek to escape it all by refusing to live with his family, perhaps supporting himself by theft or by other immoral means. The majority of the reactions are indirect. The simple imitation of the parents' own iniquities—stealing if the father is a thief, soliciting if the mother has been a courtesan—though it seems to the layman the most natural, is in point of fact the rarest of the results provoked by such a plight.

### Summary

These, then, so far as they can be classified at all, are the chief conditions met with in the young delinquent's home. The actual figures for their frequency have been presented in the tables above.<sup>33</sup> Altogether, vice in the home was noted in 26 per cent of the cases; poverty with its concomitants in 53 per cent; defective family relationships in 58 per cent; and defective discipline in 61 per cent. Poverty, however, as we have seen, together with defective family relationships, was noted with much frequency among the non-delinquent; hence, they have less significance than might at first be thought. On the other hand, among the non-delinquent vicious and ill disciplined homes were comparatively rare, the proportions being only 6 and 12

---

<sup>33</sup> Table III, p. 51 (percentages for the separate conditions); Table IV, pp. 62-3 (percentages for the separate families).

per cent respectively. As before, we can take the two sides into account by contrasting, not the raw percentages, but the calculated coefficients of association. The order of importance is then somewhat changed. The coefficients are: for poverty, .15; for defective family relationships, .33; for vicious homes, .39; and for defective discipline, .55. The figures speak for themselves.<sup>34</sup>

### Treatment

In considering what treatment shall be prescribed for the young offender, it is well to have in mind the specific measures

---

<sup>34</sup> On the general importance of home conditions in reference to juvenile crime see more especially Breckinridge and Abbott, *The Delinquent Child and the Home* (1912), and E. H. Shideler, "The Delinquent Boy and the Home," *Journal of Criminal Law and Criminology*, VIII (1918), i, pp. 1 *et seq.* Of more special studies of the problem, one of the most suggestive is that of Dr. J. H. Williams (*A Guide to the Grading of Homes*, Whittier State School, Research Bulletin No. 7, 1918; *cf. id.*, *The Intelligence of the Delinquent Boy*, 1919, pp. 163-75). Dr. Williams points out, more particularly, how vague are such descriptive terms as "bad home" or "poor surroundings," and how invalid are the usual inferences drawn from such characterizations. He suggests a short quantitative scale for grading home conditions, based upon the principles employed in recent rating scales for grading personality. The general state of the home he divides into five factors or aspects: (1) necessities (the provision of food, clothing, and shelter); (2) neatness (including sanitation, cleanliness, tidiness, and taste); (3) size (relative to the number of inhabitants); (4) parental conditions (including not only character and intelligence, but the degree of marital harmony); and (5) parental supervision and control. As with personal rating scales, each aspect is given a mark upon a scale of five points, and each point is standardized by reference to a detailed and concrete description of a typical home. The average of the marks is then taken as the "home-index." From his analysis of the data obtained with this method, Dr. Williams concludes that there is "little justification for treating home conditions as a dominant factor in the production of delinquency." Unfortunately, however, his conclusion seems vitiated by the fact that he has first averaged the separate conditions graded, quite regardless of their specific nature and influence. As we have seen, the size of the home, and the extent to which it provides the usual necessities, have little to do with the production of crime. And we may readily agree with Dr. Williams that the factor of poverty has been too hastily seized upon. On the other hand, what he terms "parental conditions" and "parental supervision" undoubtedly play a considerable part; and in the "home-index," as thus computed, these two important factors are likely to be obscured by merging them with the other three.

imposed or indicated by the law. The alternatives set forth by the relevant statutes plainly look upon the offending child as one who yields, willfully or helplessly, to the temptations and influences of his social surroundings; the view that the offenders' own mental state may differ greatly and call in different individuals for very different remedies, is a view too recent to have affected the legal code. Of the various acts of legislation, introduced during the past fifty years to cope with the general problem, the most comprehensive is the Children Act of 1908. Part V of that Act (Sections 94 to 113) deals explicitly and by title with "Juvenile Offenders." Section 107, with much succinctness and some pride, enumerates no less than thirteen modes in which the court may dispose of children and young persons, charged, tried, and found guilty.<sup>35</sup> The more important of these methods may be touched upon here, since nearly all of them relate primarily to a change of home or of home influence.

---

<sup>35</sup> It may be convenient to quote the full summary at this point: "Where a child or young person charged with any offense is tried by any court, and the court is satisfied of his guilt, the court shall take into consideration the manner in which, under the provisions of this or any other Act enabling the court to deal with the case, the case should be dealt with, namely, whether—

"(a) By dismissing the charge; or

"(b) By discharging the offender on his entering into a recognizance; or

"(c) By so discharging the offender and placing him under the supervision of a probation officer; or

"(d) By committing the offender to the care of a relative or other fit person; or

"(e) By sending the offender to an industrial school; or

"(f) By sending the offender to a reformatory school; or

"(g) By ordering the offender to be whipped; or

"(h) By ordering the offender to pay a fine, damages, or costs; or

"(i) By ordering the parent or guardian of the offender to pay a fine, damages, or costs; or

"(j) By ordering the parent or guardian of the offender to give security for his good behavior; or

"(k) By committing the offender to custody in a place of detention provided under this Part of this Act; or

"(l) Where the offender is a young person, by sentencing him to imprisonment; or

"(m) By dealing with the case in any other manner in which it may be legally dealt with."

In choosing the course most appropriate, there are, to begin with, in any given case, several simple questions which the court or other authority dealing with the child must study before making its selection. First, the possibility of inborn or hereditary defect must be dismissed after medical and psychological examination, before environmental influences can be treated as the main conditioning factor. Secondly, it is almost equally important to rule out the possibility of fixed and irremediable habits. With the treatment of criminal habits I shall deal at a later stage; where the chief factor is some persisting external influence and not some inner propensity acquired as a result, we have then to ascertain whether this adverse influence lies within the home or falls outside it. If it falls outside, then, as a rule, it can be attacked with comparative ease; and, as we shall presently agree, there will seldom be any good reason for separating the child from his parents. But if it lie within the home itself, there are still many further problems which must carefully be weighed. And in almost every case before the best mode of treatment can be fixed upon, the character of the child's own home is the first and foremost point to be determined.

Hence, whatever may be thought of the need for a psychological study of the child, a social investigation of his home conditions must always be undertaken; it should be not only efficient but prompt. Like the psychological study (which the social study may prove to be desirable), the social study should precede, not follow, the court's decision; it should in fact be set in motion the moment the case is reported.

The crucial issue is the probable degree of the parents' collaboration with the court. Do they appear able and do they appear willing to coöperate effectively? If they are both able and willing, then the proper plan is not removal but supervision.

If they are willing to coöperate but unable to do so effectively, whether through lack of means or through lack of understanding, then the court, leaving the child at home under official superintendence, may arrange for some outside agency to furnish financial relief in the one case or expert advice in the other. If the inability to coöperate is due to some insuperable



obstacle—the loss of a parent or the failure to find adequate funds—then it may be wiser to transfer the child elsewhere, though in this case (provided always there is in the child himself no additional factor of habit or constitution) what is needed is not so much a place of correction or reform as a different home and a suitable guardian. If the parents are quite able to coöperate, but seem unwilling to do so spontaneously, then it may still be possible to leave the child with them; but firm or tactful pressure must now be brought to stimulate their inclinations. Finally, if the parents, whether able to coöperate or not, are so vicious and degraded that no effective coöperation can be anticipated or enforced, then plainly the one course left is to take the child away.

### 1. Removal from Home

To remove the child from his family does not necessarily mean branding and stigmatizing him straight away as a criminal unfit for ordinary society, nor yet depriving him of ordinary freedom by incarcerating him in some grim penitentiary, even less like home than his own undesirable tenement. These fears of the uninstructed layman, natural enough in former times, should have now no justification. The principle is simply this: that a substitute for a good home and a deputy for a good parent have both to be found before the child can be redeemed.

Four institutions are named in the Children Act as being places to which such children may be sent—prisons, places of detention, industrial schools, and reformatories.

(a) Prison.—It is hard to realize that, until a few years ago, between two and three thousand children under the age of sixteen were annually consigned to prison; and that, less than a century ago, they were not only forced to await their trial in the common jail, but were liable to be sentenced to death or transportation for petty offenses that today would hardly be thought to warrant a fine. There is on record the case of a boy of eight who “with malice, revenge, craft and cunning” (such were the psychological attributions of those days) had set fire to a barn, and being convicted of felony was duly hanged. So late as 1833 a boy of nine was sentenced to death, though

not executed, for stealing twopenny-worth of paint. After the Royal Commission of 1834, Parkhurst Prison, in the Isle of Wight, was set apart for convicted boys; but the young inmates were still fettered in chains; and while at work were guarded by warders with loaded rifles. In 1875 a girl of thirteen who could not pay her fine was sent to the local jail for wheeling a perambulator on the pavement of a fashionable street; she was found in her cell by the visiting magistrate, who discharged her debt and so secured her release. Even during the first years of the present century, children and young persons awaiting trial or conviction were detained in prison or in police cells, and on conviction might be sent to jail.

It was not till 1908 that such measures were abolished. By the Children Act passed in that year, no child under fourteen may now be sentenced to imprisonment; and no young person between fourteen and sixteen may be so sentenced "unless the court certifies that he is of so unruly a character that he cannot be detained in a place of detention provided under this Act." It would be well if by future legislation, an age yet higher might be fixed.<sup>36</sup> At present, for young lads and girls between sixteen and twenty-one the position is far from satisfactory. At these ages large numbers are still sent to prison, although during the last fifteen years the prison has been increasingly superseded by what are known as Borstal institutions.<sup>37</sup>

(b) Places of Detention.—Before conviction children and young persons apprehended by the police and not immediately brought before the court or released on a recognizance, are to be detained until the hearing of the charge in a remand home or place of detention, provided under the Act just mentioned.<sup>38</sup>

<sup>36</sup> Such, too, is the comment of the last Home Office Report (see *Second Report on the Work of the Children's Branch, 1924, p. 5*).

<sup>37</sup> In 1913 only fifty-two children under sixteen were committed to prison in the whole of England, and in 1921 only seven. On the other hand, the number of adolescent cases so committed still runs into thousands; to this I shall return in a later section on the subject (see below, Chapter V).

<sup>38</sup> Sections 95 and 108. There are now in London two remand homes, both controlled and maintained by the County Council, one for girls and younger boys and another for older boys. A third has recently been closed. Elsewhere such places are provided by the police authority.

And by the same Act <sup>39</sup> a child or young person convicted of an offense punishable in the case of an adult with imprisonment may be committed to a place of detention for a period not exceeding one month. Thus, remand homes, like prisons, serve in theory a double function: they provide a receiving station for those awaiting trial and a place of custody for those already convicted and sentenced to detention.

In practice scarcely one child in a thousand is sentenced to mere detention. In such a sentence, it will be noted, a conviction is implied; and no convicted child can be placed upon probation. Hence, with children whom it seems desirable to detain for a short spell, the practice of the magistrate is simply to remand them in custody. Unfortunately, during the brief periods customary for remand and during the short four weeks permitted for detention, it is difficult to carry out any effective training, or to break, once and for all, any old, longstanding habit; nor is it, indeed, desirable to mix children still awaiting trial and therefore possibly innocent with those already proved guilty: on the other hand, committal to a reformatory or industrial school is nearly always for a long term of years. Accordingly, there is much to be said for the establishing of a separate home or a special place of detention to which children might be transferred for any period up to six months or even twelve. The shock of a sharp, short separation will often rouse the casual offender to his senses and bring his family to a feeling of their own responsibility and blame. Frequently, too, it is inadvisable that a child should return to his home until the home has undergone certain necessary changes, or while the child himself is waiting for a fitter place to be found. A detention house that filled such a purpose might at the same time serve as a sorting center,<sup>40</sup> where the more difficult cases might be re-

---

<sup>39</sup> Section 106.

<sup>40</sup> See Children Act, Section 63 (c).

In America many of the places of detention are most elaborately organized; and often include full facilities for medical and psychological investigations. In many places, as at Buffalo in the United States, and at Montreal and Toronto in Canada, they form part of the same building as the juvenile court—a combination that has obvious advantages; and usually, to prevent contamination, there are complex arrangements for

tained for a few weeks under observation, before determining what particular school or institution seemed most suited to the needs of each.<sup>41</sup> For the present, however, the cost of providing a separate place for detention, as distinct from remand, is likely to make it impracticable; and the requirements meanwhile could be met in some measure by arranging, in appropri-

---

segregating inmates of different types. At Detroit, to describe but a single example, the place of detention includes, besides dormitories, kitchens, and offices for the staff, a hospital, a courtroom, schoolrooms, recreation rooms, and special rooms for records, interviews, and physical and mental examinations. Special opportunities are afforded for manual occupation, so that the vocational aptitudes of the children may be studied. Several social investigators are employed. The superintendent is a qualified psychiatrist, and the psychological clinic that is attached employs the full-time services of three or four psychologists working under the direction of a University professor.

In other American cities, however, there is now an increasing tendency, when children have to be detained before sentence, to send them, not to official remand homes, but to private boarding homes. In Boston, for instance, there is no place of detention: a child who cannot safely be returned to the care of his own parents is boarded out with a private family under the supervision of the Children's Aid Society. In New York such children are received in a huge shelter maintained by the Society for the Prevention of Cruelty to Children, while the remainder are temporarily released under the care of a probation officer or of a "big brother" or "sister."

<sup>41</sup> In this reference I may quote the suggestions made in one of the *Annual Reports* of the London County Council (Chap. xli, 1912, "Special Schools, Industrial and Reformatory Schools and Places of Detention," p. 8): "The question of studying the physical, mental, and moral condition of each child before its permanent committal is one of considerable importance. At the present time all available information with regard to those matters and also the circumstances in which the child has lived, are considered by the industrial school cases section, and observation is kept by the medical officers and superintendents of places of detention to which the children are sent whilst their cases are awaiting decision by the juvenile court. As a general rule, however, the time available and the means at the disposal of the Council are insufficient for reliable information to be gained with regard to these matters. . . . Each education authority should be required to have at its disposal, either for its own use, or in conjunction with one or more other authorities, receiving homes where children would remain long enough to enable the medical and educational officers to arrive at a conclusion with regard to each particular case. When these observations were completed, the children could, on the authority of the education committee concerned, be removed to a suitable institution."

ate cases, that the child should be licensed out from the industrial school after a far shorter period.<sup>42</sup>

Most magistrates and nearly all investigators are, I think, agreed that the remand home as at present organized should be used as little and as briefly as possible. It is needed only for the worst cases—children utterly beyond the control of their parents, children who are an obvious menace to public safety, children whose home conditions necessitate immediate removal, and children whose parents cannot be trusted to produce them in court. Psychological examinations can best be made not in the official atmosphere of a place of detention, but in a separate psychological clinic, day or residential, set up expressly for the purpose.<sup>43</sup>

(c) Industrial Schools.<sup>44</sup>—Children convicted of an offense punishable in an adult by penal servitude, imprisonment, or some lesser punishment may be committed to an industrial school if they are under the age of twelve, and also, even if they are already twelve or thirteen, on two conditions: that they have

---

<sup>42</sup> The provision of separate places of detention for those committed under Section 106 of the Children Act is also recommended by the Juvenile Organizations Committee (*Board of Education Report*, p. 41, Recommendation 16). The figures, however, which the report quotes show that, in the chief town making use of this clause, over 70 per cent reappear at the court within six months.

<sup>43</sup> For suggestions on the foundation of psychological clinics and observation centers, with a brief note on what in this direction has been done abroad, see Appendix II.

<sup>44</sup> The idea of an industrial school seems first to have originated in Scotland about 1850. In 1866 an Industrial Schools Act was passed which consolidated the Acts of previous years dealing with industrial schools and reformatories. The provisions of this Act repeated and slightly amended by the Children Act of 1908 (Part IV, "Reformatory and Industrial Schools"), still virtually remain the law. Industrial schools were thus first established when the views current on child labor were very different from the present; and it was expected that the work of the inmates might largely contribute to the maintenance of the institution. In 1884, however, a Royal Commission on Certified Schools recommended that the profits of the inmates' labor should be a secondary consideration and that premiums to the Governor or staff on the amount of such profits should be discontinued. The Home Secretary now has the right, through his inspectors, to refuse the certificate which secures a Government grant; but here State control practically ends. (For an admirable history of Home Office schools, see M. A. Spielman, *The Romance of Child Reclamation*, Reformatory and Refuge Union, 1920.)



not been previously convicted, and that they are unlikely to have an evil influence over others in the school. In addition, when under the age of fourteen, children beyond the control of their parents, children disobeying an order of the court for attendance at school, and children found begging, wandering, homeless, or destitute, or in the company of thieves, prostitutes, or criminal parents or guardians, may likewise be sent to an industrial school. The period for which the offender is committed may be such as the court thinks needful for his proper training and instruction, provided that it extends no further than the age of sixteen. Many industrial schools, however, require that the child shall be transferred to them for the full time permitted by the law. But under certain circumstances they are empowered to release him on license, should they think fit, before the term of committal has expired. Except in cases of non-attendance at the elementary school, the child remains under the supervision of the managers of the certified school until he reaches the age of eighteen.

The majority of these schools are under private management; and hence their methods, their ideals, and their efficiency may differ greatly from one to another, and even from year to year. A few are managed by the education committees of the town or county councils. But owing to the wide divergences in discipline and tone, it is vital that whenever possible a careful choice should be made, so that the place to which each child is sent shall be the one best adapted to his individual needs. Under the Children Act a child must be committed to a particular school named in the order of detention. It might perhaps have been better had it been provided that the court should simply commit the child to the care of the local education authority, and that the local education authority, after first retaining the child in a special receiving home for observation and inquiry, should itself select the fitting institution.

It is to be urgently hoped that, as coördination is increased and the accommodation available for special cases is enlarged, some further measures of classification may be introduced into the existing schools; so that they may be more appropriately graded according to the special nature of the cases committed to

each one. As will have been noticed, such schools at present fill two needs: they act as junior reformatories for childish offenders, and they provide homes for those who, through no fault of their own, are found living under dangerous or undesirable conditions. Thus it may happen that a girl of thirteen, who has been frequenting the company of prostitutes, a child of eleven who is a thief, hardened, artful, but otherwise innocent, and an infant of five or six found wandering and destitute, may be all sent on the same day to the same school. But the nature of the legal ground or charge is by no means the sole or even the chief point in differentiation. It is not what the child has done but what he is capable of becoming that provides the true basis for sound classification—a principle which I shall return to and expand in later chapters.

(*d*) *Reformatories.*—By law, youthful offenders between the ages of twelve and sixteen convicted of any offense punishable in an adult by penal servitude or imprisonment, may be sent to a reformatory. A child over the age of twelve committed to an industrial school and found to be exercising an evil influence over other children, may also be transferred thither from the school to which he was first sent. In practice, however, it is rare that children are sent to reformatories before the age of fourteen. The period of detention must be not less than three years and not more than five; and may in no case last beyond the age of nineteen. Up to that age, whether the period of his detention has expired or not, the offender remains under the supervision of the managers.<sup>45</sup>

It will be observed that cases sent to a reformatory are of a graver stamp than those sent to an industrial school. For the most part they now comprise those constitutional or habitual

---

<sup>45</sup> These provisions, since slightly modified by the Children Act, Part IV (Sections 57, 68, and 69), were laid down by the Reformatory Schools Act of 1866. The first reformatory school—a school for girls—was opened at Bristol in 1854, after the passing of the first Reformatory School Act. In the same year the first so-called industrial school was established at Feltham; but, except in point of age, this was not so much an industrial school as a reformatory, since it admitted none but convicted children.

offenders with whom the system of probation has been tried and has not succeeded. Unfortunately there is no special certified institution to which a mild and slight offender just above school age, a young person verging on adolescence and guilty perhaps of only one impulsive lapse, may suitably be sent.<sup>46</sup> However light his crime, the youth received by a reformatory must first be convicted: and the stigma of conviction he must carry for the remainder of his life. No one, therefore, should be consigned to such a place unless reform seems unobtainable by other and more lenient means.

These, then, are the main kinds of institutional treatment recognized by law for young offenders. With the particular types of children who may with some prospect of success be sent to these different establishments I shall deal more fully under subsequent headings. Generally speaking, in recent years there has been a growing reluctance to commit the moderate offender, particularly if young, to any of these schools.<sup>47</sup> "I

---

<sup>46</sup> The Little Commonwealth (eventually certified as a reformatory in name) and the Sysonby Village Colony suggest lines on which such institutions might be planned (see Chapter V). There is much to be said for abolishing the main distinction between the industrial school and the reformatory and regarding them simply as junior and senior branches of the certified school. It would be an incidental outcome of this change that no conviction need then be registered against a child under sixteen.

<sup>47</sup> *A Directory of Schools certified by the Secretary of State under the Children Act, 1908*, has now been published by the Home Office (H.M. Stationery Office, 1924, price 1s.), and describes the scope and character of the several certified schools.

I should add that, during the past ten years, these institutions have been undergoing rapid alterations alike in aims and in methods. "The greatest change," as a recent Home Office Report points out, "lies in the decrease of 'institutionalism'—to use an ugly word for an ugly thing": greater attention is given to the child as an individual, and he is now brought more into contact with the outer world. Considering the extreme difficulties and impediments that beset their task, the visitor can have little but praise for the notable improvements introduced into the best of the certified schools of today: they no longer form the repressive barracks that uninstructed opinion still too often pictures to itself. But the majority are as yet in a transitional stage. Conceivably, when popular prejudice has been overcome by further progress, there may be a reaction in favor of the reformed reformatory (which should no longer be called a reformatory) and towards the genuinely industrial training of the specialized and enlightened industrial school. None the less, the

am confident," says their late Chief Inspector,<sup>48</sup> "that long periods of detention in any institution, no matter how excellent it may be, do not quicken, but rather deaden, the intelligence." Many magistrates are of a like opinion. "No child," says Mr. Clarke Hall, "should be sent to such schools if there is any reasonable hope that any of the other methods provided by law are at all likely to prove sufficient and effective."<sup>49</sup> These views are reflected in the remarkable decrease in the number of children committed to such places. In 1903 there were 18,916 children detained in reformatory and industrial schools; at the end of 1922 only 9,888.<sup>50</sup> And in London during the same period the proportion of cases actually sent to industrial schools to the total number of industrial school cases reported for consideration has dropped from 40 per cent to 27 per cent. Since 1915 no less than forty-three certified schools have been closed.

As we have seen, there are other ways of removing the child from a bad home to a good one without placing him in a certified school or institution. These still remain to be considered.

(e) Boarding Out.—To condemn to ten years of institutional life a tiny child of six is acknowledged on all hands to be

---

psychologist may be permitted to doubt whether, save for a small proportion of exceptional cases, institutional treatment, however excellent of its kind, must not always be unsuited to the needs of the growing child, just because it is institutional and because the place for the growing child is the home.

A most suggestive program for the aims, methods, and curricula of institutions like the English industrial school will be found in the article by Healy and Bronner, "An Outline for the Institutional Education and Treatment of Young Offenders," *Journ. Educ. Psych.*, VII (1916), v, pp. 310-316.

<sup>48</sup> *Fifty-ninth Annual Report of H.M. Chief Inspector of Reformatory and Industrial Schools, 1916* (the last of this series of Home Office Reports).

<sup>49</sup> *The State and the Child*, p. 22.

<sup>50</sup> *Home Office Report* (1923), Table IV, p. 100. The proportion of cases committed to industrial schools out of all the cases dealt with in juvenile courts has as a result been approximately halved. In 1913 it was 3.2 per cent; in 1915 it rose to 4.6 per cent; in 1922 it was less than 1.6 per cent. In 1923 only 473 children were so committed as against 2,003 in 1915. The proportion sent to reformatories has similarly declined, though not so markedly: in 1916 it was 3.8 per cent; in 1922 only 1.8 per cent.

wrong. Young children who are not offenders but merely destitute have for long been boarded out with foster parents. From our general discussion of environmental influences, it must be clear that small difference can exist between those who are merely destitute and those who, owing to their destitution, have slipped into some slight technical offense—begging, for example, or wandering. By the Children Act (Section 53) the managers of an industrial school may now board out the youngest offenders committed to their charge. The course is appropriate and explicitly permissible for children under the age of eight. Nevertheless, many a school still fails to take advantage of the provision.<sup>51</sup> At present the number boarded out is pathetically few, barely three hundred in all. For nearly every one of them the London County Council is responsible. The results obtained have undoubtedly been such as to warrant a wide extension of the practice. Naturally, to find suitable foster parents and to inspect and supervise the homes,<sup>52</sup> tact and discretion are needed. But it is significant that many of the children elect to stay with their foster parents after the period of their committal is ended. Older children might profit equally by a similar scheme of treatment. Discrimination would, of course, be essential. A boy who from fixed habit or inborn propensity is a wanderer, a thief, or an unmanageable renegade, would be unsuited, it is plain, for such a measure. But where the fault lies with the home rather than with the child's own temperament, a reformatory-residential school is

---

<sup>51</sup> Under Section 53 of the Children Act, the Secretary of State, in June, 1921, made detailed rules for the boarding out of such cases; and issued a circular letter to the schools urging a freer use of this method in dealing with the youngest cases. To this letter useful reference may be made.

<sup>52</sup> Regarding the selection of foster homes, I am eager to stress the need for psychological suitability as well as for physical—for moral fitness as well as for material. The mental and temperamental atmospheres are far more important than the climatic and the sanitary. That the household should be clean, healthy, wholesome, and respectable is not the sole requirement. And what is a good home for one is not necessarily a good home for all. It is, therefore, not enough to note whether the foster parents are desirable persons in themselves, but whether they and those around them are also desirable persons, in reference to the particular child whom it is proposed to transplant into their care.



scarcely necessary. At present the chief difficulty is one of expense. In the Criminal Justice Bill, however, recently introduced by the Home Secretary,<sup>53</sup> there is a clause providing that "it shall be lawful for a local authority to contribute towards the expense of maintaining persons who have been released upon probation under a condition as to residence."<sup>54</sup> If sanctioned, this provision would render it far more easy to board out suitable cases, such as the young and the mentally defective, instead of committing them to a certified school.

If the parent is merely weak, foolish, indifferent, or devoid of adequate means, the child may be boarded out near its own town or city. If the parent is actively vicious, it would be better to board the child out at a distance: a complete severance of all family ties and the building up of new ones is then a charity more than an injustice. For such a case, the system of scattered cottage homes forming a little community of families provides a plan intermediate between the liberty of being boarded out and the inevitable limitations of the certified school; it is a plan that might profitably be tried with many older children who through outer influences rather than from inner disposition have made a false start in life.

(f) Committal to the Care of Other Fit Persons.—Under the provisions of the Children Act, the court may, if it thinks right, commit the offender to the care of a relative or other fit person. Parents who live in London frequently have friends or relatives who live in the country. Justly enough, in such an event the parent may often prefer that his child should be sent away to some one with whom both are already acquainted. Home life has so many advantages over institutional life that this course, particularly for mild cases from better-class families, may be adopted with success.

The terms of the Act also allow the court to select some suitable person neither related nor previously known to the family. A classified list of voluntary homes and institutions willing to take children from courts and other agencies is pub-

---

<sup>53</sup> Ordered by the House of Commons to be printed, March 2, 1925.

<sup>54</sup> Section 4, subsection (2).

lished by the Reformatory and Refuge Union; but, of course, since such institutions are not of necessity under official inspection,<sup>55</sup> the efficiency of the managers cannot always be guaranteed. Most care committee officials compile similar lists of their own, which enable them to supplement and to keep up to date the lists published by the various societies. And in actual practice children are now sent to such homes and to such foster parents by a private arrangement between the parent and the official agency, even more often than by formal committal from the court.

(g) Voluntary Cases.—A child may be received in an industrial school or boarded out with a foster mother as a voluntary case: that is to say, he may, with the consent of his parents, be so removed without first being charged before a magistrate. Usually under this procedure the parents must pay the full cost of maintenance.<sup>56</sup> A private arrangement of such a kind is often a reasonable one where the parent or other guardian may rightly wish to save the child from the slur of an appearance at the police court. It is not, however, yet generally realized that the formation of special juvenile courts<sup>57</sup> has removed many of the objections which naturally obtained when the young offender had to be dealt with through the

---

<sup>55</sup> By Section 25 of the Children Act, the Secretary of State is empowered to cause all voluntary homes for the reception of poor children to be inspected. The records of the National Society for the Prevention of Cruelty to Children show that in the past many voluntary homes have been mismanaged. And it is, therefore, earnestly to be hoped that the powers of inspection will in the near future be fully and widely exercised.

<sup>56</sup> The financial obstacles might be more easily overcome if the clause in the Criminal Justice Bill quoted on page 111 received legislative sanction. With voluntary cases a special source of difficulty is that parents, eager enough to be relieved of trouble while the children are young, are no less anxious to reclaim them when they pass school age and become capable of contributing to the family income. English law has always been so solicitous to safeguard parental rights that these and similar problems—for example, the adoption of children by foster parents and the custody of children whose parents are separated by mutual consent—are often full of perplexities for officials who wish to secure the best interests of the child himself.

<sup>57</sup> By the Children Act, 1908, Section 3. See p. 34, footnote 12.

medium of the ordinary court for adults. It may, therefore, in many instances be entirely to the benefit of the offending child, and not at all to his disadvantage, to seek early the magistrate's assistance and advice.

But under whatever arrangement the child is sent to his new home, one preliminary precaution is essential. The child's needs must be studied before he is placed. To send him away experimentally first to one home, then to another, in the hope that, sooner or later, through trial and error, some suitable household may at last be hit upon, is as detrimental as it is frequent. The constant change, the repeated failure, the shame of successive exposures and expulsions, only help to convince the child that he belongs nowhere and can adjust himself to no one. His requirements must first be explored; and a home suited to his requirements must then be selected, where he may settle down once and for all. For these and other obvious reasons, it is generally better that the mere administrative work of placing the child in a suitable family or home should not be undertaken by the court itself. Other agencies, specializing in such work, are generally available.

These, then, are the various new environments that may be provided for what may be termed environmental cases.

## 2. Improvement of the Material Conditions of the Home

Removal, however, should always be a last or a late resource. After all, wherever it is feasible and wherever the child himself is not already beyond reform, to improve the child's own home forms a far better policy than to take the child away from it. If poverty is the main contributory factor, the aid of private or public charity can usually be invoked to relieve the stress of economic want. Relief will be easiest where the need is temporary—where, for example, the father is for the moment out of work and all that is needful is to tide the family safely over some short crisis. But these and similar objects can only be achieved if the court or the care committee are in close and continuous touch with all the welfare agencies of their district.

The secondary effects of poverty are always to be kept in

mind. What these are and how they may best be remedied must be apparent from the discussion in the earlier sections of this chapter. To relieve the overcrowded home may be at times impracticable. But to see that the child has better facilities for recreation than a poor and populous dwelling can usually supply is often as easy as it is essential. Throughout, however, it will never be enough to amend the glaring visible defects, without first studying their mental influence upon the child. All attempts to rectify environmental factors should proceed from one prime consideration: how have they affected the delinquent himself? Time, money, and labor are constantly lavished upon an effort to ameliorate material conditions which, however much they may shock the cultivated visitor, however sordid and insanitary they may seem in themselves, have yet in point of fact no real psychological connection with the child's misconduct. Among the most impoverished families, illogical as it may sound, what is driving the child to crime is usually not the lack of food or clothing, but the lack of simple pleasures; and to advance money for providing the former while making no move to supply the latter may be simply wasted endeavor. To many it may seem trifling with public funds to put money in the hand of a child when his parents are short of sheer necessities. But after all it is a far cheaper measure to spend a few shillings in giving him the pocket money, the recreation, the toys, the sweets that he desires than to board or lodge him for three or four years in a state-supported institution.<sup>58</sup>

---

<sup>58</sup> What, I am often asked, is likely to be the effect of this upon other children? The reply is, first, that it is unnecessary either for the child himself or for his companions to know the source and special motive of the generosity with which he is used. Secondly, even should they learn or guess, young children are not such profound reasoners as to argue—"Tommy stole, and he gets, not blows and hard words, but sixpences and sweets; I will, therefore, steal, that I may enjoy the same." By older children, such inferences might perhaps be drawn and acted on; and, certainly, with every child, no matter what may be his age, a due discretion must be tactfully observed. In practice, however, the danger comes, not from the liberality, but from the unusual personal interest his case is arousing; and extreme care will always be essential to avoid this coming impressively before the notice either of the rogue himself or of his fellows.

### 3. Fines and Recognizances Taken from the Parent

Where the weakness in the home arises neither from poverty on the one hand nor from low moral standards on the other, but rather from laxity or venial negligence, there the parent's sense of responsibility may be effectively quickened by the imposition of a fine, or by taking his recognizances to insure the good behavior of the child. By Section 99 of the Children Act, when the child is under fourteen, any fine imposed *must* be paid by the parent; when the child is between fourteen and sixteen, it *may* be paid by the parent if the court so orders (subsection (1)). By the same section the parent or guardian may also be ordered to give security for the child's good conduct (subsection (2)).

The latter method is used less freely than it might be. There are many conceivable stipulations which those at work upon the case may well be wishful to have carried out. To change residence to a different district, to withdraw the child from some undesirable employment, to see that he does not frequent the streets at night, that he reports himself regularly to some supervising officer, that he undergoes some course of training or treatment, that he keeps from bad company or from the cinema, or joins some specified club—these and similar undertakings might beneficially be enjoined when the parent is bound over. There is a further advantage in taking the parent's recognizances. Where the parent is required to give security or to pay damages or costs, it is not necessary to convict the child (subsection (3)); but apparently where a fine is imposed, whether paid by the parent or not, then, by some illogicality of the law, the child becomes a convicted person, and consequently, unless he commits some further offense, may no longer be placed upon probation.

### 4. Birching

The most ardent humanitarian, however, is forced to admit that sometimes it is necessary to punish not the parent but the child. Corporal punishment as a general means of breaking habits I shall discuss later on. Here I am concerned only with those rarer instances where the law allows the court to supple-



ment the ineffective disciplinary efforts of the parent and apply a parental whipping as an official form of treatment.

By statute, where the offender is a boy under fourteen, the court may order him to be birched for any indictable offense other than homicide. In effect, however, this means that a whipping can be ordered only for larceny and for one or two statutory offenses, such as throwing stones at a railway train. Of all forms of social justice, to whip the child is no doubt the most simple, the most obvious, the most expeditious, and the least expensive. In the past the rod was the main weapon of correction. But since the retributive theory of punishment has been abandoned,<sup>59</sup> there has been a strong and widespread reaction against corporal penalties, however applied. They are held to be neither reformative nor deterrent. The English *Report on Juvenile Delinquency*, for example, contends that "there remains little or nothing to be said for birching. . . . The use of the birch can do very little good; for one out of every four birched returns in less than one month."<sup>60</sup> The Scottish report concurs.<sup>61</sup> It is true that in the few towns where the relative efficiency of different penalties has been investigated over 25 per cent of the boys sentenced to be birched reappeared before the court within thirty days and over 76 per cent within two years. Indeed, after this mode of treatment there are more reappearances than after any other. But such direct comparisons are scarcely valid. The boys that are whipped include the worst types of repeater.

The proportion of children sentenced to a whipping has dropped from 9.7 per cent in 1916 to 1.8 per cent in 1923.<sup>62</sup> In the New York Court no boys are birched; and in the Chil-

---

<sup>59</sup> De Quirós, in his excellent treatise on *New Theories of Punishment* (Modern Criminal Science Series, 1911), avers that "the old notion of simple retribution, like extinct flora and fauna, has no place in our modern world" (p. 34). So recent and so eminent a writer as Dr. Mercier, however, has revived and maintained the retributive theory, arguing that punishment is essentially based upon "an imperative desire that those who do wrong should be made to suffer" (see his book on *Criminal Responsibility*, 1905, especially pp. 10-13).

<sup>60</sup> *Loc. cit.*, pp. 28 and 29.

<sup>61</sup> *Loc. cit.*, p. 12.

<sup>62</sup> *Home Office Report* (1924), Table I, p. 69.

dren's Court at Birmingham, I believe, birching has been discarded. Yet its absolute and entire abolition seems hardly justified. There is rather a case for reconsidering the limitations of its use—the nature of the offenses for which it can best be applied, the age limits within which it is most appropriate, and the manner in which it may be imposed with the greatest and most salutary effect. Brutality to other children, gross cruelty to animals, endangering the lives of railway passengers by putting obstructions on the line, these are obviously transgressions where the birch may prove an efficacious means of bringing home to the offender himself the sharp significance of pain. Sometimes, too, a whipping might usefully be ordered as the contingent penalty for the breaking of recognizances. Nor does there seem any cogent reason why, if the birch is to be retained, it should not at times be administered in the case of big, defiant, and unruly boys over the age of fourteen. In a few special instances of such a kind, the official administration of corporal discipline might do much to reinforce the authority of the parent; I can, in fact, cite more than one example of an older lad, too strong for his father to thrash, where the same penalty, informally applied by a burly policeman, has had a final and deterrent result. Moreover, a rare and occasional birching, if it does not reform the one boy birched, may yet overawe a dozen others whose nature it is to respond to fear rather than to clemency; and a knowledge that he is risking the rod may be a most successful preventive in the mind of a potential delinquent who is tempted, but who so far has not given way. Generally speaking, however, it would be best if the punishment were inflicted not by the court officer but by the father himself, the court, perhaps, requiring that he should do so in the presence and to the satisfaction of a sergeant of police.<sup>63</sup>

---

<sup>63</sup> Sir John Dickinson, formerly Chief Magistrate at Bow Street Police Court, relates the following incident. On one occasion, when a father and son came before him, Sir John was convinced from their manner that the father was not master in his own house. The custom is that the penalty shall be inflicted in a police cell by the officer in the presence of a parent. Sir John reversed the custom; the father was told that, if he himself would birch his son with the police officer standing by, he might

But the infliction of pain is a negative and desperate form of discipline, to be applied only as a last and exceptional resort. To use it freely is to blunt the boy's sensibilities at the very time when it is most essential that he should be roused to intelligent response. "The best scourge," it has been said, "is the sense of shame";<sup>64</sup> and shame is a tender feeling which a rougher weapon is more likely to kill than keep alive. Once a boy has been flogged, the psychologist finds it hard to regain his confidence and reawaken his self-respect. Far more effectual are continued and constructive efforts, stimulating the past offender to do better in the future by setting before him some positive interest or ideal, by encouraging him wherever possible with reward and commendation instead of merely intimidating him with the stick.<sup>65</sup> The boy from the poor home seldom takes his caning in the same sportsmanlike spirit as the boy from the public school. He is more likely to nurse a secret feeling of resentment, resolving to demonstrate his high indifference when the first chance offers for a backhanded reprisal. If he is a member of a gang, he will boast to the rest of his bravado, and shine before their eyes in a halo. If he is a lonely outcast, he will feel that the whole world is brutal and become brutalized himself. Many young delinquents, indeed, seem relatively obtuse of physical pain;<sup>66</sup> for them, as for the idiot described by Galton, pain would come, if ever, as "a welcome surprise." But to the child inured to wretchedness and benumbed by

---

save the boy from a conviction. The father hesitated, but at last agreed. After the birching, the boy returned to the court with the same jaunty air as before, and the police officer privately reported that the father had scarcely touched him. The pair were sent out for another attempt. This time the man came back with his head high in the air, and the boy followed crestfallen. From that time forward there was no recurrence of misconduct.

<sup>64</sup> Montesquieu, *De l'Esprit des Loix*, VI, xii.

<sup>65</sup> The two measures might occasionally be employed together; to sentence a boy to a birching should not necessarily prevent or put an end to the advantages of probation.

<sup>66</sup> See below, Table XV; also Havelock Ellis, *loc. cit.*, pp. 123 *et seq.* Statements and statistics showing the insensibility of the criminal are to be received with caution. Sensibility to pain is exceedingly difficult to test; the most striking cases of its apparent absence are found among the mentally deficient.

suffering, added hurt is only added injury. Hence if whipping is to be preserved as an official punishment, the proper subject of it is not the street urchin from a struggling home, hardened perhaps already by a succession of thrashings far more drastic than a humane legislature will allow, but rather the over-indulged youth whose home is comfortable and easy-going, who has been brought up under a lax and lenient discipline, and who needs the smart tonic of a little pain to pull him sharply up after one or two weak lapses. Yet, when all is said, in ninety-nine cases out of a hundred, corporal punishment, however inflicted, is likely to make the incipient transgressor, not more penitent, but more furtive and defiant, and impunity would do less harm.<sup>67</sup>

##### 5. Improvement of Social Conditions in the Home

In most cases—certainly in every one where the offenses are not isolated slips but recurrent attempts—no single or sudden measure will be enough. As a rule, what is needed most is not simply to whip the child or to send him away, nor yet to punish or subsidize the parent, but to carry out a prolonged and closer study of the entire home circumstances, and to undertake a more careful readjustment of the family situation as a whole. As we shall see later on, many outbreaks of juvenile crime arise ultimately out of the emotional relations subsisting between the child himself and the various members of his family. The real difficulty resides not so much in the external and obvious defects of the home—poverty, unemployment, neglect, weak discipline—as in the inner, complicated tangle of habits, attitudes, and reactions, that have grown up in the minds of the more active inmates. Nearly every tragedy of crime is in its origin a drama of domestic life; and each actor in the plot must be studied individually and sympathetically from his own particular standpoint. Often by a little tactful

---

<sup>67</sup> The reader will find that my remarks have been greatly influenced by the admirable and dispassionate discussion of the matter in Mr. Clarke Hall's book, *The State and the Child* (pp. 23-31). As a rule, most pronouncements on this much debated issue are too plainly biased by *a priori* principles instead of being based upon a first-hand experience of practical requirements and practical results.

discussion the different members—father, mother, brothers, and sisters—can be brought at length to realize the part that they themselves have severally played in the evolution of the final crisis; and may prove willing to modify, under expert guidance, any practices or inclinations that may be tending to break up the life of the family.

At present, in dealing intensively with such domestic situations, social work is somewhat backward; we are too timid of intruding on the privacies of another man's home. The officer at the court often sees no one but the child himself. The officer of the care committee is often forced to visit the home when no one but the mother is in. The untrained social worker, whose reports are in some towns all that can be had, looks usually at nothing but the outer aspect—the cleanliness, tidiness, and healthiness of the rooms and their inhabitants; the subtler influences of personnel remain unnoticed. Of the various relief agencies each is concerned only with its own special case or its own immediate problem as it comes along: and their work is at present so cut up and subdivided that all are obliged to trust in a sort of rapid-fire, hit-or-miss mode of treatment. There is no collation of data, no survey of the situation as a complex unity from every side at once, no general conference in which social, medical, educational, and financial helpers all meet together and pool their several suggestions. Time after time the one individual who is the real center of the problem—the father, perhaps, or an older brother who wields a bad influence, or a low companion who lives next door but is at work during the day—is seen and sized up by no one.<sup>68</sup>

---

<sup>68</sup> In London, it is true, social work is becoming more and more thoroughly organized, and, as will be manifest throughout this volume, all who have there to deal with problems of delinquency are deeply indebted for invaluable assistance to the officers and organizers of children's care. But London regards itself as an exception.

On the general methods of social investigation the reader may usefully refer to the volume by Mary E. Richmond on *Social Diagnosis* (New York, Russell Sage Foundation, 1917). Of the emotional interactions between the older and the younger generation, a brilliant account will be found in Bernard Shaw's *Treatise on Parents and Children*, published as the preface to *Misalliance* (1922)—a "treatise" which is bound to stimulate and be suggestive, even where it does not convince.



After a fuller investigation has been made, it may sometimes appear that the alleged offender is after all the most normal member of his group, and that his apparent offense is in reality a perfectly natural and intelligible reaction to the position that has sprung up. Very commonly the child's own relatives do not understand him; and, indeed, may have barely realized that there is any particular need for understanding him at all. They assume that any normal child should fit neatly into their own scheme of life; should he fail, they take his failure as a cruel misfortune or as a piece of base ingratitude, not as a challenge to reëxamine and to readjust their mutual relations. Till they have been shown, the most well meaning parents may have no conception of what they themselves can do. Again and again in their simplicity they allow situations to arise that can only strengthen and harden the very habits they complain of. How to earn their own child's confidence, how to close down all avenues to temptation, how to create a life at home which shall be more attractive than the paths of vice, this is beyond their unassisted wisdom.

In such a case a direct interview between the psychological examiner and the parent or senior member of the family may be of the utmost help. When this has been arranged, often before any definite explanation has been given to her, the mother, who has watched the child being tested and questioned, will exclaim, quite spontaneously, that she had never before appreciated the child's special weaknesses, special peculiarities, or personal point of view. The psychologist, however, limited as he usually is to one or two short conferences, can seldom do all that is required. To offer two or three words of abstract advice, to enunciate a few generalized maxims on household government, will be of little avail; more likely it will be resented. The instruction must be an instruction through concrete suggestions, as each new problem emerges; it will work better by example than by precept. Tell the mother outright that her boy wants sympathy, generosity, and fuller opportunities for amusement; and she will at once retort that he has all he can possibly deserve or expect. Quietly invite him to a tea party or the Zoo, speak to him with studied gentleness and

courtesy, reward him with a penny or two when occasion affords, and she will probably be the first to emulate your own benevolent methods, and perhaps become wholesomely jealous lest you win greater trust and devotion than she herself has hitherto inspired.

Further supervision can be arranged by asking the parent to see the teacher regularly at the school or, better still, by asking a visitor from the school care committee to call periodically at the home to give counsel and aid. After the offender has himself left school, the school care committee can still keep in touch with him if, as is usually the case, there is a younger member of the family now in attendance. But with older delinquents, who have already passed through the court, the person supervising will generally be the probation officer. When the probation officer is herself too busy to spend the requisite amount of time upon the case, she can usually delegate these friendly offices to some voluntary worker connected with a local club or church. But constant visits and leisurely talks, both with the offender and with his parents, are indispensable, if the confidence and goodwill of all concerned are gradually to be gained. Visiting the family at first almost daily, a kindly adviser, with an official standing and a wide experience, will thus be able to join in the domestic councils. She will be ready with acceptable proposals, and will do her best to see them carried into effect, leaving the general principles to take shape slowly by themselves. She will supply, as it were, a simple tutorial course on family management, not by theoretical lecturing, but by practical demonstrations and coöperative help. When at last the leading members have grasped the underlying axioms of their own accord, then probably they will be able to cope with the situation without further assistance and without any occasion for grim and rigorous proceedings.

## CHAPTER IV

### ENVIRONMENTAL CONDITIONS OUTSIDE THE HOME

Φθείρουσιν ἦθη χρῆσθ' ὀμιλῆαι κακά

Evil companionships corrupt good morals.

MENANDER<sup>1</sup>

THE study of the child's environment does not end with the study of his home. Already, in reviewing the local prevalence of youthful crime, we have seen reason to infer that the character of the street and neighborhood in which the child lives may be quite as significant as the conditions inside his house or lodging. Influences that affect him beyond the circle of his family life may at times be the sole factors in his delinquency. As a rule, such influences are harder to ascertain, more frequently overlooked, yet often in the end the easier to cope with. They fall into three main groups: first, those connected with the child's daily work, whether at school or at business; secondly, those connected with his leisure hours; and, thirdly, those exercised by the companions he meets and the friends he forms, whether schoolfellows, workfellows, or playfellows. Of the three, the last are the most powerful and are the first to need consideration.

#### 1. Companionships

##### *Companions of the Same Age*

Direct Influence.—Of all the explanations offered to the investigator for the wrongdoing of a particular child, the commonest is the influence of bad companions. This, naturally, is the preferred suggestion of the pained and anxious parent: each boy's mother blames some other mother's son. It is an excuse which, just because its working seems so clear and so

---

<sup>1</sup> *Thais*, quoted by St. Paul, I Cor. xv:33.

intelligible, should never be too hastily accepted as the sole and self-sufficient reason for an offense.

The friendships that most commonly exert a harmful influence are friendships with others of the same age and sex as the child himself, living outside the child's own home, but coming often from the same school and the same street, and either actively engaged in delinquency themselves or else actively inciting and encouraging it. As an outstanding factor I have noted such companionships in nearly 18 per cent of my cases—a figure which ranks among the biggest for any single cause (see Table VI).<sup>2</sup> Nevertheless, as a rule, such connections play a minor rather than a major part; and among girls they seem to operate with less force and frequency than among boys. Sometimes, indeed, a boy or a girl, having led hitherto an unblemished career, comes suddenly under the sway of a base acquaintance or of a band of unscrupulous allies; joins them for a while in their mischief; and afterwards, when the malign confederacy has been at length unmasked and the new recruit sent off to a distant district or another school, he settles down there once again to a life of peace and propriety. But a case so simple is an exception. To find an external influence of this kind at work without some inner predisposing factor is far

---

<sup>2</sup> Large as it is, my figure for this factor does not approach the proportions given by Healy. In over one-third of his cases, in so many as 34 per cent, bad companionships were found to be a significant factor; and in over 5 per cent they constituted the main factor. Even including evil associations formed within the home as well as those without and older or adult companions as well as companions of the same age, my percentages would still remain much below these figures. Healy, indeed, writes that "the majority of juvenile delinquents work up their impulses gregariously" (p. 293). I would certainly agree that the majority of my oldest cases, particularly those from the more sordid and more squalid districts, have passed through a gregarious phase; and that this gregarious phase, which usually occurs during adolescence, has done much to intensify mischievous propensities and promote audacious escapades (see below, Chapter IX, under the heading of Herd Instinct). Nevertheless, in at least four cases out of five, as their initial history shows, the criminal impulses have preceded the gregarious collaboration and have, to begin with, been "worked up" in relative isolation. This difference between our findings is, I think, of instructive importance to those who desire to treat the young criminal from the earliest possible stages and to shield him during his later development from the hostile agencies most likely to affect him.

TABLE VI.—ENVIRONMENTAL CONDITIONS OUTSIDE THE HOME

	DELINQUENT					NON-DELINQUENT		
	Boys		Girls		Average	Boys	Girls	Average
	Major Factor	Minor Factor	Major Factor	Minor Factor				
<b>1. Companionships:</b>								
Bad companions of same age.....	3.3	16.3	1.4	13.5	17.7	1.0	—	0.5
Companions of same age not actively bad.....	1.6	7.3	—	5.4	7.6	3.5	2.0	2.7
Bad companionships formed in institutions <sup>1</sup> .....	1.6	2.4	—	4.1	4.0	—	—	—
Molestation <sup>2</sup> .....	—	0.8	1.4	4.1	2.5	—	—	—
Corrupted by adult companions or strangers.....	0.8	—	2.7	1.4	2.0	—	—	—
Indulged by adult companions or strangers.....	—	3.3	—	2.7	3.0	—	0.5	0.2
<b>2. Conditions of Leisure:</b>								
Excessive local facilities for amusement	2.4	7.3	—	9.5	10.6	10.5	12.0	11.2
Deficient local facilities for amusement	—	4.1	—	1.4	3.0	4.0	4.5	4.2
<b>3. Conditions of Work:</b>								
Uncongenial school.....	0.8	4.1	—	2.7	4.1	0.5	—	0.2
Uncongenial employment.....	—	4.9	—	2.7	4.1	1.5	—	0.7
Unemployed.....	—	6.5	—	2.7	5.1	1.0	0.5	0.7
Total.....	10.5	57.0	5.5	50.2	63.7	22.0	19.5	20.7

<sup>1</sup> Institution here includes any home or place of residence away from the child's own parents or normal guardian.

<sup>2</sup> Sexual: by persons outside the home.

from usual; it is as rare as a seed sprouting on bare rock with no receptive soil to nourish it. Against contagion of whatever sort, the strong mind, like the healthy body, is generally immune. The very fact that a good boy is surrendering to the lead of a bad one is in itself a psychological phenomenon; it implies a peculiarity of mind that in turn requires explanation and calls for closer scrutiny. Perhaps his home is dull, unsympathetic, or distasteful. Perhaps the child himself is strongly gregarious by nature. Possibly he is inferior in mentality or physique, in age, character, or will. Possibly some



forbidding feature in his ways, his looks, his history, debars him from all friendship with his normal fellows, and is driving him, a social exile, to mix with outcasts long ago lost to shame. In cases such as these, it will never be sufficient to free the complaint victim from the evil partnership of the moment, and then to do no more. The personal disadvantages, the accessory factors, whatever they are, that have left him such an easy prey to the vicious must likewise receive attention and, so far as possible, be removed.

*Indirect Influence.*—So far, however, I have touched only on the direct domination of accomplices who are definitely bad; it is a process too obvious and familiar to want exemplification. But without being actual wrongdoers themselves, a child's associates may still be a detrimental weight upon his life, the pressure being exercised more or less innocently and indirectly. I have noticed such a process in nearly 8 per cent of my cases. The commonest example is that of the poor man's child, thrown, by the jostling of his lot, among the first-class passengers upon life's journey. His wealthier neighbors all unwittingly, perhaps through their mere presence at his side, entice him to live by dishonest means up to their prodigal style and standard. Of this passive and guileless encouragement I may relate one salient instance.

Edith D. was a sharp, attractive girl, an only child, from a home thrifty, quiet, and humble, but by no means comfortable. Tall and talkative, with dark brown hair and dark brown eyes and a fresh and crimson complexion, she had the unusually high mental ratio of 127.<sup>3</sup> She was, in fact, a pupil of secondary

---

<sup>3</sup> *Age:* 13½. *Home Circumstances:* Father (aged 59), a coke-loader at a gas-works, earning what were then good wages (54s. per week), but working in alternate shifts during the day and during the late evening and night. He is somewhat morose and narrow, showing little understanding—indeed, little desire to seek an understanding—of Edith's very dissimilar nature and outlook. The mother (aged 51) is a large, slow, negative woman, seeming dull and indifferent in conversation, but evidently efficient in the routine work of the house. Two rooms, neat and clean, rent 10s. per week.

There is little opportunity for social life at home. Both father and mother are too elderly to associate on equal terms with the girl. For long, neither of them had thought of asking where the child was getting

school ability, although working in an ordinary elementary school. The school she attended received children of two contrasted types. Like many other in suburban London, it faced a select residential neighborhood and backed upon a slum. Up to the age of ten, Edith had been a lively but obedient child, a little too ready to bespeak the notice of her betters and to impress her equals with unusual powers but popular with the girls and a favorite with her teachers. She had always been inclined towards the company of boys and showed a preference for games played most conveniently in trousers. All this, however, was put down to the harmless animation of one who was "a tom-boy born."

At the age of ten, owing to her exceptional gifts, she was promoted to a high class, a class composed, as it happened, almost entirely of clever girls from well-to-do homes; they were, nearly all of them, a picked group of children, likely to pass very shortly either as scholars or as fee-paying pupils to the

---

the money from for her purchases of sweets and finery. They willingly consented, however, to all the proposals put forward from time to time on the girl's behalf.

*Family History:* The father suffers from *diabetes mellitus* and, like many such sufferers, is of a somewhat neurotic constitution. He states that his mother was a Jewess; and that two members of her family had died early of this disease. The tendency is of some interest in relation to Edith's craving for sweets and a sugary diet. A paternal aunt is said to be excitable and alcoholic. Mother, and mother's family, healthy, but far from bright.

*Physical History and Condition:* Measles and scarlet fever. Now healthy and strong. Analysis of urine negative. She looks older than her years. Height, 155 cm. (nearly that of a girl of 15); weight, 39.3 kg. (about that of a girl of 14). Menstruated at 12<sup>1</sup>/<sub>2</sub>.

*Intelligence and School Attainments:* Mental age (with group tests), 17.0. Reading, 16.0. Spelling, 16.0. Composition, 17.0. Arithmetic, 15.5. Handwriting, 15.0. Drawing, 16.0. Handwork, 14.5. During the tests she showed signs of an imaginative and talkative disposition. Her mental reactions were quick, but for a girl of her high intelligence she was curiously uncritical of her own performances and at times rather easily distracted.

*Temperament:* Somewhat unstable and unrepressed; history of slight neurotic tendencies in the past (walking and talking in her sleep). In her reading she shows a marked preference for stories of adventure and books for boys. Her favorite films are social dramas; and her favorite actress "Pearl White, dressed like a man, doing stunts on horse-back."

secondary school. Edith just missed her scholarship. Among a little clique of duller children left behind like herself, she quickly took the lead: she had failed to earn a triumph by scholastic success; and now became desperately desirous to make as fine a show as they did in matters of dress, pocket money, and out-of-school amusement. What the others had without asking from their richer parents, Edith was driven to get by subterfuge; and her natural astuteness soon taught her to pilfer without discovery or suspicion and with increasing profit and success. She first took a pair of gloves and several lace handkerchiefs—all the property of other girls; then boxes of sweetmeats and confectionery from shops—dividing the contents with her unsuspecting friends; and finally half-crowns and ten-shilling notes from home—spending the money, for the most part, on cheap brooches and bangles, and on various forms of childish recreation.

Detected at last by her mother, she for a while suspended her stealing. But she possessed neither the conventions nor yet the home control which kept the meeker members of her set within the prim limits of respectable propriety. As she grew older, she sought to gain their awe and admiration by the highly painted stories she could tell of her dashing adventures in the evenings—the dances, the music halls, the champagne suppers (to which, by her account, she had been taken by different male adorers), the revels she had shared, the risks she had run: one night she had been “nearly drugged in a private room”; on another she had been “kidnaped by a motorcyclist” and had to jump from the side car while traveling at full speed; a few weeks later she had been “almost arrested,” apparently for hilarious merriment after consuming in swift succession “cherry brandy, tawny port, and a lovely green liquor.” She was, indeed, in a fair way to become the feminine counterpart of the immortal youth in *The Spectator*, “of lively parts and of a sprightly turn in conversation,” who “wished before all things to establish the reputation of being a most agreeable rake,” and who “contrived now and then to get knocked down by a constable, just to signalize his vivacity.”

The confessions that she poured out to her credulous audi-

ence were not without some spice of truth. An older ex-pupil had found it a convenience to enlist Edith as a sort of youthful chaperon and had taken her to several inoffensive entertainments in company with her "young man" and his younger brother. All three of them were entirely proper, if somewhat flippant, companions. But since the "young man" was disinclined to pay for more than two, Edith had resumed her skillful thieving to defray the expenses of the younger brother and herself. Their regular diversion was the cinema; and it was from the pictures of high life that Edith got local color for her own embellished escapades. These things went on for a couple of years. At length distorted rumors reached the ear of another child's parent, and his protest led to an inquiry into Edith's evening occupations. She was sent to me on suspicion of sexual misbehavior, and though this particular charge proved groundless, the rest of her misdoings were speedily brought to light.

To ask Edith to throw over her old admirers was obviously unfair. They had been innocent: all the guilt was hers. It was only in a passive, indirect, and wholly unintentional fashion that they had abetted her fictions and her thefts. I thought it best to lift no finger to keep her double character a secret. Horrified at the disclosure, shocked by the deceit and dishonesty of one whose free-spoken candor had seemed her outstanding charm, all her friends, male and female, young and old, severed their connection. She was "sent to Coventry" and a few weeks' boycotting was not without its benefit. At the close of the term an opportunity arose to transfer her to a neighboring central school, an institution attended by children of her own ability and of the same economic class. In such a circle a different tone prevailed: to display finery and to boast of social feats was to court derision more than popularity; and Edith, whose one aim was to emulate others in their own chosen line, whether good, bad, or commonplace, started vying with her classmates, no longer in extravagance, but in scholastic work and athletic sports. She presently became a prefect in her new school and a leader at an evening club for girls, and when she left, was recommended for a junior but well-paid post as a clerk in the city. Every subsequent report has been beyond reproach.

The effect upon the poor but facile lad of contact day by day with rich and frivolous associates has been a well-worn theme among moralists and novelists. And though these popular descriptions err by over-simplifying, and depict the mental processes at work as more direct, and less intricate and subtle, than is commonly the fact, they save the need for further illustration.

### Adult Companions

The evil influence of adult acquaintances is much more unusual than that of childish comrades. The latter I have observed in 25 per cent of my cases; the former, in only 5.

Outside the home the persuasions of a grown-up friend may be at times deliberately pernicious. Girls suffer most. A presentable maid from the provinces, tired of domestic service, can find all too easily an older woman who will initiate her into various malpractices, who will point out West End streets or Soho restaurants safe for such uses, who will tell her (with much inexactitude) how to avoid the three great plagues of an irregular life and from what shops and markets she can most safely pilfer when "business is bad"; and such a woman, after a little initial liberality—the loan of a fur or the offer of smart shoes—will look more or less openly for some material return. But among youths and boys I have found no similar instance of cold and calculated training—no adult professional tutors in theft or burglary as a trade. The schools for young house-breakers, pickpockets, and thieves, with a Fagin in charge, a Bill Sikes as his chief assistant, and country immigrants and kidnaped orphans as the weak intimidated pupils, no longer exist outside the pages of fiction. I have, indeed, met receivers of stolen goods who habitually accept looted articles from boys and girls no more than ten years old, and who sometimes furnish the more regular traffickers with useful hints as to methods and means. But direct instigation of this sort is rare and is probably offered to none who are not seasoned little thieves already.

The commonest examples of demoralization by adults are of a vaguer and more general nature. Usually it is some older youth or man who wields an ascendancy over some young and



adolescent girl. In such cases there is almost always, either openly or covertly, a sexual emotion at work; it issues, as a rule, in the formation of a so-called sexual complex, though frequently the resulting offenses are not themselves sexual. From time to time a definite story of sexual molestation is disclosed; and the effects, as we shall find later on, may be various and far-reaching. Nor is the corrupter invariably of the opposite sex. Homosexual attractions are occasionally encountered, usually among males, more rarely among females.

More often than not the power of the adult is exerted with the purest of intentions. The older man—sometimes a casual acquaintance, sometimes a time-honored friend—has lavishly regaled the appetites of his youthful protégé and has thus awakened in the boy or girl a relish for luxuries and excitements far beyond the child's unaided means. Once set up, the costly habit of thoughtless self-indulgence grows into a craving, and when his benefactor is at hand no longer, the little pleasure seeker is tempted still to gratify the same desires by the short and easy methods of dishonesty. The misguided charity begins often at home. Every one knows how the good-looking girl is first petted and spoiled by kindly uncles and by munificent friends of the family, and soon, quite pardonably, begins to cultivate a coy appealing look for every visitor—a silent glance that begs, always in the most winsome and irreproachable way, for sweets, for a silver coin, or for an invitation to the pantomime or the pictures. She grows older, and the same feminine arts can be practiced with success on the moneyed youths of the neighborhood. And from thence it is no long step to soliciting, with dumb demureness, the passing stranger in the street.

The mercenary ways of the spoilt and pretty girl are a by-word. That similar motives may come to operate in the minds of tinier infants, boys no less than girls, is a truth equally well founded if more often overlooked. The following is typical of a multitude of junior cases.

Johnny E. is about seven and a half, but he only looks five and a half.<sup>4</sup> He is a diminutive child with a chubby and cherubic

---

<sup>4</sup> *Age:* 7½. *Home Circumstances:* Entirely respectable. Father, a plumber (wages £2 15s. per week). Two rooms (rent 10s. per week).

face; and the first ejaculation of almost every woman that sees him is "What an angel!" Johnny, however, is anything but a little seraph: he approaches far more closely to the unspeakable reverse. At one time he was idolized by all his relatives at home. They praised him; they petted him; they pampered him in every way. But soon, so great were the calls he put upon their patience, that every one in turn grew weary of his company. He was sent to an infants' school, and the same history was repeated. For a day or two he was the special favorite of the class, and for the rest of the time its terror. By those who had to live with him day after day, his selfish temper was rapidly realized; and he soon found that his most profitable line of work was to touch the hearts of strangers. He lived near a fashionable quarter much favored by elderly ladies with large sympathies, full purses, and no children of their own. Their philanthropy was his undoing. He had, to begin with, a dexterous knack of giving every escort the slip whenever he was fetched from school. Some older person had always to be deputed to convoy him safely home; but however tightly his little fist was gripped, he could always produce a convulsive sneeze or a sudden need for a handkerchief, and once his hand was loosened, Johnny was round the corner faster than grown-up legs could follow him. Having scurried away and vanished from sight, he would carefully roll in the mud, untie his bootlaces,

---

Mother formerly went out as a washerwoman, but is now unable to work. One other child, an infant of seven months. When Johnny first came to school, his mother, it was said, had fussed over him like a hen with a single chick. Recently her health and the needs of her baby had prevented her from giving him all the attention he demanded. But these conditions, so far as could be judged, were no more than subsidiary factors.

*Family History:* The paternal grandparents were countryfolk, all said to be normal and healthy. The maternal grandmother and her family (a large one) appear subject to respiratory diseases; the mother herself has had pneumonia twice, and is still far from strong.

*Physical History and Condition:* Subject to bronchial catarrh; health otherwise normal. Height, 103 cm.; weight, 18.3 kg.

*Intelligence and School Attainments:* Mental age, 8.0 (mental ratio 107). Reading, Spelling, and Arithmetic, 6.5 years. Handwriting, Drawing, and Handwork, about 7.0 years.

*Temperament:* Active and unrepressed, but not abnormal for a child of his years.

or perhaps pull off and hide his shoes and stockings altogether, and then sit upon a curbstone piteously whining. It was seldom that many minutes passed before some gracious lady would come up to him, lift him in her arms, wipe away his tears and ask the cause of his heartrending sorrow. According as he judged the probable response, Johnny would then relate how father was penniless or mother cruel, or how he himself had lost his way, or had neither home nor parents to go to. Between many gulps and sobs, pathetic touches would be added, lurid and fantastic enough to raise suspicions as to the veracity of the whole romance; but, after all, an atom who looked only five or six years old could not be expected to be precise in detail; and lips so babyish were obviously incapable of lies. By these and similar tactics Johnny could procure an afternoon of bounteous entertainment such as he never enjoyed at home. Sometimes the kind Samaritan would lodge the young waif in her house for a day or two; and feast and make a fuss of him until an inquiring officer tracked him down; at the very least, he was sure to get toys or sweets or a handful of coppers to spend.

So adroitly, so effectively, had Johnny learnt to play upon a tender heart that, before he was eight years old, he had become a skilled professional mendicant with an ingenious line of exploitation all his own. His tale of the derelict orphan, however, was related once too often. It brought him at last to the place to which lost boys are usually conducted—the police station. Here he was tipped and regaled by the good-natured officers, who gave him the kitten to play with (a tribute to his successful imposture which he afterwards described with gusto), and was retained until telephone inquiries from another station revealed that his true character and his real home circumstances were quite other than had been assumed. The remedy proposed was to send him away for a couple of years to a strict but comfortable institution in the country, where he saw no grown-ups except those who had already been disillusioned, and was thrown into contact with none but healthy-minded boys of his own age and rank. Here he speedily developed to nearly the full dimensions for his years, lost his captivating looks, and

gained a wholesome passion for nature study, woodwork, and football, all of which he was able to follow up when at length he returned to town.

## 2. Conditions of Leisure

### *Excessive Facilities for Amusement*

The temptations of town life are brought before the notice of the growing mind not only by the active agency of other human beings, base, indifferent, or well meaning, whom the child encounters in the crowded streets, but also by the passive solicitations to pleasure and excitement which a vast metropolis like London parades at every turn. Thus the material as well as the human influences of the child's environment must be included in the account.

In studying our map of juvenile crime we noted that, while the points of highest incidence lay in the slums that border on the busy quarters, certain smaller patches of secondary importance were to be found in or around what may be termed the entertainment districts. Prince Florizel, it will be remembered, when his friends were seeking a base for their adventures, held that "the strategic center of the universe was planted at the heart of the city of encounters, the Bagdad of the West—or, to be precise, in Rupert Street, Soho."<sup>5</sup> And on my larger map, where I have marked down streets instead of boroughs, here or hereabouts is certainly the liveliest spot. The area is small; but it stretches north as well as south of the eastern extremity of Oxford Street and finds its geographical and moral focus centered, a stone's throw from Prince Florizel's "Divan," in what is known to Londoners as Berwick Market. It is a strange collocation of streets of many types, where in the main thoroughfares almost every other building is a candy shop, a restaurant, a cinema, or a theater, and in the side alleys the scum of West End life collects—hawkers, loafers, beggars, and drunkards, the hangers-on and the pickers-up of every type who snatch a precarious living from the careless pleasure-seeking crowd that troops into the district towards nightfall. The lights, the illumi-

---

<sup>5</sup> R. L. Stevenson, *The Dynamiter*, "Prologue," p. 3.

nated signs, and the gay shop windows of a brighter London glitter seductively before the youthful eye. Even if you do not live in the locality itself, here is the most stirring scene to make for when playing truant or spending a late evening out. The stalls and barrows in the market are said to be the easiest to steal from, and it is not difficult to engage in a little street trading of your own. If you are small, you can, with a saucepan for a drum and a couple of your mother's spoons to rattle on your elbows and your knees, make as much as five shillings in less than half an hour by entertaining the standing queues of theatergoers. If you are older and adolescent, you can watch the dodges of the pickpockets, the cab openers, the flagstone artists, and the painted women of the pavement, and perhaps, according to your taste and sex, copy their methods to no small advantage when sorely put to it for funds yourself.

I recollect one evening, several years ago, taking home a young lady of eight.<sup>6</sup> She passed grave comments, with all the

---

<sup>6</sup> *Age:* 8½. *Home Circumstances:* Father separated from mother, and since dead. Mother, gentle and refined, formerly a post-office sorter, now an office cleaner (42s. per week). One younger sister of three, apparently normal. One large room, with furniture eloquent of better days (rent 6s. 6d. per week).

*Family History:* Father appears to have been dull and ill educated, often out of work, and somewhat hasty in temper. Paternal uncle, alcoholic. Maternal grandmother, died of general paralysis.

*Physical History and Condition:* Measles, whooping cough, blepharitis (in infancy). Signs of past rickets; slight chronic catarrh; inflammation of throat; tonsils and adenoids recently removed. Voice thin, nasal, and high-pitched. Reflexes normal. Height, 115 cm.; weight, 21 kg.

*Intelligence and School Attainments:* Mental age, 8.5 (mental ratio 103). Reading, 9.0. Spelling, 8.0. Composition, 8.5. Arithmetic, 7.5. Handwriting, Drawing, and Handwork, about 8.5. Geography and History, 9.0. Maisie was evidently much better at informational subjects than at formal; history and geography, with their concrete content, she enjoyed; arithmetic and spelling, with their meaningless rules and their demand for sheer rote memory, she frankly loathed. In choosing her second school this was borne in mind; there interest rather than drill was made the pivot of the teaching and for a time Maisie's truancy ceased.

*Temperament:* Unstable. Slight neurotic tendencies (walking and talking in sleep, with occasional nightmares). At times peevish and irritable; would easily cry, but quickly recover her gayety and composure; sex interests strong and precocious. At home, apart from her thefts, Maisie's conduct was irreproachable; she was an excellent little mother



penetration of a Piccadilly police woman, on the various characters we met; she appreciated, quite as well as I did and rather to my consternation, how these various types were getting money for their pleasure. Our way took us past the lower end of Tottenham Court Road. At each of the four picture palaces, we had to stop and study the program for the current week. And it so happened that, the day before, a wonderful new chocolate shop had been opened and was now all ablaze with dazzling steel-blue lights; gaudy boxes of luscious-looking sweets were advertised at only one shilling the pound. Against that window pane, for two whole minutes, Maisie's snubby nose was pressed. When at last I induced her to turn reluctantly away she could not keep back a covetous sigh: "Oo, don't it make your mouth water?" It was not surprising to hear that on the next occasion that she passed that way without an escort, she bought a couple of boxes with two stolen florins (two-shilling piece), and consumed nearly four pounds of chocolates before she reached her doorstep. Her mother, a quiet, respectable widow, was urged to change her rooms. After eighteen months' delay she moved, but only to another street in the same gay quarter, even nearer, in fact, to the cinemas; and the next report deplored that nothing could now keep Maisie from the picture palaces and that she was plundering her mother's purse almost every other day to pay for a seat. This time the mother was prevailed upon to seek a tamer neighborhood in a distant suburb, and for the space of nearly three years Maisie was comparatively staid and well behaved. Then, after an imprudent visit of mother and child to a friend near Leicester Square, Maisie began once more to frequent the old resorts alone, and during her final term at school she was playing truant three or four times a week. The West End drew her like a magnet and soon held her like a clutch. Now, at the age of

---

to her smaller sister; young as she was, she made a useful cook and housewife; when her mother was ill, she bought the food and prepared her mother's simple meals. Parlor games and indoor amusements she had no taste for. She took a pride in her knowledge of the topography of her neighborhood; loved to direct people to the streets or houses they might be seeking; and had a remarkable memory for the contents of local shop windows and the playbills of the theaters.

seventeen, she is living in a Bloomsbury flat, with no more than a nominal occupation, a chorus girl in the winter, a waitress in the summer—and a dishonest waitress at that, but most of the time idle and unemployed, spending on cheap dissipation what she earns by systematic vice.

The Cinema.—One feature among the attractions of every town and suburb—a feature already mentioned more than once—demands discussion at some length. The cinema, like the “penny dreadful” before the advent of the film, has been freely censured and abused for stimulating the young adventurer to mischief, folly, and even crime. Among those who criticize it on this ground, the most credible are teachers of wide experience and magistrates of high standing; but perhaps none is so eager to advocate this view as the young culprit himself, who frequently sees, or thinks he sees, in such a derivation of his deeds a chance to deflect blame and attention from his own moral laxity to that of the producer of films.<sup>7</sup>

I have noted an excessive passion for the cinema among over 7 per cent of my delinquent boys—the child visiting the cinema on an average two or more times a week. In a few rare cases I have had to rank it as the principal cause of crime. An equal passion appears more seldom among the girls, namely, among only 1.4 per cent—these, unlike the male habitués, being all above school age.<sup>8</sup>

The power of the pictures is harmfully exerted in three ways, two of which are, to my mind, exceptional and usually overstated, while the third is at once the most serious and the most subtle, but seldom explicitly remarked.

(It is alleged, in the first place, that what is called his “faculty of imitiveness” renders the child peculiarly prone to copy whatever he witnesses upon the screen. “Crook films,” it is said, are as popular as detective novelettes; the topic of crime

<sup>7</sup> Four years ago I overheard this dialogue at a remand home. *New-comer* (due at court on the following day): “Oo’s the ‘beak’ tomor-rer?” *Veteran*: “Old W. . . .” *N.*: “What d’yer s’y to ‘im?” *V.*: “S’y it’s the pitchers; ‘e always makes a speech about it and nods at yer for ‘provin’ ‘is p’int.” So shrewdly do these young rascals plume themselves upon an insight into their elders and their judges.

<sup>8</sup> See below, Table XIX.

has a special appeal to the young imagination; and if a boy or a girl has seen a representation of a cracksman breaking into a house, or a hooligan battering the police, or an adventuress proffering her love as the price of giddy pleasure, then, it is supposed, the child may be irresistibly inspired to reënact in real life the fictitious example set before him. But how far, in point of fact, are children influenced in this way? On shifting the evidence adduced by those who express these fears, it is plain that both their inferences and their psychological assumptions are by no means free from fallacy. Nor are their facts better founded. They have between them hardly one well-attested instance from their own first-hand knowledge, hardly a single analyzed case to put forward in proof. That certain children at certain ages are highly suggestible and imitative, I am far from wishing to dispute; and beyond doubt the peculiar conditions of cinematographic reproduction heightens this natural susceptibility still further by artificial means. The darkened hall, the atmosphere of crowd excitement, the concrete vividness of visual presentation, the added realism due to movement and to the play of facial change, and above everything the intensely sensational character of the emotional scenes portrayed—all are calculated to increase the child's suggestibility and to stamp upon the impressionable mind graphic images and lasting recollections. Mental pictures, so deeply imprinted, may sometimes issue in obsessions haunting and irrepressible—recurrent thoughts and impulses bound from their very persistence and strength to work themselves out by action. All this is not to be denied. Yet, of the ensuing acts, how much is crime? Most of the characters and situations rehearsed by film-smitten children are as innocent as those of any other piece of childish make-believe. Who has not seen street urchins mimicking Charlie Chaplin, "holding" each other "up" with toy pistols, or masquerading in the feathers of Red Indians or the wide-awake hats of cowboys, every flaunted detail manifestly picked from the romances of the film? Even where the model is a heroic pirate or bandit chief—an Arsène Lupin or a Long John Silver—the adventures themselves may be as innocuous as those of Tom Sawyer or Huckleberry Finn. The direct reproduction of

serious film crimes is in my experience exceedingly uncommon, and even then it is usually the criminal's method rather than the criminal's aim that is borrowed; the nefarious impulses themselves have been demonstrably in existence beforehand.

Four or five authentic instances I have, indeed, encountered, where a crime seemed directly inspired by the cinema, but they have been confined almost exclusively to the dull or the defective. A girl of eleven with a mental age of seven took a key from her teacher's purse, unlocked a draw containing subscriptions to a shoe club, and stole three treasury notes, leaving the copper and the silver untouched; what she had taken she then hid, first in her stocking, and afterwards in the lining of her hat. She seemed too stupid to have hit upon these devices by her own unaided wits, and asked how she came to think of so deliberate a plan, she at once replied that she had "seen a lady doing it on the pictures." I was able to verify that an almost identical exploit—the unlocking of a drawer by a mythical girl thief and the concealing of paper money in these two successive hiding places—had been exhibited at the picture palace named; and that the child herself had in fact attended on a day when this film was on the program. In two points at least, however, this case was unusual. An actual theft is generally the rarest of exploits to be imitated from the pictures; and, as a rule, the imitative culprit is not a girl but a boy.

One night a defective lad, an agile youth of fifteen with a mental age of ten, climbed burglariously through a window into a neighbor's house, wearing a stocking over his face. He produced and lit a candle, arousing an old lady who was sleeping in the room; then, alarmed by her calls, he fled precipitately by the way he had got in. The woman rightly thought she recognized the figure of the boy, but every one who knew him insisted that she must have been deceived; he was far too dull and witless, they urged, to concoct a scheme so elaborate, and had never before been detected in any disreputable deed. Unluckily the youthful housebreaker had dropped his candle before he fled. It showed, on opposite sides, dents and bitten marks that could scarcely be mistaken. Accordingly, before accusing the boy I visited the special school that he attended and procured from

every pupil in the top class wax impressions of their teeth—no very disturbing procedure, had its private purpose failed, for the psychologist is known to be interested in dental deformities of the defectives. A comparison of the indentations on the molds and on the candle at once confirmed the old lady's belief. Thus confronted, the boy made a clean breast of it. He had seen that very evening a similar burglary depicted on the screen; the villain of the piece had made a mask out of a sock, and while forcing open the window with his hands, had held his electric torch between his teeth. His youthful imitator had no flash lamp; so he carried a candle instead, which thus so treacherously betrayed him.

Three other instances I have upon my records, less circumstantial and less conclusive, where the maneuvers of film crooks seem to have imparted to a dull and backward lad some particular device he has used. But these few cases are the only ones that I have been able to verify in the course of a long and scrupulous search.

Where the method used is not so far-fetched, and where the ingenuity of the perpetrator is of a higher level, it is obviously hard to ascertain how far the ruse employed has been genuinely suggested by a demonstration on the screen. No doubt, what sometimes happens in the defective mind, occurs also—though overlaid by the subtler workings of a more complex intelligence—in a mind that is normal. But when all is said I am convinced, from a careful sifting of each conceivable case, that direct imitation is exceptional and rare. And, moreover, of recent years the exhibition of criminal methods has been almost entirely excluded from films shown in the public halls.

2 The second charge against the cinema is easier to substantiate. The cinema, it is said, provides a standing temptation to steal money for admittance. No doubt, after the confectioner's shop, the place where pilfered pennies are most frequently spent is the pay box of the picture house. But because they are spent at a cinema, once they have been stolen, it does not follow that they were stolen with that purpose consciously in view. The temptation may have come simply from seeing the coins lying handy; and the mode of disposal may have been no more than



an after-thought. Further, the temperament of the typical thief is just the temperament to which the sensations of the picture house appeal most strongly; he comes from just the dreary, comfortless home which makes the cinema almost his sole means for mirth and amusement; hence the union of the two habits—the habit of stealing and the habit of picturegoing—a coincidence rightly observed to be significantly frequent, is not so much a matter of effect and cause; it is the double by-product of a deeper common source: the underlying adventurous nature of the child, for which his humdrum life affords no satisfying outlet, animates and penetrates them both. The attraction of the cinema, therefore, can be counted as a direct incentive, only where the child has acquired an overpowering habit, an inveterate taste and craving, for that particular form of diversion.<sup>9</sup>

It is chiefly among boys that the picture craze and the cinema habit rise to this inordinate pitch. The commonest and most excusable instances occur when the child has been following week by week some absorbing film in serial form, and, money or no money, his eagerness to finish the concluding episodes is a passion too strong to overcome. But the most singular instance that I have met with was reported to me by a trustworthy investigator in the North. Half a dozen devotees of the cinema combined themselves into a juvenile mendicant club. Evening after evening they hid their boots and stockings, separated, and patrolled the streets barefoot, begging for coppers, to be spent afterwards in company at the pictures. One day a member of the band stole the hidden footwear of his companions and pawned it all, purchasing—though at the price of solitude—toffee and tangerines in addition to the usual entertainment. So the club came abruptly to an end.

The main source of harm, however, has been as yet unmentioned. It is in the general and more elusive influences that the real danger of the cinema lies. Throughout the usual picture palace program, the moral atmosphere presented is an atmosphere of thoughtless frivolity and fun, relieved only by some sudden storm of passion with occasional splashes of senti-

---

<sup>9</sup> On the full-grown passion for the picture palace, I shall have more to say under the heading of interests and sentiments (see Chapter XII).

ment. Deceit, flirtation, and jealousy, unscrupulous intrigue and reckless assault, a round of unceasing excitement and the extremes of wild emotionalism, are depicted as the normal characteristics of the everyday conduct of adults. The child, with no background of experience by which to correct the picture, frames a notion, altogether distorted, of social life and manners. The villain or the vampire, though outwitted in the end, has nevertheless to be portrayed with a halo of fictitious glamour or interest would flag: he does wrong things, but he does them in a smart way, with daring, gallantry, and wit. It is true that, in most of the plays, the scoundrel is infallibly unmasked and eventually requited. But the hollow and factitious character of this pseudo-poetic justice seldom deludes the most youthful spectator. Simply to attach a negative to an impressive or alluring thought is not to arrest its tendency to action, except among persons supremely rational and self-controlled. Say to an enterprising but guileless child, "Thou shalt not gamble," and the mental picture that becomes effective is the new idea of "gambling" conveyed as a temptation of fascinating danger, while the well-worn "not" remains the merest abstract particle which cannot even be visualized. Far better is it that notions and images of vice should never be placed before his eyes at all.

But quite apart from the definite presentation of wrongdoing, the social dramas and the pictures of high life, with a force as subtle as it is cumulative, stir the curiosity, heat the imagination, and work upon the fantasies of boys and girls of every age. They provide models and materials for all-engrossing day-dreams; and create a yearning for a life of gayety—a craze for fun, frolic, and adventure, for personal admiration and for extravagant self-display—to a degree that is usually unwholesome and almost invariably unwise. It is, most of all, in its treatment of the social relations between the opposite sexes that the effects of the film are most injurious. For a photoplay a "love interest," in one form or another, is as indispensable as it is for the cheap romance and the popular melodrama. Theater-going and novel reading, however, are by no means so widespread among young children as is the habit of visiting the cinema. Further, in the moving picture, the intimate details of

courtship, coquetry, and married life are given in ocular demonstration with far more vividness, particularity, and repetition than could possibly be provided in the printed book or on the stage. All who have worked with juvenile delinquents must have realized how stimulating such exhibitions are to the sexual instincts and interests, not only among adolescents, but also, prematurely and precociously, among quite young boys and girls. Nor are the ultimate effects confined to habits, thoughts, and vices of a specifically sexual character. Here, once more, direct and immediate imitation is the rarer outcome. More frequently there is first of all a furtive perplexity and mental conflict; then an intolerance of the strain; and finally a burst of violence or adventure, which on the surface may have nothing whatever to do with sex, but is calculated to relieve the deeper tension, and to drown the hidden promptings, by some wave of desperation, more turbulent perhaps, but less ruinous and degrading.

When all is said, however, it is easy to overblame the cinema, to exaggerate the actual harm and ignore the possible good. It is clear that in comparison with the incalculable number of films that are manufactured and released, the offenses resulting are infinitesimally few. The victims are almost wholly those who, temperamentally or otherwise, are already disposed to antisocial conduct; and the cinema can do little more than feed and fan the latent spark. Fortunately those who are susceptible to the more demoralizing points are scarce; and when their proclivities are known, it should be possible for the teacher or parent to keep them from all but the more decorous, artistic, and educational productions. For the others—the steady and the healthy minded—the picture house supplies an alternative, not a provocative, to mischievous amusement. I could, I think, cite more than one credible instance where the opening of a picture palace had reduced hooliganism among boys, withdrawn young men from the public house and supplied the girls with a safer substitute for lounging with their friends in the alleys or the parks.<sup>10</sup>

---

<sup>10</sup> A great deal of suggestive evidence—some of it, it is true, ill-founded and conflicting in character—will be found in the *Report of the Cinema Commission, 1917* (pp. xxxiv-xlvi, and references in footnotes). A recent and suggestive article is that by T. W. Trought, J.P., on "The Cinema and Child Welfare," *Report of the Second Annual Session of the*

*Betting and Gambling.*—Of the grosser forms of relaxation to which the young lad takes when the opportunity meets him, one of the most usual is betting and gambling. The frequency of these practices is beyond doubt upon the increase, but varies singularly from place to place. They are commonest in working-class neighborhoods, where there are mews, culs-de-sac, and secluded tenement staircases, in the shadow of which such diversions may be carried on unseen. Certain areas seem infested by street book-makers whose methods for defeating the vigilance of the police are amazingly well organized. In some parts many small shopkeepers—confectioners, stationers, tobacconists, or hairdressers—are known to their customers as book-makers' agents; and their ostensible business is little more than a cloak for a betting office. The influence of such facilities on the youths who live near by is always harmful. Often the tricks are learnt from companions either at work or in the street; but in almost all the poorer districts, and sometimes in the well-to-do, children are freely used as messengers to carry betting slips from their parents to the book-maker, and even to write out for their parents the slip itself.<sup>11</sup>

The extent of such practices among the young is difficult to gauge. In a recent inquiry, made at a London school, it was found that, out of a class of forty-two boys, most of them scarcely eleven years of age, nineteen had regularly backed horses for the bigger races, like the Derby or the Lincolnshire Handicap, and several were in the habit of making bets as many as three or four times each week: young as they were, these habitués were regular purchasers of Hall's "Three-penny Tips," and placed their own bets with the book-maker. Quite tiny boys of eight or nine may be seen in their own backyards playing

---

*International Association for Child Welfare* (Geneva, 1923, pp. 626-44). It is noteworthy that police court missionaries and probation officers do not themselves take the charges against the film drama very gravely; and regard the cinema as more of a deterrent to crime than an incentive. Healy, on the other hand, urges the case against the cinema with stronger force (*loc. cit.*, pp. 306 *et seq.*).

<sup>11</sup> See *Report from the Select Committee on Betting Duty* (1924), p. xxxi; also the evidence of Superintendents of Police, *ibid.*, pp. 299 and 505, and of Miss X., described as an assistant mistress in an L.C.C. school for boys, *ibid.*, pp. 499-501.

pitch-and-toss for halfpennies; and bigger schoolboys can be caught playing for money with cards or dominoes behind some sheltering chimney on their tenement roof. Among girls of school age gambling and betting seem almost unknown. But among older girls and young women such things are not at all infrequent, and may be carried on in some low public house or café, or in the factory or office where they work.

As a violent passion or craze, strong enough to form the chief motive for crime, betting and gambling do not appear with any frequency until after the age limits here observed. But the beginnings of its growth were traceable in half a dozen of my youthful cases when they first came to me; and in two of these, in spite of philanthropic effort, the worst predictions were fulfilled.<sup>12</sup>

As we shall find when we reach a nearer view of this general temperament, the young delinquent is a lover of excitement and owns all the natural qualities of the gambler. Often it is the most intelligent whose minds are fascinated by the petty technique of a wager.<sup>13</sup> The psychology of betting and gambling has never properly been studied. But whatever may be thought of its intrinsic nature, there are four clear ways in which such a practice may become a menace to the working lad's career. First, it fosters in an unhealthy form the craving for excitement that is already native to him: after a few short months he may be unable to conceive any issue of interest in which money is not at stake. Secondly, it implants a demoralizing hope for some short and easy way of earning large sums without the

<sup>12</sup> Since the variations from place to place and from time to time are so large, the figures from my small samples are hardly worth tabulation. Among the delinquent boys above school age, 43 per cent were habitually engaged in gambling or betting; among those still at school, only 8 per cent; among the delinquent girls above school age, only 6 per cent. In these particular groups, however, I found it hard to find a case where such practices could be viewed either as grave delinquencies themselves or as factors in delinquency. In the control group I found no habitual cases among the boys still at school and none among the girls, whether old or young; 22 per cent, however, of the boys over school age, picked as non-delinquents, admitted gambling or betting with some regularity.

<sup>13</sup> See, for an instance in point, the case of the supernormal boy described below, p. 337.



trouble of thinking and working for them. Thirdly, it costs him more than he can afford, for by the simple laws of chance every bettor loses in the long run; and thus there arises a strong temptation to steal or embezzle—new ventures which appeal to the inveterate gamester as little else than another and a bolder mode of speculation. Finally, at every stage, it brings him into touch with degenerate characters and with the surreptitious arts of an illegal trade, and so shakes his moral faith and paves a way to worse transgressions.

*Other Influences.*—Other features that often characterize the neighborhood of the young delinquent's home may be more briefly passed over.

The shopping centers, with their fashionable throngs and alluring displays by day and their twilight processions of animated groups and arm-linked couples promenading beneath the lamps at dusk, form at all times a favorite resort for the idle and unoccupied youth of every class and of either sex. Here many a dangerous friendship, many a costly habit, many a truant day and a late return to home, finds its origin and explanation. How the contents of the shop windows near home or on the way to school may snare the vain or greedy child, how in poorer districts the street markets, with their costers' barrows and stalls piled high with nuts and oranges, may offer chances yet more tempting to light fingers and to nimble feet—all this we have already seen. In London, the huge emporiums of Kensington, Queen's Road, and Oxford Street, where toys for the young and finery for the adolescent are exposed with seeming carelessness on counters and trays, where any visitor of any age may walk in and out and up and down without a question, afford an easy decoy to the covetous: by keeping close, it is said, to some elderly customer, who rather resembles an aunt, a small child can escape suspicion; and the whisper that detectives in disguise are stationed on every floor adds zest rather than fear to the adventure.

To other haunts of the smaller truant we have been already introduced by Jerry. The tube station or, when near at hand, the terminus of a big railway forms for the prowling youngster a regular rendezvous. The engines, the hurrying passengers,

the trainman with his flag and whistle excite the interest and envy of most young boys. The exits and the entrances of the ticket office seem specially arranged for hide-and-seek—in which sometimes a porter or a policeman may join to more serious purpose. At times one can “cadge a copper” for carrying a bag; and it is by no means difficult to beg or pilfer. During the war children of both sexes and of an age incredibly young would not infrequently loiter near the main approaches and offer themselves—or pretend to do so—for illicit purposes to arriving soldiers in return for money or sweets.<sup>14</sup> The slums around the main stations, as we have found, include some of the most criminal quarters of London. In such a neighborhood the sudden opening of a play center or of an evening club, the formation of a patrol of Boy Scouts or of a company of Girl Guides, has, to my knowledge, rescued several small but veteran street beggars and more than one potential thief or prostitute from a professional career of crime.

Of the institutions that are more notorious as common avenues to vice—the public house,<sup>15</sup> the dance hall, the night

---

<sup>14</sup> I owe the reader some apology for my recurrence to topics of this nature. It is to be remembered, however, that among delinquent girls nearly half the offenses are sexual, and a large proportion of the other offenses develop on a sexual basis. He who consents to open a work on such a problem as juvenile crime must be prepared to face the raw particulars with both eyes open. It is as painful as it is creditable to find that many teachers know nothing of what may be going on in some low quarter scarcely a couple of streets from where they stand. Yet it is the duty of such a teacher to prepare the boys and girls who inhabit those same streets for all the rough and tumble of a life in town. Their temptations can never be understood or real help offered unless the circumstances are envisaged in their concrete detail, sordid as they often are. It seems far better that a mother or a teacher should learn the nature of these things beforehand from the cold pages of a book, than that it should come home to her, too late, from the downfall of a child who has been under her care.

<sup>15</sup> I have commented above on the multiple results of alcoholism in the offender's family (p. 96): a word or two is necessary on the ill effects of alcohol in the offender himself. The use of alcohol by the older delinquent may conduce to misconduct in a variety of ways. He gets into bad company, spends money to excess, and so is tempted to steal; during the intoxicated stage, he gives way to passions and seductions which normally he might resist. In other chapters I have noted the baneful influence of alcohol upon the mentally defective, the tem-

club<sup>16</sup>—I need say but little here. Their agency is traceable for evil in but a handful of my juvenile cases, and those, very naturally, the oldest. As a rule, it is not so much the mere presence of these establishments in the vicinity, but rather the inclinations of the offender himself or of his chief friends that prove the determining factors. No district, scarcely any street, is without its tavern at the corner; and to youths and girls old enough for such diversions, a dance hall or a night club is always accessible by tube or bus, even if none exist in the vicinity. On the other hand, the presence of a low Bohemian café near to the young adult's home will often work far greater mischief than any of the resorts more frequently denounced. The cheap and stifling restaurant kept by a foreign cook of alien morality and anarchical creed, a shabby little shop in a side street, with a dozen

---

peramentally unstable, and the adolescent of either sex (see Chapters V, VII and XI). The majority of the cases that come to me, however, are scarcely old enough to yield valid statistics on this point. Among young people who have not long left school, the few serious instances that I have encountered are those of girls who have taken to drinking with their friends, very frequently at night clubs, and have found their moral inhibitions lowered as a result; many have cultivated in solitude the taste thus acquired in company and, having insufficient means for such indulgences, have taken early to theft and immorality as well as to intemperance. As regards youths, the chief offenses committed under the influence of liquor are those of a loosened pugnacity. But few young lads are to be seen these days inside a public house; with them the more serious and insidious consequences of drinking to excess do not come till a later age.

<sup>16</sup>A common source of trouble in connection with dance halls and night clubs is the ensuing squabbles with parents over the question of late hours. The youth usually holds his own in these matters. But the girl is often driven to an open rupture. In most of my cases under this head the girl's antisocial habits dated, not from the first attendances at such clubs, but from the final breach, tacit or outspoken, with her family upon this minor point.

The modern music hall hardly falls within the list. It is true that, in the suburban "palaces," the program as a whole is calculated to lower rather than to lift the ideas and ideals of the audience: and harmful friendships are very often formed by the weekly frequenters of the gallery or pit. But the character both of the performance and of the regular spectators has, during recent years, been very greatly raised. Nowadays, the main connection between juvenile delinquency and the stage lies in the special features of a theatrical life itself. (See below, under the general heading of Employment, page 172, footnote 36.

small metallic tables over which one can lounge all day for the price of an occasional cup of tea and a curtained room at the back where one can dance to the tune of a mechanical piano and meet equally disreputable acquaintances of either sex and diverse nationality—such a place at certain hours will swarm with youthful jailbirds. Here they will exchange stolen property, plan future enterprises, and at times engage the room upstairs for purposes more shameful still. Here the young waiter or page boy, when times are slack and work is scarce, can usually obtain a meal from an older pal in return for some questionable service. Here the young girl who is weary of the search for work yet wishes to be free from home restraint finds it convenient to loll away the vacant hours, and perhaps to receive a clandestine correspondence which she dare not have forwarded to her parents' address. Here young people of every class may quickly cultivate an intimacy that leads them farther still on the downward path to crime. And here, I may add, the watchful student who seeks to know the adolescent offender in his most natural moods will find a museum of types and a rich field for his investigation.

### *Defective Facilities for Amusement*

Districts where facilities for amusement are too few may be almost as fertile in young criminals as those where such facilities are too great. How devoid the ordinary home is of room for recreation and of equipment for indoor games, we have already observed. If, outside the home, the immediate neighborhood is equally devoid of recreative outlets, then the temptation to unwholesome forms of excitement will be doubly great. The result is largely reflected in the sketch map of juvenile delinquency, reproduced above: in almost every quarter of London, the incidence of crime is high in areas most remote from open spaces where there are no parks, no playing fields, no recreation grounds. The correlation between the percentage of young offenders and the amount of open space per acre of land was  $-.22$ . Thus, looking only to facilities outside the home, a maximum of cheap indoor attractions, like the dance hall or the cinema, and a minimum of free outdoor attractions, like the

football field and the public park, combine to characterize the regions of juvenile crime.<sup>17</sup>

The want presses most severely on the child of school age. Older youths can get access to distant grounds by bus or tram. The boy of eleven or twelve has no coppers for the ride and, unless of a roving spirit, rarely trudges on foot more than half a mile from home. It is this dearth of outdoor space that condemns him to turn his street into a playground. In sheer self-defense, as we have seen, the mother with a large family and a small apartment has to pack her children out of the house for their games and amusements; though out of the house, they must yet keep near at hand to be called or fetched for errands, meals, or bedtime: hence, should there be no field or public garden within a few minutes' tramp, the child is forced to play his simple games—knuckle-bones, hopscotch, or last-across—on the doorstep or in the road. And the street not only offers direct enticements to theft and willful mischief, but also makes the worst sort of training ground for the sober citizen of the future. Sustained and systematic activity is there impossible. If the small boy starts a round of marbles, the rain or the traffic will presently interrupt it. If, with a lamp-post for a wicket and a bit of board for a bat, he tries a turn at cricket, the constable will presently move his little team along. But far more enthralling than any organized game of strenuous sport is the crowded succession of inconsequent episodes which a day in a London thoroughfare unfailingly affords—a man knocked over, a woman in a fit, a horse bolting off with the cart on the pavement, a drunkard dragged along to the police station by a couple of constables, a warehouse or a timber yard blazing in

---

<sup>17</sup> On comparing the figures for the two conditions taken separately, it might seem at first sight that an abundance of facilities was more harmful than a deficiency. Unusual facilities for amusement were noted in nearly 11 per cent of my cases; defective facilities (outside the home) in only 3 per cent; the former feature seems more common in the girls' cases; the latter in the boys' (see Table VI). But when the differences in the percentages are based on so small a sample, they must not be too seriously stressed. I may add that a similar correspondence between the absence of open spaces and the presence of juvenile crime has been noted in a survey carried out at Liverpool by Mr. F. J. Marquis, formerly Warden of the Liverpool University Settlement.



the midst of twenty fire engines. Life for the street arab is full of such random excitations; and becomes an affair of wits and windfalls, not an opportunity for steady, well-planned exercise.

### *Places Where Offenses Are Committed*

The facts and inferences that I have just put forward are strikingly confirmed by a systematic inquiry when and where the young delinquent mainly carries out his misdeeds. For every offender brought to me I have always asked the time and place of his offense. The places may be classified under seven separate heads. Of the total number of offenses, the proportion committed in each place is as follows: (1) at home, 20.4 per cent; (2) at schools, 11.2 per cent; (3) at the offender's place of business, 5.6 per cent; (4) at shops and similar places (stores, warehouses, public libraries, etc., excluding places where the child himself is working), 9.1 per cent; (5) on enclosed premises out of doors (freight yards, railways, etc.), 6.8 per cent; (6) in the streets, 34.7 per cent; (7) in parks, fields, and other open spaces, 12.2 per cent. Thus more offenses are committed in the street than in any other single place. Offenses at home, at school, or at work, together barely make up one-third of the total. And, taken as they stand, the figures clearly suggest that the supreme opportunity is generally found during the delinquent's vacant hours.

### *Times When Offenses Are Committed*

The importance of the leisure periods is shown more clearly by a detailed analysis of the times. In each case I have tried to ascertain the month, the day of the week, and (as nearly as can be discovered) the hour of the day when his offense was perpetrated. The results are summarized in the tables that follow.<sup>18</sup>

---

<sup>18</sup> Where, as is usual, a single delinquent has carried out a series of offenses, each on a different occasion, I have generally selected the chief or the most recent—that is, as a rule, the offense that has led to official proceedings against him; failing verifiable information concerning this, I have noted the general time at which his various offenses seem mostly to have been committed. Sometimes, as in the case of truancy or staying

TABLE VII.—RELATIVE NUMBER OF OFFENSES COMMITTED DURING EACH DAY OF THE WEEK

Sun.	Mon.	Tues.	Wed.	Thurs.	Fri.	Sat.	Total
23.8	8.3	10.0	14.3	13.3	9.0	21.3	100.0

TABLE VIII.—RELATIVE NUMBER OF OFFENSES COMMITTED DURING EACH PERIOD OF THE DAY

0-9 a.m.	9 a.m.-12 noon	12 noon-1 p.m.	1-2 p.m.	2-3 p.m.	3-4 p.m.	4-5 p.m.	5-6 p.m.	6-7 p.m.	7-8 p.m.	8-9 p.m.	9-10 p.m.	After 10 p.m.	Total
1.3	3.0	4.3	3.4	6.0	7.7	23.1	10.2	19.7	6.8	8.5	4.7	1.3	100.0

Of the seven days of the week (Table VII), the first is evidently the day of crime. Nearly a quarter of the offenses take place on a Sunday; and over one-fifth on a Saturday. Juvenile

out late, the hour assigned is a little arbitrary—the offense having sometimes to be split into fractions among two hours or more. Hours, days, and months all show suggestive differences for boys and girls, for children under and over school age, for young persons in work and out of work, and for different districts of London. But even were my data numerous enough to allow of these finer distinctions, space would not permit me to discuss the details, or to indulge in conjectures upon the varying causes.

The percentages given in the tables cover a period of ten years between 1913 and 1923. The war does not appear greatly to have affected the variations here discussed, the chief discernible feature during the war being an additional rise for the dark winter months from November to February or March. The annual figures for juveniles, particularly among boys, were greatly augmented by the war; but this is a wider problem hardly relevant at this point and one which has been sufficiently canvassed in recent literature upon the subject. (See, for example, Cecil Leeson, *The Child and the War*, P. S. King and Son, 1918.)

The probable errors for the differences of the actual percentages from the expected percentage per unit of time are as follows: Table VII (Daily Variations: 300 consecutive cases)  $\pm 1.35$  per cent. Table VIII (Hourly Variations, assuming waking day = 15 hours: 234 cases)  $\pm 1.10$  per cent.

delinquency in London is thus very largely a mode of week-end dissipation. So long as there is neither school nor work, mischief fills the empty hours. Many of the transgressions, it is true, are trifling, such as playing games at prohibited times or in prohibited places. But on occasion the loafing, the roistering, and the aimless wandering lead the idler into depredations far more serious than a mere infringement of police regulations; and some of the most serious assaults and sex delinquencies, as well as a full proportion of pilfering, trespassing, and burglary, disturb the Sabbatical calm. After the lawless expansion of Sunday, the next two days are uneventful. There are signs of a transitory midweek increase, enhanced, perhaps, by the half holiday of certain schools on Wednesday and the early closing of certain shops and businesses on Thursdays. Friday, once more, seems almost as tranquil as Monday.<sup>19</sup>

The different periods of the day (Table VII) show variations yet more striking than the different days of the week. Once again the hours of school and work are times of relative sobriety. But what is most conspicuous is the fact that juvenile crime, with rare exceptions, is confined to the late afternoon and evening. Four-fifths of the offenses are committed after 4 P.M.; more than half of them in the hours just before or just after teatime; and the point of greatest frequency falls in the first short spell of leisure on the way back from school or business. The tired and hungry moments, at midday when work or lessons are over, and again towards nightfall when the offender has been staying out with neither food nor supervision, are also periods disclosing a perceptible rise.

#### *Seasonal Variations in Juvenile Delinquency*

Figures for the monthly variations will be found in the last column of Table IX. In Figure 6 the figures have been

---

<sup>19</sup> Somewhat similar figures are reached in the inquiries conducted by the English Committees of Juvenile Organizations (*loc. cit.*, p. 20) and Scottish (*loc. cit.*, p. 6). Both differ from the present in showing a lower percentage of offenses on Saturday. In the English inquiry, at one of the four towns studied, Sunday yields the lowest proportion of crime instead of the highest; and it is instructive to learn that this exceptional city is one already celebrated for its Sunday schools.

charted as a seasonable curve.<sup>20</sup> Beneath it, for comparison, is placed the corresponding curve for the monthly variations in adult crime.<sup>21</sup> In adult crime the marked fluctuations discernible from month to month have been attributed by most criminologists to reasonable changes in temperature.<sup>22</sup> Accordingly in the same table and figure I have shown the monthly variations for temperature in London, and have added similar data for the chief aspects of the weather—for sunshine, for daylight, and for rain.<sup>23</sup> It is strange that, for offenders in this country,

---

<sup>20</sup> It is far easier to obtain trustworthy information about the month in which an offense was committed than about the day or the hour. Accordingly my figures upon this point relate to a larger number of cases, approximately a thousand in all. Where, as often occurs, a single child has committed more than a single offense, I have tried to find out in which month each separate offense was enacted. Thus, my ultimate analysis covers a total of 2,402 offenses. To teachers and others who, with this particular problem in view, have aided me by making careful inquiries and by keeping, often over a period of many years, the most careful records, I am here profoundly indebted.

<sup>21</sup> The data for monthly fluctuations in crimes (indictable offenses) committed by adults are taken from *Judicial Statistics (England and Wales)* for the years 1900 to 1909 inclusive. These are the last years for which figures are given separately for each month under the general heading of Police Returns: from the year 1910 onwards, the publication of a monthly tabulation ceased. The total number of crimes committed by adults during the decade selected for this comparison amounted to 916,852.

The ordinary compilations of monthly figures introduce a spurious correlation owing to the fact that the calendar months vary in length: February, for example, when contrasted with other months, is apt to show a 10 per cent decline in crime simply from its short duration. I have, therefore, throughout equalized all the months to the arbitrary length of one-twelfth of a year ( $30\frac{1}{2}$  days), and have adjusted the official figures accordingly.

<sup>22</sup> The influence of temperature on crime has been most clearly stated by Aschaffenburg, *Crime and Its Repression* (1913), p. 24. He considers that "the organism is subject to acute periodic changes" which are "directly affected by changes in heat"; and argues that the rise and fall are shown most clearly by the instinct of sex. Sydney Smith, it may be remembered, once declared that "it is impossible to feel affection above seventy-eight degrees or below twenty. Human nature is then either too solid or too liquid; and lives only to shiver or perspire."

<sup>23</sup> The meteorological data I have taken from *London Statistics* for the ten consecutive years covered by my records of juvenile delinquency. Except for rainfall, the curves are fairly typical of seasonal fluctuations

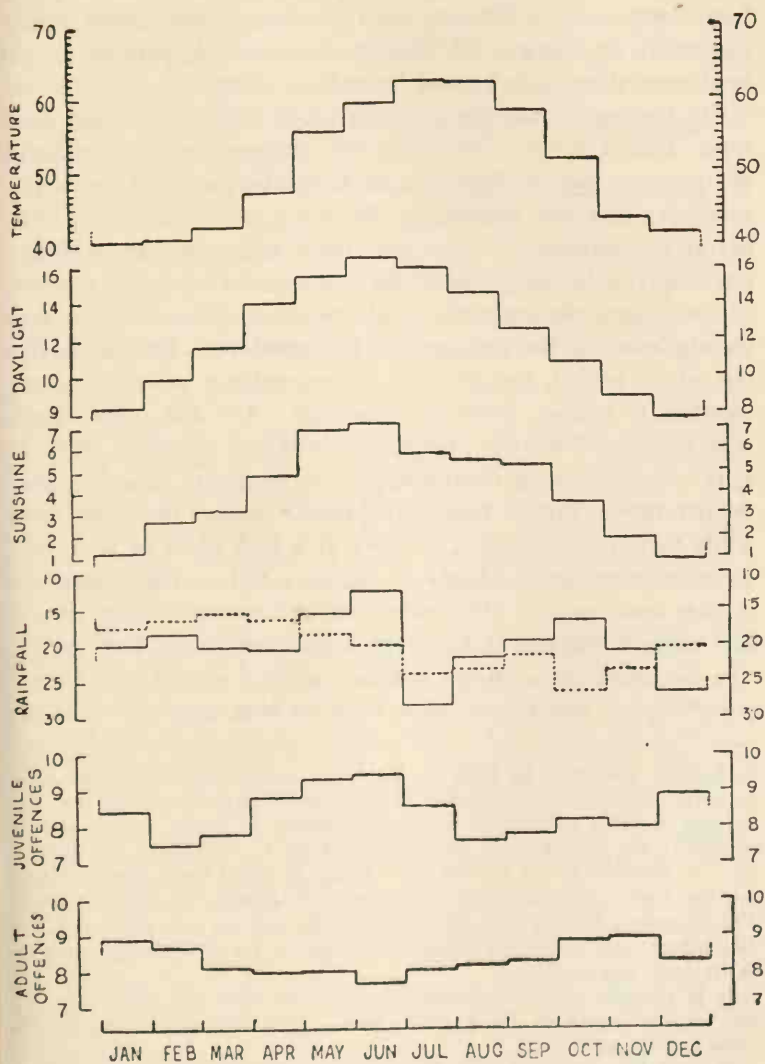

FIG. 6. MONTHLY FLUCTUATIONS IN JUVENILE AND ADULT CRIME, COMPARED WITH VARIATIONS IN WEATHER



whether juvenile or adult, scarcely any comparisons of this nature have been made. English writers, for the most part, have been content hitherto with quoting figures from Italy, Germany, or France, as though they were applicable to all territories alike regardless of latitude or climate.

On looking at the curve for juvenile offenses, several features strike the eye. There are two maxima and two minima: the maxima fall in June and in December, not far from the solstices; and the minima in February and August, a little before the equinox.<sup>24</sup> Since the rise in early summer is higher than the rise in early winter, there appears some small amount of concordance between the total amount of juvenile crime and the duration of the day and of the sunshine. But on taking the whole period, the absolute correspondence with the actual weather is neither large nor constant. On the other hand, with change of weather, no matter in which direction, there is a far more definite relationship. As daylight, sunshine, and temperature increase together, juvenile crime increases too; while they are stationary, whether at a high point or at a low, juvenile crime tends slowly to decline; and as they diminish, it rises once more. The reader will call to mind many quaint and ancient utterances in rough conformity with this result. "In the active season when summer begins," says the old Greek poet,<sup>25</sup> "goats are fattest, wine is at its best, men are weakest,

---

in London. Rain in its monthly incidence varies erratically from year to year. In Figure 6, therefore, I have inserted a dotted line for the average monthly rainfall at Greenwich during the entire century (1820 to 1919); the averages are taken from M. de C. S. Salter's monograph on *The Rainfall of the British Isles* (1921, p. 190): these averages, too, are the figures for rainfall used in the correlations with adult offenses. For juvenile offenses, since the later period, with its wet Julys and dry Decembers, was somewhat exceptional, figures for 1913-23 have necessarily been employed.

It is singular that meteorological observers make no correction for the varying length of the months: this I have ventured to do, by the same method as before.

<sup>24</sup> The table given by Clarke Hall for the monthly variations in charges brought against boys and girls at the Old Juvenile Court shows a similar twofold rise—in summer and winter respectively (*op. cit. sup.*, Appendix E, p. 191).

<sup>25</sup> Hesiod, *Works and Days*, 584-6.

and women most wanton"; and among medieval astrologers it was a common aphorism that human beings were most excitable during the equinox of spring and least excitable after the winter and the summer solstice. The notion of a "spring fever," making the minds of children restless and perverse from March to May, was held by our grandmothers to account for many youthful aberrations.

To look, however, solely for a connection between seasonal conditions and crime as a whole is scarcely valid; the implicit relations must be studied separately for the separate types of offenses. Tables IX and X, therefore, give percentages for each of the main categories under which adult and juvenile crimes may be classed,<sup>26</sup> and in Figures 7 and 8 these figures

---

<sup>26</sup> The classification of adult offenses adopted in Table X follows very closely the classification used in the official reports. I have, however, divided Class I ("Crimes against the Person") into (a) Crimes of Violence, and (b) Crimes against Morals; from the former, I have omitted offenses numbered 11 to 15 in the police returns (offenses such as abortion, infanticide, concealment of birth, abandonment of children), and from the latter those numbered 26 (bigamy), since from their nature the real occasion for such offenses is likely to have arisen at a time wholly unrelated to the actual month in which the offense itself was committed. Class II ("Offenses against Property with Violence") includes chiefly burglary, housebreaking, shop-breaking, and robbery. Class III ("Offenses against Property without Violence") consists for the most part of larceny in various forms and of fraud and receiving. In Class IV ("Malicious Injuries to Property") the chief offense is arson. Class V ("Forgery and Offenses against the Currency") includes such offenses as coining. The figures for Suicide I have separated from the remaining offenses in Class VI ("Other Offenses"). The remainder (chiefly perjury, riot, and habitual drunkenness) I have kept under the general heading of "Miscellaneous."

The number of offenses in each group were as follows: I. (a) Of violence, 17,738; I. (b) Against Morals, 15,167; II. Against Property with Violence, 107,366; III. Against Property without Violence, 732,769; IV. Malicious Injury to Property, 5,223; V. Forgery, etc., 5,809; VI. (a) Suicide, 23,312; VI. (b) Miscellaneous, 5,956. (The total of 916,852 mentioned in footnote 21, page 154, includes the offenses here omitted from I (a) and (b).) The number of conceptions during the same decade, as given by the number of births, was 1,251,214. With figures so high even minute divergences from month to month must be significant.

The list of juvenile offenses includes the following: 399 offenses of violence and temper, 289 of sex delinquency, 993 of theft and kindred crimes, 259 of damage, and 462 of wandering, truancy, and running

TABLE IX.—MONTHLY VARIATIONS IN JUVENILE OFFENSES AND SEASONAL CONDITIONS

	Temperature, Daily Av. (°F.)	Daylight, Daily Av. Hours	Sunshine, Daily Av. Hours	Rainfall (1914-23) Monthly Av. Inches	Rainfall (1820-1910) Monthly Av. Inches	Violence Per cent	Sex Per cent	Theft Per cent	Damage Per cent	Wander- ing Per cent	Total Per cent
January . . . . .	40.5	8.30	1.27	2.00	1.78	7.5	6.5	9.6	8.4	6.9	8.2
February . . . . .	40.6	9.90	2.65	1.85	1.68	7.0	6.1	8.5	7.0	6.7	7.5
March . . . . .	42.8	11.78	3.11	2.02	1.56	7.8	6.9	8.4	7.0	7.6	7.8
April . . . . .	47.0	13.82	4.72	2.03	1.62	9.1	9.7	9.1	7.6	8.2	8.8
May . . . . .	55.5	15.50	6.97	1.56	1.84	9.7	11.4	7.4	8.9	11.9	9.3
June . . . . .	59.4	16.50	7.27	1.26	2.00	10.5	12.2	6.9	8.2	12.8	9.4
July . . . . .	62.3	16.12	5.75	2.82	2.40	11.1	10.7	7.1	7.2	8.9	8.5
August . . . . .	62.1	14.56	5.54	2.17	2.34	8.8	7.3	7.4	9.2	6.1	7.6
September . . . . .	58.3	12.61	5.29	1.95	2.17	7.0	8.0	7.9	8.9	7.0	7.8
October . . . . .	51.1	10.67	3.56	1.66	2.62	7.8	9.0	8.2	8.9	7.8	8.2
November . . . . .	43.4	8.82	1.95	2.08	2.32	6.8	6.3	8.9	9.8	7.6	8.0
December . . . . .	41.3	7.80	0.93	2.64	1.98	7.0	5.9	10.6	8.9	8.5	8.9

are plotted as separate graphs. Nor will it suffice to gauge the amount of correspondence by mere inspection, glancing at each pair of undulating lines or running the eye down two columns of percentages. The correspondence must be measured. Accordingly I have calculated, for each category, the correlation between the figures for crime on the one hand and the figures for the weather on the other. The coefficients will be found in Table XI.<sup>27</sup>

From the charts it will at once be seen that the total curves, alike for children and adults, are each of them a composite of

---

away. The numbers in each group are comparatively small. It is, therefore, essential to determine whether the monthly variations found have any statistical significance, or whether they may not be due to accident or chance. Taking each observed distribution as a whole, how far does it show a significant deviation from the expected distribution, namely, equal figures month by month? This may be answered by testing the "goodness of fit" by the recognized method. (For the formulæ used see Pearson, *Tables for Statisticians and Biometricians*, 1914, p. xxxi.) On applying the test, P (the probability that mere random sampling would lead to deviations as large as those observed) proves to be as follows: (1) for violence, .40; (2) for sex, .09; (3) for theft, .16; (4) for damage, .99; (5) for wandering, .008; and (6) for the totals, .28. This means that if the most probable distribution of all offenses of violence was really uniform all through the year, then in taking random samples with only 399 cases in each, we should get small irregularities of the size here found in about forty trials out of a hundred. Hence if the figures for juveniles stood by themselves, little significance could be attached to the resultant curve for violence and none whatever to the curve for damage. With offenses in the other classes, the monthly divergences from an even level are large enough, and are based upon large enough numbers, to claim some measure of statistical significance: it is far less likely that they are the mere haphazard effect of the accidents of sampling.

It will be perceived that, from their preponderating numbers, offenses against property dominate the total curve for adult crime; while offenses in which persons rather than property are involved dominate the total curve—at any rate with the present set of figures—for juvenile crime. The percentages for girls differ a little in their monthly distribution from the percentages for the boys. But the girls are too few in number to permit a separation of the sexes. In general, the girls appear to be rather less disposed to truancy and wandering during the early months of summer; on the other hand, they seem rather more liable to sex offenses during the darkening evenings of late autumn and under the mingled influences of early spring.

<sup>27</sup> The meaning of the term "correlation" the non-statistical will find explained on page 51.

TABLE X.—MONTHLY VARIATIONS IN ADULT OFFENSES

	Violence	Offenses against Morals	Offenses against Property with Violence	Offenses against Property without Violence	Malicious Injury	Forgery and Offenses against the Currency	Suicide	Miscellaneous Offenses	Total	Conceptions
	Per cent	Per cent	Per cent	Per cent	Per cent	Per cent	Per cent	Per cent	Per cent	Per cent
January	7.05	7.17	9.21	8.96	7.57	8.52	6.74	9.42	8.85	8.16
February	7.10	6.31	8.72	8.80	7.07	8.84	6.19	7.37	8.63	8.09
March	7.08	6.83	8.30	8.22	8.09	8.51	7.01	7.26	8.14	8.26
April	7.77	8.29	7.81	8.03	8.34	9.58	8.78	6.93	8.01	8.49
May	8.20	9.66	7.29	8.03	8.16	7.68	9.69	7.63	8.02	8.57
June	9.39	10.85	7.41	7.63	7.20	9.01	10.40	8.51	7.76	8.58
July	10.49	12.03	7.40	7.91	7.91	7.90	11.46	8.60	8.07	8.47
August	9.68	10.66	8.73	7.95	8.72	7.92	10.02	7.94	8.17	8.36
September	9.17	8.91	8.39	8.21	9.04	7.77	8.87	8.53	8.27	8.38
October	8.97	7.64	8.51	8.87	9.70	8.90	8.18	9.78	8.81	8.31
November	7.76	6.62	8.94	9.07	10.88	7.98	6.55	10.20	8.92	8.15
December	7.34	5.03	9.29	8.32	7.32	7.39	6.11	7.83	8.35	8.17



subordinate curves; and that these subordinate components belong for the most part to two types, distinct and even opposed. Offenses against persons—that is, offenses of violence, offenses against morals, and, in the case of adults, suicide—all reach their climax in the summer, generally about the month of July; in July such offenses are almost twice as common as in February or December. Offenses against property yield flatter graphs, with the low maxima in or near the winter. Stealing, for example, among juvenile offenders is below its general average from May to October; it rises clear above it during the dark days of November, and shoots suddenly to its apex in December; in January it is still high, and nearly as high in April; then it drops. The fluctuations are not large; but the number of cases on which they are based is big enough to render them significant.<sup>28</sup> To account for variations of this nature solely by a rise or fall in temperature would be difficult. Judged by the coefficients, the correlation is greater with lack of light than with lack of warmth, and there is a distinct but far smaller correlation with the quantity of rain. Both among adults and among juveniles these correspondences are to be perceived (see Table XI), and inquiries into the actual circumstances of particular transgressions point to lines of influence intelligible enough, but indirect and mingled. Wet days keep the child hanging round or about his home; dark evenings facilitate petty theft, wherever he may be; and during the cold, dull weeks of winter there is an undoubted temptation to steal money for some warm and cozy place of entertainment like the cinema. These, however, are but minor causes. On looking more closely at individual reports, I find that a large amount of the stealing during December and January has been immediately prompted by the display of Christmas gifts in the shop windows at this season. With older lads, above the school age, and still more with adults, a strong factor is the winter increase of unemployment; even the younger children are affected as a consequence, since allowances from their parents, either in money or in kind, are temporarily cut down. Moreover the spirit of

---

<sup>28</sup> See footnote 26, p. 157.

the Christmas holiday itself seems to operate as an unsettling stimulus; and in consonance with this there is a similar increase in theft during the Easter holidays, and an increase somewhat less marked during the August and September vacation.

Offenses classed under the heading of damage or malicious injury to property show very irregular fluctuations, and the fluctuations themselves reveal small correlation with the weather. Among the figures for juvenile offenses, indeed, the irregularity may be due almost entirely to the fewness of the cases.<sup>29</sup> The maximum is in November, and in this month I find that no small amount of the damage done is a by-product of the bonfires, the pyrotechnical supplies, and the wave of boyish exhilaration that annually reappear about the time of Guy Fawkes Day [Nov. 5]. More generally, the encroaching darkness at the close of autumn and the limits to adventures abroad that the advance of winter brings favor petty feats of mischief and destruction in streets near home. The slight increase in May and June consists, as the case histories show, chiefly of damage done during wanderings and trespassings which take the child farther afield.

Wandering (with which are included truancy, running away, and sleeping out) is the category that displays the largest fluctuations of all. Offenses under this head increase perceptibly during March and April, rise suddenly during May, and culminate in June. Toward December, there is a second and a smaller increase: life in a cheerless, overcrowded room soon grows tedious; and the child saunters off again, no longer to the parks and heaths and open spaces, but to the shopping centers and the glittering lights of the amusement quarters. This second phase, when correlations are computed, masks the main connection between wandering and the state of the weather; the coefficients, however, are still fairly high for each of the points noted: when the days are long and warm, when the sun is shining, and when there is small prospect of a rainy day, the child is tempted to prefer an outdoor life to staying at home or being shut up in the classroom. During the August holiday, indeed, the figures fall to their lowest ebb; but this is due, not so much

---

<sup>29</sup> See footnote 26, p. 157.

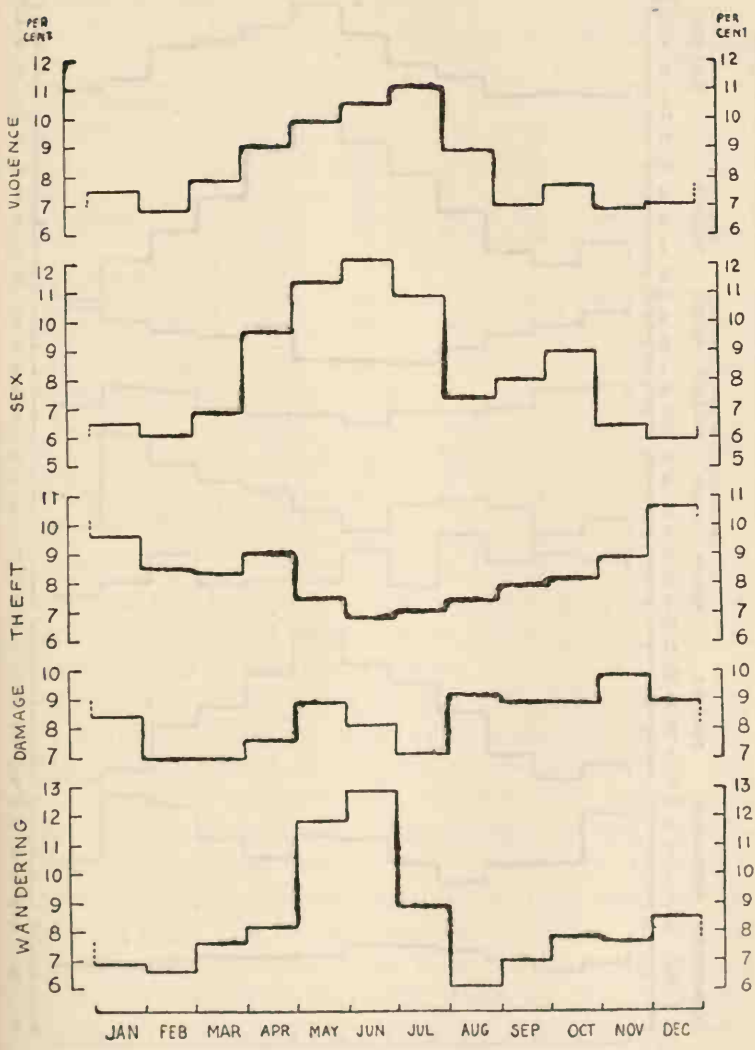

FIG. 7. MONTHLY FLUCTUATIONS IN JUVENILE OFFENSES OF VARIOUS TYPES

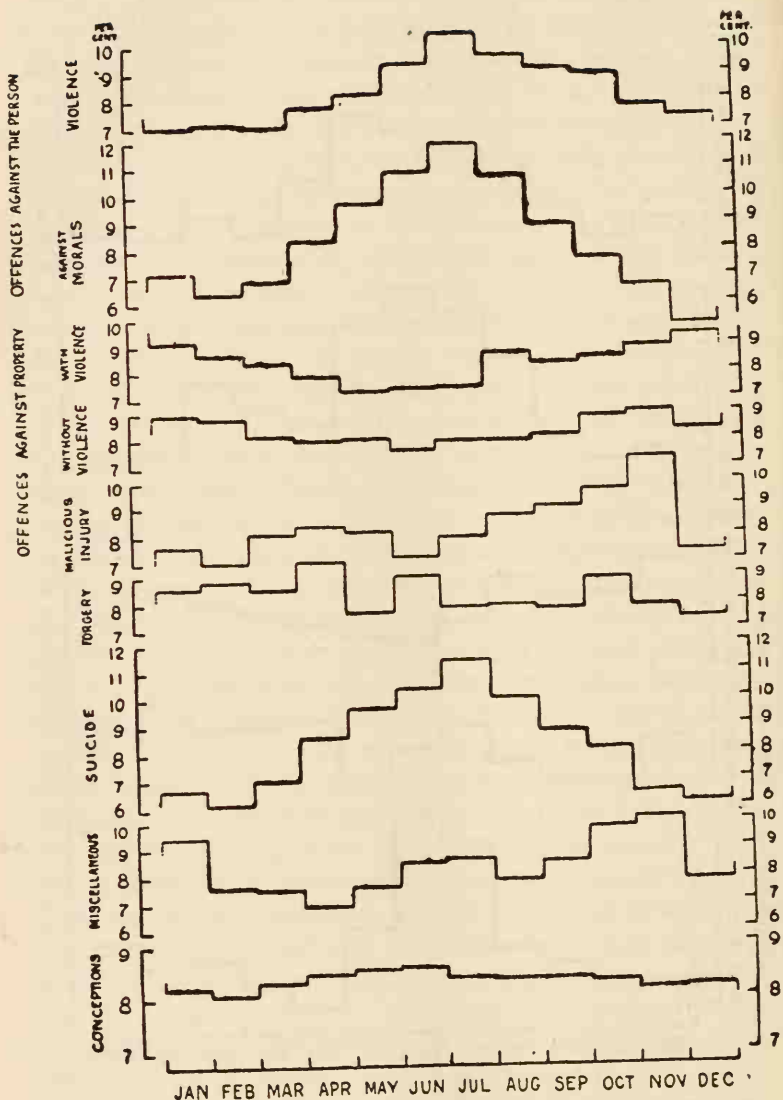

FIG. 8. MONTHLY FLUCTUATIONS IN ADULT OFFENSES OF VARIOUS TYPES

TABLE XI.—CORRELATIONS BETWEEN MONTHLY VARIATIONS IN CRIME AND IN SEASONAL CONDITIONS

	Temperature	Daylight	Sunshine	Rainfall	Conceptions	Corresponding Adult or Juvenile Offenses
<i>Juvenile Offenses:</i>						
Violence.....	.70	.89	.79	-.05	—	.65
Sex.....	.68	.85	.87	-.37	.94	.76
Theft.....	-.84	-.86	-.88	.36	—	[.64]
Damage.....	.15	-.21	-.06	-.12	—	.63
Wandering.....	.35	.56	.60	-.45	—	—
Total.....	.20	.39	.40	-.22	—	-.05
<i>Adult Offenses:</i>						
Violence.....	.95	.72	.71	.71	—	.65
Against Morals...	.93	.91	.88	.35	.81	.76
Against Property (with Violence)	-.63	-.89	-.87	.04	—	.74
Against Property (without Violence).....	-.70	-.85	-.79	.10	—	.55
Malicious Injury..	.07	-.16	-.08	.56	—	.63
Forgery.....	-.20	.10	-.07	-.32	—	—
Suicide.....	.94	.93	.90	.37	—	—
Miscellaneous....	.02	-.32	-.25	.69	—	—
Total.....	-.59	-.83	-.77	.25	—	-.05
Conceptions.....	.77	.91	.92	.09	—	—

to the child now keeping in or near his home, as to the circumstance that expeditions abroad are no longer thought of as an offense or as an occasion for solicitude.

Sex offenses in the young increase remarkably during the early months of spring and come to their summit in June. With adults, offenses against morals yield a curve very similar; and the chronological correspondence between adult and juvenile offenses is here at its closest. With younger persons, the mid-summer holiday, and possibly the festivities of Christmas, appear to furnish counter-interests; and at these times sex offenses are either rare or rarely brought to notice. During the mild, dark evenings of October, such offenses multiply; and the reaction that follows Christmas, if not the dissipations that accompany it, seems to prompt, alike in young and old, a somewhat smaller increase commencing towards the beginning of the New Year. With adolescents, and doubtless with adults, not a little of the misconduct at this season is a demonstrable outcome of alcoholic indulgence.



Usually it has been assumed that the increase in sex offenses during the spring is the result of some annual rhythm in the reproductive instinct, akin to the seasonal phases observable in many animals: and the change is thought to be stimulated by the gradual rise of temperature. Certainly, between high temperature and adult offenses against morality the correlation is extraordinarily large. But for sex delinquencies amongst the young the correlation is higher with daylight than with temperature and with sunshine than with daylight. No doubt the light and warmth of the sun act directly as physiological and mental stimulants; but it is difficult to believe that their direct operation forms the main factor in the outbreak. The curve which I have traced for conceptions<sup>30</sup> shows, by comparison, exceedingly small fluctuations; but with adult offenses against morality it correlates quite highly, and yet more highly still with the more natural sex offenses of the young. The curve rises a little at Easter and reaches a maximum in the early months of summer; throughout the summer holidays it remains above the average; but with the onset of winter it drops: at and just after Christmas there is a slight suspicion of a rise; but by February it has found its minimum.<sup>31</sup>

---

<sup>30</sup> The figures for conceptions are derived from the Registrar-General's *Weekly Returns of Births in London*. The years taken cover the same ten-year period as the figures for adult crime, namely, 1900 to 1909. Within each year I have had to introduce some slight smoothing for the weeks which include Christmas or a bank holiday, since at such a time the registrations are exceptionally low; and, in calculating the monthly percentages, I have taken each month, as before, to have approximately  $4\frac{1}{3}$  weeks. The duration of pregnancy, dated usually from the cessation of the last menstrual period, is commonly given as 274 to 280 days; and births in this country must be registered within six weeks of their occurrence. After inquiries from a few representative individuals who appeared able and willing to give accurate accounts, I have concluded that on an average about 295 days elapse between conception and registration. This interval is a little longer than might otherwise have been deduced. It implies, what seems often to be a verifiable fact, that conception is apt to take place in the first half, rather more than towards the middle, of the intermenstrual period; and that the mother, when she herself registers her child, may wait so long as four weeks after its birth.

<sup>31</sup> On periodicity in sexual phenomena, see Havelock Ellis, *Studies on the Psychology of Sex* (1920), Vol. I, pp. 122-60 and 297-309. After discussing analogous facts, Ellis concludes that the sexual

Offenses of violence or temper present a curve analogous to that revealed by offenses against morals. The juvenile cases, however, would be too few, and the monthly variations too small, for much attention to be paid to the resulting curve were not the corresponding curve for adults of the same general form.<sup>32</sup> Among adults the correlation between temperature and violence is the largest in the list. Among the young, too, as a study of individual instances suggests, changes in the weather play at times an appreciable part. Excess of light, heat, wind, and, to a less extent, of humidity, impose a strain upon the emotional or neurotic constitution: and, in slight but varying degrees, heighten the irritability and diminish the self-restraint of the sensitive and hasty-tempered.

Perhaps it is in part as a result of a similar reaction that during the hot and thundery months of summer the figures, for suicide,<sup>33</sup> like those for insanity,<sup>34</sup> show a remarkable enlargement. Perhaps, too, there are other causes more obscure. Be that as it may, certainly, in their influence on the lesser out-

---

climaxes "constitute one among many manifestations of spring and autumn physiological disturbance, corresponding with fair precision to the vernal and autumnal equinoxes: they resemble those periods of atmospheric tension . . . which accompany the spring and autumn phases in the earth's rhythm, and may fairly be regarded as ultimately a physiological reaction to those cosmic influences" (p. 160). In an appendix to the same volume, Perry-Coste notes the "apparently equalizing influence of married life" on monthly fluctuations in the sexual impulse (*loc. cit.*, p. 302, footnote 2).

Besides the factors commonly named, it is possible that among those affecting, not instinctive activity only, but human fertility also, may be differences in diet, *e.g.*, changes in the vitamin content of the food habitually eaten at different seasons of the year. Knowledge of such effects, however, is not sufficiently advanced to render speculation profitable even were it pertinent.

<sup>32</sup> See footnote 26, p. 157.

<sup>33</sup> On the relation between seasonal changes and suicide, see Morselli, *Suicide*, pp. 55-92, and Durkheim, *Le Suicide*, pp. 84-96. A brief discussion, with a table of monthly figures, will be found in Norwood East's instructive paper on "Attempted Suicide: with an Analysis of a Thousand Consecutive Cases" (*Journ. Mental Science*, LIX, 1913, p. 433).

<sup>34</sup> The admissions to lunatic asylums in London are about 10 per cent higher in the months of early summer than in the winter months; there is apparently a smaller secondary increase during the months of early autumn.

breaks of violence, assault, and simple sexual misbehavior, seasonal conditions seem to act for the most part indirectly. The lengthening hours of sunlight prolong the social day. People spend more time out of doors; more hours of the waking day remain to them after school or business is over; and the time for sleep is curtailed. At such seasons of the year it is tempting for both young and old to range farther from home: as a consequence, children are divided more from their parents; and little groups of youngsters, whether left in the house or strolling off by themselves, find themselves more frequently alone. In this way, the onset of the sunny season facilitates an aimless intercourse of children with children and of adults with each other; it enlarges points of personal contact. Hence offenses in which other persons are involved, whether of temper, or sex, or of plotted truancy, are likely to be augmented. But at the height of the season, owing to the intervention of the August holiday, when outdoor activities are more freely recognized or more deliberately planned, there is an interlude; and for a while such offenses diminish.

On the whole, then, as the figures in the table show, the correlations between juvenile crime and seasonal conditions are far from complete. They differ considerably from one type of offense to another. The largest coefficients are to be found, not among the figures for juvenile offenses, but among those for adult offenses; and the correlations for the former nowhere reach the remarkably high fractions shown by the incidence of suicide and of conceptions. Thus, among London children, at any rate, the connection between crime and the weather is probably far more indirect and complex, and certainly far more attenuated, than previous statisticians on the Continent have implied.

I conclude, then, that the direct effect of seasonal changes upon juvenile delinquency is of small and varying importance. Their influence, such as it is, operates mainly through relationship with holidays, with social habits, with freedom from the discipline of school or from the occupations of business, and, above all, with the presence or absence of adequate facilities for wholesome corporate recreation out of doors. Season, in short,

multiplies opportunity and shifts its character. This, rather than any power of atmospheric conditions over physiological metabolism or instinctive processes, seems the main reason for these curious alternations.

### 3. Conditions of Work

#### Lack of Employment

Although, as we have seen, it is but seldom that grave offenses are committed during the hours of school or work, nevertheless the ulterior motives often lie hid in the petty grievances and discontent that have their origin in the experiences of the classroom or of the delinquent's place of business.

Lack of suitable employment and lack of employment of any sort or kind are two points of capital importance in considering adolescent crime. There is, as we shall shortly see, in either sex and in almost every country, a rapid increase in juvenile delinquency about the time of puberty. A closer scrutiny of the statistics shows just at the age of fourteen a smart drop in the rising curve of crime. But the drop is only momentary. And from the age of fifteen onwards for at least three or four years the increase is resumed at an accelerated rate.

The increase is, to a large extent, unquestionably connected with the problem of employment. Of itself the change from school to business must be sufficiently unsettling. For many a lad the sharp break in life, the new demands, the sudden responsibilities, the accession to freedom, to ampler funds, and to a fuller independence, all these, apart from any strain or temptation within him, put a tax upon his temperament. No longer a pupil but a wage-earner, no longer a child and nearly yet not quite a man, he has left the discipline of the classroom behind him; to the absence of a regular daily time-table he is not yet accustomed; and at the same time he is beginning to escape beyond the jurisdiction of a home he is now helping to support.

Immediately his schooldays are over, the boy is too fully engrossed, either by the search for work or by his new-found job, to have much spare time or energy for mischief. But after a year or two his first blind-alley occupation—as errand boy, perhaps, or delivery boy—comes usually to an end. Or, if

he has never had the luck to find any work at all, a couple of years of continued failure and a hundred refusals, curt, genial, or roundabout, at last hammer home into his mind that there is no room for him in the swollen ranks of industry. Much of the misconduct popularly assigned to the inner stress of adolescence is due, in some degree at all events, to disappointments of this sort.

Lack of work, particularly with young persons who have all but ceased to be young, may, as we have already seen, lead straight to stealing or immorality, for no other reason than to satisfy the pangs of hunger. This motive we have touched upon in discussing poverty in the home; but where the home is not poor but merely mercenary, or where the child has left his home and feels too proud to turn to his parents for assistance, the want of bare necessities may still be the chief incentive. Cases of this simple type, however, are infrequent, at any rate within the age limits with which we are here concerned. Of the delinquent boys in my list only 6 per cent were unemployed, and of the girls less than 3 per cent; or, confining the proportions strictly to those of an employable age, 16 per cent and 6 per cent for the two sexes respectively. Among these, not one was in actual need of food, clothing, or shelter; and the effect of unemployment was in their case far more subtle and insidious. Several I had known as children at school. And it was plainly the deepening sense of failure that had wrought within their moral fiber a slow but steady dilapidation, and had converted, within a few short years, the bright-eyed, high-spirited chatterbox of twelve into the slouching, scowling, taciturn loafer of eighteen.

Not a little depends upon the attitude of the parents. The boy's own natural restlessness may be aggravated by their reproaches. His mother perhaps grumbles every time she feeds him and whenever she finds him hanging disconsolately about the house. His father threatens to turn him out of doors unless he quickly gets a job. Thus harried and hustled, he may be prompted to make money by illegitimate tricks, bringing it home under the pretense that at last he has secured a situation. During business hours the supposed worker must not be visible; he goes off to a café or park and occupies the hours of idleness



by thinking out fresh shortcuts to further cash or by pastimes that lead to intimacies and practices no less depraved.

The case of the girl is similar but more complex. It is in the evening that her chance for illicit earnings is most likely to occur. And at first frequent evenings out of doors are apt to be discountenanced. Even if she has not regular employment elsewhere, she can usually make herself serviceable at home. It is, for the most part, after she has obtained her first job and has acquired a certain range of independence, and then perhaps left home for lodgings, that a renewed interval of idleness is liable to be followed by delinquency. But so long as the parents are sympathetic and helpful, and the young person herself a girl of normal stability, the period of unemployment can, as a rule, be safely tided over. It is seldom that economic reasons alone drive either girl or youth to crime.

### Uncongenial Employment

To get work which is unsuitable may be almost as bad as getting no work at all. As a casual factor, vocational maladjustment has played a very definite part among the older delinquents referred to me for psychological investigation. In my whole analyzed group of two hundred cases, it occurs among more than 4 per cent; or, again confining the proportions solely to the employable, it is found among as many as 10 per cent of the young offenders who already have exchanged school for work. Among youths it is nearly twice as frequent as among girls.<sup>35</sup>

---

<sup>35</sup> In America Healy also, in his studies of adolescent recidivists, briefly notes the fact of vocational dissatisfaction as a possible cause of crime. He writes (*op. cit.*, p. 296) that on several occasions he found "hypersensitive adolescents to whom the vocations they were following were highly irritative, and who showed delinquent tendencies as a result. In others there was a fancied possession of some special talent, accompanied by recalcitrant behavior, because they had no chance to use this special talent." It is, however, upon the personal sensitiveness of the employee that he lays chief stress rather than upon the actual circumstance that the employment itself is unsuitable. His figures are small; classing uncongenial employment together with uncongenial school, he gives as the proportion for the two together a percentage of only 3.6 (*loc. cit.*, p. 136).

We have just seen how the double transition from youth to manhood and from disciplined lessons to an independent life is of itself a delicate crisis. If, in addition, the nature and difficulty of the work are not adapted to the nature and capacity of the young worker's mind, if his new workfellows are uncongenial in their habits or loose in their ethical code, if his foreman is a slacker, a favorer, or a bully, then the moral risks are trebled.<sup>36</sup> Among the older cases brought to me at the National Institute of Industrial Psychology, and brought primarily for vocational guidance, not for delinquency or misconduct, youths or girls who are misplaced and unhappy in their occupations prove often on fuller inquiry to have been led already, as a direct result, into unsuspected offenses, such as theft, excessive drinking, or sexual misbehavior.<sup>37</sup>

Of the many instances that I have encountered in these various fields of work, the great majority divide themselves into two sub-classes. / In the one, the work is too difficult and the child too dull. ? In the other, the work is too simple, tedious, or mechanical and the child altogether too bright. There are,

---

<sup>36</sup> With a few of my older cases, mostly girls, the delinquencies arose directly out of the perils or opportunities characteristic of their work: the chorus girl, the program seller, the waitress, the domestic servant, are often exposed to risks and seductions which none but the strong-minded should be suffered to face. With boys street trading has its dangers; but the delinquencies that at one time arose so frequently from this form of employment have been greatly reduced by the provisions of the Education Act of 1918 (Section 13; see also *Home Office Report*, 1923, Part IV). The evils springing from the employment of English children abroad, particularly girls taken to America, France, or elsewhere, to perform in music halls, to sing at cafés chantants, or to dance in dancing saloons, have also been greatly diminished by the provisions of the Children (Employment Abroad) Act, 1913, which in turn amended the Employment of Children Act, 1903. The new restrictions imposed by these statutes, and by the by-laws and regulations framed under the powers they bestow, should be familiar to all who have to deal with young persons above the school age.

<sup>37</sup> Probation officers in London have recently referred many cases of juvenile delinquency to the Vocational Section of the Institute for psychological examination in order to discover what form of employment may be most suited to the child's particular needs. Naturally, among cases so referred, instances of occupational misfit are frequent. These selected cases, instructive as they have been, suggesting indeed many of the comments made in the text, are not included in my statistical analysis.

in addition, one or two minor and more unusual types. <sup>3</sup>Sometimes the work requires a specialized gift, which the child does not happen to possess. <sup>4</sup>Sometimes—and this is perhaps more frequent—a child possesses, or thinks he possesses, a specialized talent or interest, which goes unsatisfied, unappreciated, and unused, in the particular occupation he has found. The upshot is a vague unrest or a bitter discontent. For the most part, however, the misfit is general rather than special: the level of intelligence exhibited by the youth is ill-adapted to the level of intelligence called for by the job. It is not so much that round pegs are being fitted or forced into square holes, but that big pegs are squeezed into tiny holes and little pegs dropped into larger holes too roomy for them to fill. Examples of each of these several types I shall illustrate on a later page, in treating of delinquents whose intelligence is above or below the normal.

### *Uncongenial School*

The mental and moral harm that an uncongenial occupation works upon older youths may with younger children be effected by an uncongenial education. At times the rapidly growing boy comes to feel an intense and unreasoning aversion towards the school he has hitherto been fond of; and his dread of being shut up indoors, hemmed round by the four walls of a classroom, may develop into a mild degree of what in the neurotic would be diagnosed as claustrophobia—a horror of close confinement. The strain of sitting still for five hours a day over lessons for which he has neither taste nor ability is apt to induce in an active frame a vigorous recoil—if not during schooltime, then directly school is over. “You can’t teach a calf the violin,” says the wise house master in Rudyard Kipling’s story, “and, if you try, the creature’s apt to kick out.” The zoölogy may be faulty, but in its intended application to the young of the human species the psychology is sound.

The spirited youngster attending a city day school is here at a grave disadvantage: his wealthier prototype, sent off to a country boarding school, is much more fortunate. “Stalky and Company,” each cribbing from the other the lessons that he

cannot perform for himself or "coveting" the books and bats and butterfly nets from the lockers of the fags, "Beetle" smoking in the remoter corners of the grounds, "Turkey" turning off the gas supply from all the classrooms, "Stalky" himself instigating the drunken carter to wreck the form-master's study—these boisterous young people may have been heroes to their set, but at an ordinary Council school in a staid industrial town they would have quickly found themselves charged as juvenile offenders.

The influence of an uncongenial school I have noted in 4 per cent of my total list of cases, or, reducing the total to those of school age only, nearly 7 per cent. It is commoner among boys than among girls; and maybe the sole or preponderating factor.

The particular form which the maladjustment takes differs greatly from one case to another, and it is the great weakness of most schools that they so seldom trouble to analyze the reasons for their failure. The child himself will often confess that school is a place that he hates; yet why he hates it he is usually unable, or at any rate unwilling, to explain. His lessons may be uncongenial; his schoolfellows may be uncongenial; or his masters may be uncongenial. The dull child in a class too high for him, the bright child in a class too low, the child of lively spirits disciplined with an almost military strictness, the big lazy fellow in a class of sharp but timid little youngsters, the boy with a special mechanical bent for which an academic curriculum can find no place, the girl with a peculiar disability in arithmetic who is forced day after day to attempt horrid and impossible sums, the weakling who from the poverty of his home or the peculiarity of his person becomes a butt for his more jocular companions, all are in a mood for grave or petty misconduct—ready to react against the vexations of their lot and to vent their half-realized grievances in cheating, spitefulness, bullying, running away, or even attempted suicide. Illustrations of the different types I shall again postpone to a later chapter. One example, however, I may here very briefly relate for its somewhat unusual features. Unlike the commoner case, it is an instance of trouble, not in an elementary, but in a public school.

Martin,<sup>38</sup> the son of a Commander in the Navy, was expelled from his school for theft. He had taken a watch belonging to the master of his form and had broken open a money box which was the property of his house. Acting on his house master's advice, his stepmother sent him to me for examination. He

---

<sup>38</sup> *Age:* 15½. *Home Circumstances:* The boy's own mother was dead; and the father had remarried. The frequent absences of the father from home had deprived the boy of the advantages of masculine discipline. In earlier years, being the eldest boy, he had been somewhat spoiled by his mother. In all other respects, both moral and material, the home left little to be desired.

*Family History:* The boy was the eldest of three children, the other two being described as perfectly normal. The family history included several cases of slight temperamental instability and of well-marked intellectual powers; two of his relatives were men of all but the highest rank in political life.

*Physical History and Condition:* Scarlet fever at three, influenza at twelve. No other infectious disease. Frequent catarrhal attacks. Slight visual defect. Mild headaches of a migrainous type. Growing pains. Well-marked signs of slow and difficult puberty. Marked tremor of hands; slight twitching of the muscles of the mouth: knee jerks brisk and equal. No signs of neural disease. Height, 167 cm.; weight, 47 kg. (He was said to have grown nearly six inches in a little over a year.)

Plays Rugby football (forward for junior house team); but is "not keen on games."

*Intelligence and School Attainments:* See above. His performances in group tests of intelligence place him as about the brightest in a random sample of a thousand. Detailed tests of special capacities and of attainments in the curriculum of the secondary school show that his abilities are exceedingly uneven; and to a master accustomed to handling bright public-school boys, his cleverness might appear in some respects superficial.

*Temperament:* Unstable and repressed: "narcissistic," unadaptable, and intensely vain; well-marked symptoms of what might be termed a "superiority-complex," due to the petting received in earlier years and to an undue sense of his own cleverness and good looks. Mild compulsive neurosis with slight anxiety symptoms.

As so often happens with brighter and older boys, the factors in this case were highly involved. I have taken the unsuitability of the school to be the chief factor in the boy's delinquency; had the boy been differently placed, I conceive that no delinquency would have resulted. On the other hand, it is, of course, impossible to accuse the school. It was largely the special nature of the boy's own temperament and upbringing that rendered a public school undesirable. Here, it is becoming increasingly evident that, even where an environmental factor is the principal cause, its reaction on the child cannot be understood without a thorough analysis of his mind and personality.



was a tall, overgrown, handsome lad, with fair hair, an effeminate face, restless eyes, and a quick, nervous flush. His answers to my first questions were somewhat singular. Asked why he took the watch, when he already possessed one of his own, he said: "I suppose it was the glass. I put my pen through it, and then smashed the works." Asked what he did with the money, he replied: "I wanted to pay for some glasses I had ordered."

It proved on investigation that in less than six months he had collected fifty-four pairs of spectacles. Some he had found lying about, some he had taken from the lockers of other boys; a few he had stolen from shops. His apparent thefts were really of the nature of an obsession amounting almost to a monomania.

On testing his intelligence, I found it exceptionally high. At the age of fifteen he had a native ability equal to that of the average sixth-form boy in the best school in the country. His attainments in classics and mathematics, though good, were by no means equal to his capacity. His special aptitudes lay rather in the direction of modern languages and science.

At his preparatory school Greek and Latin had been the staple subjects of the curriculum. But in spite of his distaste for them, he had gained a classical scholarship to a well-known public school. Here, as a boarder in the senior house, he chafed sorely against the necessary conventions and restraints. Rules, roll calls, lock-ups, bounds, the loftiness of the prefect, and the ubiquity of the house master—these excellent elaborations for protecting him from himself started a smoldering fire of inner resentment. He was, indeed, neither bullied nor ragged; and his wretchedness he successfully concealed. In the form room, however, his dislike of Greek went unnoticed; and almost immediately he was advanced from the easy prose of Xenophon to wrestle with the choral lyrics of Euripides. Six months later, still a little homesick, he began to worry over an impending examination for the school certificate; and, catching a slight chill, came near to a physical breakdown. It was soon after that he found relief in stealing. He began by hiding the spectacles of a few studious myopes, classmates of whose progress he had

become unreasonably jealous, and little by little this interest in spectacles grew into a fixed idea.<sup>39</sup> The guilty consciousness of theft added to his repressed anxiety. Other nervous symptoms supervened—headaches, nightmares, and insomnia. And when at last I saw him, the tremor of his hands and the twitching of his face suggested a near approach to chorea. That his abnormalities of conduct were no more than the eccentric manifestations of a mild neurotic disturbance was amply evident. His singular thefts were simply the reaction, highly morbid and illogical, of a sensitive and jealous lad towards tasks and requirements with which his mind was unfitted to cope. He was removed from school, and sent to a London specialist for psycho-therapy. So far, except for one or two slight lapses, his progress has been satisfactory; but prolonged measures will be necessary before he can be expected to throw off the peculiar attitude which he has developed owing to the indulgence of his family and the rigor of his school.

Why is it that the school is not blamed for a child's delinquency more frequently than his home? The reasons, it would seem, are mainly two. First, however much they fall short of the ideal, the material equipment and moral discipline of the average elementary school are by comparison far more enlightened and far less inadequate than those of the average working man's household. Life is more wholesome; time is mapped out and occupied; supervision, both by teacher and by fellow pupil, is constant and effective. Secondly, it is a popular assumption that the home and not the school, parents and not teachers, are the sole guardians of the child's morality. And this assumption, as I have elsewhere insisted, is mistaken. It is my view that the school should not wholly escape responsibility. Just as the school is sometimes impugned for an intellectual ignorance that is really owing, in a large degree, to the limitations of the child's own home, so also the home in turn is

---

<sup>39</sup> The physician into whose hands he was referred, reports to the same effect: "The boy's main reaction [at the public school] appears to have been jealousy, with the almost fetishistic idea that to wear the externals of those superior to him in work would somehow confer their ability." The mental mechanisms underlying such singular obsessions we shall study later (see below, Chapter XIII).

sometimes blamed for failing to provide a moral training that could be given with greater wisdom and a more scientific approach by the professional teacher in the school. Many teachers and many schools already undertake it, and undertake it with success. Where the teacher has but a small class to deal with, knows both the neighborhood and the parents, is naturally gifted with human interests and human insight, and so takes a lively note of the character and conduct of each individual pupil, there delinquents are comparatively few. Accordingly, it may be, and in my opinion it should be, the recognized duty of the State to supplement through its schools—without, of course, detracting from the parents' true responsibility—the disciplinary shortcomings of the unsuccessful home.

### Summary

Outside the child's home, then, these are the chief conditions that make for juvenile delinquency—unemployment, uncongenial school or work, defective or excessive facilities for leisure-hour amusements, the influence, deliberate or unintentional, of adult friends and strangers, and above all the influence of associates of the child's own age. Of all these various agencies none is so powerful as the last. Measured by a coefficient of association, the connection between delinquency and the conditions obtaining outside the home is .29. Compared with the coefficients already cited for conditions obtaining inside the home, the figure is somewhat higher than that for material factors, such as poverty and its concomitants, but distinctly lower than that for social factors.

From this general survey of environmental origins, both outside the home and within it, one main conclusion can be drawn. It is clear that the commonest and the most disastrous conditions are those that center about the family life. In one respect or another, among what is by far the majority of my delinquent cases, the child's domestic circumstances are demonstrably inimical.

To exclaim against the home, however, is easy <sup>40</sup>; and to de-

---

<sup>40</sup> Healy, speaking of the criminal's home, observes (*loc. cit.*, p. 282):

nounce the parents for the faults of their children is an old and well-worn theme. The modern investigator goes deeper. He inquires what it is precisely that makes bad home conditions so demoralizing wherever they exist. We have seen that the points which in popular writings are stressed so repeatedly—drunkenness, overcrowding, general neglect, and all the multifarious impediments that penury imposes—are not of themselves so fundamental as is usually alleged. There are innumerable children, belonging to the same low social strata, struggling with the same disadvantages, who yet do well. There are as many virtuous children in the tenements of Hoxton as there are in the mansions of Mayfair. It is rather, as we have seen, the moral atmosphere of the home and its neighborhood that is significant—the defective discipline, the vicious tone, the gaps and stopgaps in the family circle, the life, the companions and the customs in the houses and in the streets. Accordingly, to view the home in isolation from the individual, to deal with environment as a thing apart, to picture its bad effects as an external deposit which may stick for a while, but can be easily wiped away from the surface, becomes utterly fallacious. Some natures remain unsoiled though sunk for years in mud: others are porous and penetrable; and the grime works into the grain. It is the personal reaction to a given situation that makes a man a criminal, not the situation itself. It is not bad surroundings alone that create delinquency, but the workings of these bad surroundings on the thoughts and feelings of a susceptible mind.

We must, therefore, in the following chapters, pass from the study of external agencies to the study of the delinquent child himself, his physical, intellectual, and emotional characteristics.

---

"Since the delinquent lives there, of course his troubles mainly originate there. If all offenders came from institutions, we could just as well blame the institutions, as we may now blame the homes." But the retort is not wholly convincing. In point of fact, nearly all our young offenders come from schools; yet we do not censure the school. Here is actually an institution in which the child spends one-third of his waking life, far more, probably, than he spends in the actual home itself; yet this institution, though ceaselessly criticized on other grounds, has not so far become a prominent target for the ethical reformer.

We must inquire what are the inner personal weaknesses which give to these outer environmental factors their power to work their worst.

### Treatment

As a rule, when the adverse factors in the child's environment lie not inside the home but without, treatment is a simpler and more successful matter. The methods available may therefore be reviewed more briefly.

#### 1. Conviction Only as a Last Resort

In most cases drastic measures will scarcely be required. If the main source of the child's delinquency springs not from the parents' poverty, weak character, or feeble discipline, nor yet from within the child himself, but wholly from some detrimental circumstance outside his family life, then it will rarely be needful to remove him from his home. To convict a young child for an offense into which, directly or indirectly, he has been led by some older or more hardened comrade, and to send him forthwith to a residential institution, would be as uneconomical as it is unjust. Seldom would it be done, if the facts were known. But too often, from fear, sullenness, or youthful chivalry, the half-innocent agent is content to take the blame; and the actual instigator goes unsuspected and gets off scot-free.

Here the need is manifest for a prompt and sympathetic study of every culprit who is caught—for drawing out the child's own story, not in the public atmosphere of the police court, but in confidence and in private. Among the poorer classes the ordinary parent knows little or nothing about the life of his child beyond the street door. Towards the lad's chief friends the most intelligent families are often strangely unsociable. He is permitted to meet them in the road, but his parents show no wish to see them in the home. His mother never asks about the boys he goes with during his leisure hours; if she learns anything, it is simply their names; of their characters and interests, of what they do when they meet, of what things they plan and talk about, not a whisper reaches her ear. And as a



rule she is the very last person to whom he would confide any untoward encounter.

It is at this point that the services of an unknown stranger, preferably a visitor or social worker with a psychological outlook and a knowledge of the habits of the younger generation, may be helpful both to the family and to the child. Should the family itself take the matter into its own hands, the best expedient is not for the father or mother to cross-question the child upon points that can never be verified, much less to air misgivings that may after all be undeserved, but for one of them to invite the outside acquaintance freely to the house and so form a first-hand judgment of his own. With younger children the views and assistance of a teacher, one who knows the little group at school, may often be invoked with profit.

If the case has already come before the court, and if the court has found that circumstances outside the home are primarily responsible, then its ultimate decision will probably incline towards some less rigorous plan than those described in the preceding chapter. There are many alternatives provided. By Section 107 of the Children Act, instead of committing the child to a reformatory, an industrial school or the care of some relative or fit person, it is possible (1) to dismiss the charge outright, (2) to discharge the offender and place him upon probation, (3) to discharge the offender on his entering into a recognizance, (4) to order the offender, or his parent or guardian, to pay a fine, damages, or costs, or (5) to order the parent of the offender to give security for his good behavior. These milder methods are especially fitted to the cases we are now considering. With the apparent exception of fining,<sup>41</sup> none of them necessitates a conviction. Which of them is the most appropriate in any given instance can be determined only after special investigation.

## 2. *Dismissed*

Juvenile offenders are frequently discharged, not merely because the offense remains unproved, but also because the

---

<sup>41</sup> See page 115.

offense, though proved, is in its own nature venial, or by reason of the incidental factors admits extenuation. Of cases brought before the juvenile courts during recent years, besides the 12 per cent in which the charge itself has been withdrawn or rejected, over 20 per cent have been dismissed though the charge has nevertheless been proved. Of late, however, there has been an increasing disposition to detain the mild offender for a week or two in the remand home, before he is finally set free. To release him forthwith, as is still so commonly done in districts where the work is heavy, is to preclude any time for close inquiry into the causes and conditions that may be active behind some seemingly trivial transgression. Nor ought the child himself to be encouraged to think lightly of legal procedure; if it was probable that the case would be dismissed out of hand, it should never have been brought into court at all.

When the child is discharged, there is little value in taking his own recognizances unless he is already old enough to be earning his own livelihood or to be living away from home. Far better is it to accept the recognizances of the parents.<sup>42</sup> They can be enforced with better success and may promote a keener sense of responsibility in the parent's own mind.

### 3. *Fines Taken from the Child*

For a large number of petty offenses like betting, gambling, or playing football in the streets, the fittest penalty is plainly a fine. Where a charge has been brought on the motion, not of the parent, but of some outside person—provided conditions within the home itself are propitious and the child's own record is good—there simply ordering him to make some suitable restitution, or some small financial surrender, may prove highly efficacious. The primary aim of fining, however, is not the redress it may bring to the community or to the party injured; it is, or it should be, the educational discipline which it involves for the offender himself. Hence, policy as well as justice re-

---

<sup>42</sup> See page 115. During the past year, in 8 per cent of the cases the child has simply been "bound over" without supervision. This, apparently, is held to constitute a sound and sufficient warning for a large proportion of first offenders.

quires that the sacrifice shall really be borne by the child and not (as might often happen in a poor home even where the child himself is a wage-earner) by his father or mother. When the child is under fourteen, it is the parent who must by statute pay the fine; but even so it may still be possible to arrange that the sums be deducted by installments from the child's own pocket money. With these younger cases, however, partly because of the conviction involved, many juvenile courts hesitate to impose such a penalty. With boys and girls over fourteen who are of normal intelligence, and therefore presumably in receipt of a reasonable wage, the infliction of a fine, particularly for lighter offenses, often acts as a sure deterrent. With youths and girls over sixteen, fining is, for reasons to be mentioned later, the most useful and the most usual sentence. Nevertheless, in many instances where fining seems the obvious course, the fact may be that what is needed most of all is not a single, summary punishment, but close and continuous supervision.<sup>43</sup>

#### 4. Probation<sup>44</sup>

For cases of the general type we are now considering more than for any other kind, the system of probation has its unique

---

<sup>43</sup> See page 232. In England fines are imposed in over 30 per cent of the cases dealt with in juvenile courts, and until recently the proportion has been increasing (*Second Report of the Work of the Children's Branch, Home Office, 1924, Table 1, p. 69*). In the Children's Court at New York, fines, except for disorderly conduct, are, according to the published statistics, hardly ever imposed. It would be of the greatest value if a careful and comparative after-study could be made of cases dealt with by fining, so that the respective merits of the English and the American practices could be examined in the light of their known effect.

<sup>44</sup> In the development of the principle of probation, as in the institution of Children's Courts, the world owes much to the lead of America. The first probation officer was appointed in Suffolk County, Boston (Massachusetts), in 1878. In England the earliest legislative recognition of the principle was contained in the First Offenders Act, 1887. But twenty years later, this Act which, as its title implies, could be used only in dealing with a first offense, was repealed by the Probation of Offenders Act, 1907, which, with some slight amendments introduced by the Criminal Justice Administration Act, 1914, is still the governing law.

Out of 1,043 Courts of Summary Jurisdiction all but 166 have now appointed a probation officer: the exceptions lie chiefly in the country

and special merits. It is by far the most appropriate measure where the causes of delinquency lie chiefly in the environment and beyond the circle of the child's own home.

In the system of probation the law provides a method by which an offender, instead of being fined, imprisoned, or committed to a certified school, may be placed, for a period of no more than three years, under the immediate influence of an experienced officer, and, lending authority to that supervision, still requiring the offender to reappear for sentence when called upon, the court keeps suspended over him the ulterior penalties of his offense. The purpose of such a scheme is primarily a process of educational and moral guidance through personal contact. "Mere surveillance is not probation: probation is an intimate and active relation, which deals with all the factors of the child's life."<sup>45</sup>

As a rule the probation officer for children is a woman picked for strength of character, experience of charitable work, and an acquaintance with delinquent children and their home sur-

---

districts. The new Criminal Justice Bill proposes to make it obligatory that every "probation area" (*i.e.*, every petty sessional division separately or in combination) shall have a probation officer appointed by a "probation committee" (*i.e.*, three or more justices appointed so to act). In London the police court missionaries, nominated by the London Police Court Mission (itself until recently a branch of the Church of England Temperance Society), deal with male and female adults and with older unruly boys; and special women officers, appointed by the Home Office, deal with children and (in a few instances) with adult females.

For further details upon the history, nature, and possibilities of probation, the reader should refer to the excellent volume by two American writers, Flexner and Baldwin, on *Juvenile Courts and Probation* (Grant Richards, 1915), to the *Reports of the Departmental Committee* appointed in 1909 to inquire into the working of the Act passed two years before, to Cecil Leeson's book on *The Probation System* (P. S. King, 1914), and to the *Report of the Departmental Committee on the Training, Appointment, and Payment of Probation Officers*, 1922.

<sup>45</sup> The authors of this statement (Flexner and Baldwin, *op. cit. sup.*) add that probation deals "particularly with the child's home." And the Departmental Committee observes that the probation officer "may help to improve the bad homes which are the breeding-ground of child offenders." But these praiseworthy expressions seem to indicate an aspiration rather than to formulate a fact. Limits of time alone would prevent existing officers from coping adequately with bad home circumstances where the parents are themselves non-coöperative.

roundings. But her duties are in their essence professional: they need a specialist's knowledge and a specialist's skill. Hence it is eminently desirable that such an officer should have received, wherever possible, an intensive training in the psychology of delinquency and child life. Courses like those now arranged by many Schools of Social Studies would be helpful; but the ideal plan would include a university department of criminology, a department which should carry on research as well as instruction, which should include in its teaching the medical, the legal, and the psychological aspects of its subject, and which should have power to supplement its lectures and classes by demonstrations and practical work, after the analogy of the chances for clinical experience accorded to the medical student in the hospital ward.

In a city like London the children's probation officer quickly comes to know the more troublesome families and the more useful agencies that exist within her district. She makes a special study of each individual child, often bringing him to some psychological institute to be tested and examined or referring him for such examination through the local education committee. It is largely on the basis of the probation officer's report that the magistrate passes his final sentence.

For effective probation work there is one plain proviso. No probation officer can bring to her cases the individual attention that they need unless either the numbers under her care at any one time are comparatively small, or else, as in America, the chief officer is adequately served by paid assistants and by voluntary workers. If, as at present too often occurs, one solitary officer has as many as sixty to a hundred names upon her books, the most that she can do is to pay a fortnightly call at the home or require the probationers to report progress periodically at her office.<sup>46</sup> For mere supervision such an arrangement might suffice. Supervision, however, is but the first and simplest

---

<sup>46</sup> In London there are 61 probation officers whose work is spread over 14 adult courts, 9 juvenile courts, and the London sessions; 12 of these officers, all women, are specially appointed to the juvenile courts. On December 31 last these various officers had under their care, in all, nearly 3,400 cases. Of this number as many as 942 were children under



requirement. To achieve success a definite project for constructive work, however tentative, should be framed in every instance. What might be called an adjustment chart should be drawn up on paper and checked month by month, so that all recommendations—medical, social, educational, vocational, and recreational—can be followed effectively through. The methods of probation, though no longer the principle of probation itself, are still a matter of experiment; and the work of the probation officer affords a fertile ground for research. It is, therefore, much to be desired that accurate investigations of all cases should be made, and that records, scientifically planned, should be compiled, collated, and eventually published. In each instance, the measures actually taken and the results actually obtained should form the basis of renewed conferences—conferences with suitable experts, conferences with the agencies that lend their aid, and conferences, if need be, with the family itself. It is, indeed, largely as an outcome of this whole process of systematic following-up that the excellent results of the newer American schemes have been secured.

As I have already argued, probation, under its present working, is less effectual in those cases where the chief subversive influences reside within the child's own home. Certainly where home conditions form but a minor and subsidiary cause, the probation officer can still do much; <sup>47</sup> yet if the child is of school

---

sixteen. That means an average for London of between 60 and 80 cases to each officer. I may add that there is much to be said for the view that adolescent boys—lads beyond the age of twelve or thirteen—should be assigned to men rather than to women. On the other hand, officers handling female cases should be assigned the smaller number.

<sup>47</sup> Two changes, however, in the present practice would undoubtedly render it fitted to a wider number of such cases—particularly to those where parental mismanagement is not actively bad, but simply weak or neglectful. First of all, too little provision is at present made for compelling the parent to assist in the carrying out of the conditions of the probation. Secondly, as the Children Act is now worded, penalties such as a fine cannot be imposed upon a child without a conviction being recorded against him; unless the child is unconvicted, he cannot be placed upon probation, and, if he is already on probation, conviction, apparently, terminates it. These are points, I venture to think, that might be remedied. It should be possible without interrupting the probation to inflict a penalty, either upon the parent or upon the child, when the

age, the education authority through its teachers, care committee officials, and voluntary visitors, all of whom have additional advantages in time and in methods of approach, can often do more. But wherever the vice, ill discipline, or indifference of the home remains the chief and dominating factor and is itself beyond all cure, there probation, no matter through what agency, is almost doomed to fail. Too often, solely because the child is young or comes up as a first offender, probation may be ordered automatically. This, however, is unsound. It is the nature of the cause, not the early date of the offense, that should be the determining point. Should conditions within the home seem gravely prejudicial, then the only conceivable ground for making such an order is either that further inquiry is needed, or else that the person implicitly put upon probation is the parent rather than the child.<sup>48</sup>

The splendid success attained hitherto by the probationary system has been largely in those cases where a young person near or not long past the age of leaving school has been gliding into bad companionship or into a misuse of his free time, when away from the oversight of home, of school, or of fellow work-

---

conditions of the probation order or the recognizances are infringed; and where, at the very outset, a penalty is imposed—where, that is, after the first offense the parent is fined, or the child fined, birched, or detained—it should still be allowable to place the child upon probation. It should also be a common rule when the probation order is made to insert suitable and specific conditions in the parents' recognizances; for example, that the parent should obtain a suitable occupation for the child, or that the child should not be allowed to frequent the streets at night or the picture palace, and, generally, that the parents should cooperate effectively with the officer.

<sup>48</sup> When, however, a child is placed upon probation, he may also be required to enter into recognizances, and the recognizances "may contain" (*inter alia*) . . . "additional conditions with respect to residence" (Criminal Jurisdiction Amendment Act, 1914, Sec. 8). Thus the court may insist upon the child removing for a time to a voluntary home. The Boys' Home at Yiewsley, maintained by the London Police Court Mission, and the Farm Colony at Basingstoke, subsidized in part by the same body, are used for this purpose by the London courts with much success. But, as the recent Home Office Report observes, "the essential principle underlying the probation system is supervision of the offender in his own home"; and except for offenders too old for certified schools or too mild for prolonged detention, departures from this principle should be made with caution (*Second Annual Report, 1924, p. 15*).

ers.<sup>49</sup> Such a youth the probation officer can readily befriend. She becomes "his bondsman to save him from prison."<sup>50</sup> The unemployed or misemployed she can aid in their search for congenial work; the solitary or misguided she can introduce to educative influences and to recreative societies and clubs; she herself can prove a helpful confidante and counselor, offering expert aid in the new problems and perils that confront each one; quietly, delicately, resourcefully, yet still with official sanction, she can make a thorough inquiry into all the circumstances of the case; she will be at hand in her constant watchfulness to pull the child up the moment he shows symptoms of a fresh relapse; and should he come before the court again, she will be ready to advise the most appropriate course, lenient, stern, or summary, as the child in the end may require. If the case is really casual, if the sole factors are accidental influences in the delinquent's outer surroundings, he will quickly respond to her influence. The child who is amenable for evil is often equally amenable for good; and it may prove as easy for a sensible friend to guide him aright as for a corrupt acquaintance to lead him astray. But, in any event, where probation is adopted, it should be put into force as early as possible. It would seem that many justices in the provinces refrain from placing boys and girls on probation until they are over fourteen, resorting to the

---

<sup>49</sup> From one juvenile court to another, the proportion of cases placed upon probation differs enormously, some sending as many as 44 per cent, others so few as 1.5 per cent. The efficacy of the probation varies almost as much. Of the total number of probationary cases, about 10 per cent in Birmingham, and about 25 per cent at the Old Street Juvenile Court in London, and about 30 per cent in the two anonymous towns investigated by the Juvenile Organizations Committee, have been found to reappear at the courts on a fresh charge before their probationary period has ended. More accurate statistics, however, based upon more detailed case histories, are urgently needed to indicate under what particular conditions probation succeeds and for what particular reasons it fails. The most obvious instances of failure coming before my notice have been those in which a little more knowledge beforehand might have revealed that probation would be unavailing—children with inherent mental or temperamental defects, children already hardened in bad habits, children coming from homes where the detrimental factors defied all efforts to correct them.

<sup>50</sup> The explanation given to the young probationer on the card addressed to him in the Commonwealth of Massachusetts.

method only in the last extremity, after a long career of childish wrongdoing has been brought to notice. Probation, if it is to be tried at all, should be tried at once, after the first ascertainable offense.

##### 5. Change of Residence

It is my view, then, that probation is more especially suited to cases where the main sources of misconduct are neither in the offender himself nor in his own home. According to the more specific nature of the external cause, more specific treatment may at the same time be applied.

Where the offender is demonstrably in the power of bad companions of his own age, there are several additional remedies, all for the most part obvious and simple. They can be enjoined as part of the probation, and it will be the duty of the probation officer, not only to see that they are carried out in the spirit as in the letter, but also to observe their efficacy. Sometimes a change of school may be all that is needed. Occasionally a change of residence may be desirable as well, since demoralizing associations even if formed in the classroom or the playground are likely to be renewed in the street. The parent, therefore, may be desired to move from a neighborhood which is inimical to his child's moral welfare: or if the parent cannot move, the child may be sent away for a few short months as one of the conditions of his probation.<sup>51</sup>

Where the fault lies mainly with the others, it may be wise to see and study all the child's acquaintances and perhaps take measures to banish the ringleader or to break up the group.<sup>52</sup> To lecture the misguided weakling and then do no more, to appeal to him to "give up those who do him no good" without removing him from their dominance, or simply to shut him up

---

<sup>51</sup> See footnote 48, page 187.

<sup>52</sup> Of the juvenile gang as such, and the best methods of coping with it, I shall speak more specifically in Chapter X. In this section I am concerned simply with the general influence of any undesirable acquaintance upon the single child—whether the acquaintances be one or many, organized into a group or met casually in the school or street; and am looking at the matter from the standpoint of the criminal individual so influenced, not of the criminal gang as a whole.

indoors during out-of-school hours and so deprive him of all recreation, good as well as harmful—such a course, though often the sole refuge of the harassed parent, is usually unavailing and frequently unfair. The child himself has his own loyalty to his comrades; they in their turn, with jeers and solicitations, will make it hard for him to throw them over; and any curtailment of his liberty by prohibition or confinement is likely to provoke deceit, resentment, and even forcible flight. The only effective step, therefore, may be to take the child where his old confederates in crime can neither expect nor oblige him to renew their perilous acquaintance.

#### 6. *Juvenile Clubs*

Removal, however, is not always indispensable. Where the obnoxious alliance is not one of staunch devotion or long standing, a milder course may suffice. After all, the ideal way to combat the influence of bad companions is to provide the boy with better ones—to introduce him to some juvenile society or club where he may be under the silent supervision of friends still of his own age, and where he may learn a deeper respect for himself, and a desire for worthier and more legitimate pastimes. The club, indeed, forms the most promising method of attacking the problem of the leisure hour. Many a young delinquent has been reclaimed simply by enrolling him as a member of an athletic society, of a boys' brigade, or of a Boy Scouts patrol. For girls similar facilities are now increasingly obtainable. Nothing could be more explicit than the testimony of the Commissioners of His Majesty's Prisons: "even in present circumstances," they state in their last report, "it is rare for a lad or girl to be received into prison who has been a member of a good boys' or girls' club, a boy scout or girl guide, or a member of the Church Lads' Brigade."<sup>53</sup>

But the success of such clubs in dealing with the young is so well realized and so widely spread, and so much has already been written upon their methods and their management, that the whole subject, important as it is in this connection, needs no

---

<sup>53</sup> *Report for 1923-24*, p. 6.



detailed dissertation here. One point, perhaps, I may be allowed to stress. Here, as everywhere else, it is necessary to keep in mind both the individual's special needs and the qualities of the particular agency through which it is proposed to meet them. Clubs differ greatly. One is primarily educational, another religious; a third is military, and a fourth athletic and gymnastic: there are differences in rules, in payment, in government, and in tone. Hence, it is always a first prerequisite to choose the right kind of organization for each wayward lad, if he is to settle down as a permanent member, and find in its activities a fuller satisfaction than he draws from a life upon the streets.

### 7. Institutional Companionship

A word must be inserted about companionships that spring up after, as well as before, removal to an institution. Far greater care is needed in regard to the associations that children form both in remand homes and in residential schools. Too often it is through experiences obtained during custody and at the expense of the State that the harmless waif gleans his earliest knowledge of skilled devices for fraud and stealing and acquires a fresh or more intimate acquaintance with immorality and vice; an evil partnership struck first while the new associates are under detention may be privily continued after their release. Joe Bragg was imprisoned at the age of thirteen for stealing a loaf when destitute and hungry: in his autobiography, *The Confessions of a Thief*,<sup>54</sup> he relates with just irony how "the instructions received during those three months considerably improved me in my profession: the Government placed me in a position to learn a trade; and, having learned it, I determined to work at it. . . . Before I was seventeen I had committed a thousand robberies, and had been convicted a dozen times." The danger is greatest with growing girls of tender years, the very individuals whom, because they are least obstreperous, we allow to mingle most freely; many a girl on the verge of puberty has testified that she learnt more evil during

---

<sup>54</sup> Published by G. E. Ardill of the Sydney Rescue Society.

her first twelve hours of detention than she had discovered throughout all her life before.<sup>55</sup>

A greater measure of classification, therefore, should be introduced whereby the innocent may be separated from the hardened, the uncontaminated from the corrupt, the genuine first or moderate offender from the irreclaimable recidivist. Merely to enjoin silence upon all is to provoke rather than prevent a demoralizing intercourse: they will pass little notes, make little gestures, talk inaudibly without moving their lips. Nor is it enough simply to isolate the newcomers in a room together by themselves. It is like sending every incoming patient and sick person together into a single ward, whether he be slightly injured or seriously diseased, scarlet with measles, pale and white with loss of blood, or spluttering the germs of tubercle: who would then wonder at the spread of infection? Psychic contagion is far swifter than physical, and even in the corridors of the police court or the halls of the receiving home irretrievable damage may be done in five minutes or less.

#### 8. *Transference from an Uncongenial School*

The residential institution is not the only place where evil may be learnt. Occasionally the ordinary day school suffers from a passing epidemic of vice. More often, however, the main ground for changing a child's school is not so much that he is forming harmful intimacies with other pupils baser than himself, but rather that the place itself—its tone, its teachers, its methods, and its discipline—are ill-adapted to his needs. In a thickly populated area like London, where schools are packed so near together, it is not difficult to remove a pupil from one school to another. To decide which cases will really profit by such transference is a knottier problem. Masters from time to time apply for the removal of a pupil because he is a menace to other children and a nuisance to themselves; but that a particular school may be unsuited to the child quite as often as the particular child is unfit for the school—this is a possibility often overlooked. The memory of the old uniformity once

---

<sup>55</sup> For statistics bearing on these points, see Table VI, page 125.

obtaining among all elementary schools still leads many to forget that, with the new diversity of methods, there may now be some fresh school to which a difficult child may adjust himself with greater ease.

It is perhaps to be regretted that among many head teachers, both at elementary schools in better-class districts and at nearly all schools of the secondary or central type, the tradition still lingers that there is nothing to be done with a thief except expel him. Often, indeed, in the interests of other pupils, and of the tone and reputation of the school as a whole, the teacher has little option: and when this is his view or attitude, an exchange had better be made without delay. But in general, so far as my own experience goes, no person who has to deal with childish delinquency—parent, policeman, or employer—is more patient and painstaking than the teacher; and a shift should never be ordered until it is first ascertained whether after all the present teacher is not likely to understand the child better than a new one. In any event, the one thing essential is not to change, but to choose, the school. To order a change just for the sake of a change, without further scrutiny of the child's real needs, is likely to be of little effect. In making the choice, the main points to be considered are the personality of the staff and of the scholars, the type of discipline prevailing, and the general atmosphere of the school itself; these are of far greater moment than the methods of teaching or the subjects that are taught. The gradual reduction in the size of classes and the fuller study of each pupil as an individual have done much, and will do more, to render the work of the school increasingly effective with its troublesome cases: above all, the wider meaning now attached to education, the growing effort to train character as well as intellect, the newer schemes for infusing into the routine work of the classroom freer activity and keener interest, will of themselves do much to diminish crime and delinquency in the young.

### 9. *Vocational Guidance*

The problems of juvenile unemployment and of continued education during adolescence are too huge to enter into here.

Nor can I touch upon the well-recognized need for aiding youthful offenders, already committed to a school or institution, in finding suitable work after their discharge. One hopeful sign is the readiness of probation officers to consult the psychologist, not merely about the causes of delinquency in any particular case, but also for scientific assistance in deciding what kind of occupation is best fitted to the child's peculiar bent. These and other attempts to lessen the frequency with which restive youths are placed in blind-alley jobs and unstable girls condemned to the dull drudgery of domestic service have already reduced, as experience and statistics testify, the sum total of adolescent offenses. The movement for vocational guidance is as yet in its cradle. How far all advice upon choice of employment must, if it is to be sound, be based upon a preliminary psychological study of each child's intelligence and aptitudes, is as yet but dimly realized. In this country the National Institute of Industrial Psychology has already made a fruitful start and has bestowed special attention on the needs of the young delinquent. But vocational guidance may be preventive as well as remedial. Adopted as part of the regular machinery for placements made under the Choice of Employment Act, the scientific selection of suitable callings will conduce not only to material prosperity and to industrial efficiency, but also to social order and to personal content.

#### 10. *Increased Facilities for Recreation outside the Home*

To direct and superintend the child's activities when work or lessons are over is a far harder task than to find him a fitting school or to place him in a fitting occupation. Once more, the best approach is to find out the boy's own tastes and inclinations. In a city like London there are, or should be, wholesome forms of amusements to appeal to every palate. Out of doors, cricket, football, organized games, visits to places of interest and note—indoors, dancing, boxing, theaters, concerts, museums, picture galleries, the better type of cinema and music hall, and evening classes upon various subjects—all these may be essayed in their turn. More than once an assistant of mine has volunteered to take some individual offender, smitten with

a craze for seeing life, and has tried to sample almost every kind of legitimate entertainment that the two together could find; rarely during the course of these excursions have they failed to hit upon some one particular hobby that has fired the enthusiasm of the young defaulter. Wherever such a method has been tried, the outcome has been, with hardly any exception, a success. The new-found interest has proved a safe and sufficient substitute for the previous habits of crime: and the old practices have dropped off of themselves, like withered leaves when new buds shoot.

To arrange experimental expeditions of this sort for all whose hearts are set upon their own amusement, is hardly a practicable plan. But there is one simple thing that would be invaluable to the social worker in making such selections. An up-to-date inventory might easily be compiled of all known facilities for leisure-hour employment: whatever resources are accessible in each district to children of different age, sex, mentality, and economic means, should be sought out and set down in a classified list. Two excellent objects would be served by such a catalogue—a maximum use of all existing opportunities and the continual discovery of places where existing opportunities were too few. In every area these questions should then be put: first, are the known facilities such that every boy and girl may select for each day in the week some program for his leisure hours which shall seem to him personally worth while and which at the same time may tend to elevate his mind and character, or at least never stimulate or invite delinquency? Secondly, does every boy and girl receive adequate supervision at the hands of intelligent and sympathetic adults, so that a wrong choice may be at once detected, and a better choice put before him whenever it is needed? Trusting the child's parent to guide the child's selection will seldom suffice. Whether he knows it or not, the parent nearly always wants the help and advice of the community. Once again, it is to organizations for child welfare, like the juvenile club, that we may chiefly look for assistance. The club alone cannot cater for every evening nor for every free Saturday or Sunday; but the club leader can at least advise each member how to occupy himself with pleasure



and advantage, when the club itself is closed and the members are thrown upon their own devices.<sup>56</sup>

For younger children the provision of play centers and of recreation grounds serves the same purpose. But unfortunately the supply is far smaller than the demands. One attractive proposal for meeting the need upon a larger scale is due to Professor J. J. Findlay. He suggests that on the outskirts of large towns children's day settlements should be formed on vacant land to which those who live in the crowded central slums might be taken for the day; the tramcars in the morning, having brought suburban residents to the center, instead of returning empty might take the children from the center to the suburbs; in the evening, as they return to fetch the workers home again, they might convey the children from the suburban settlement back to the center. But indoor accommodation is needed as well as out-of-door. And one is tempted to urge that the day schools themselves might be utilized for play as well as for work. Every evening, every night, and every day during the vacation, these huge institutions, with their classrooms, their playgrounds, and their spacious halls, are closed. When, on those very days and at those very hours, the demand for room is so pressing, it seems deplorable that, in the thick of the most densely crowded districts, the largest available buildings should stand empty and unused.<sup>57</sup>

---

<sup>56</sup> Useful studies and recommendations on these points will be found in the *Reports of the Cleveland Recreation Survey* (to be obtained from the Survey Committee, 2025 East Ninth Street, Cleveland, Ohio, particularly the reports by Thurstone on *Delinquency and Spare Time*, and by Haynes and Burns on *A Community and Recreation Program*.

<sup>57</sup> During recent years, in London at any rate, growing attempts have been made to employ school premises not only for evening schools, but also for clubs to which either past or present pupils may belong. In a criminal slum in a northern suburb a plan was made for carrying this suggestion still further. It had been found that the conditions under which the girls slept in their own homes were most deleterious, alike to morals and to health; arrangements were accordingly made to organize a club for girl volunteers, who might, if they wished, and if their parents allowed, sleep on the school premises, in the hall during the winter and on the roof during the summer. They made their own bedclothes and night garments, and were looking forward with great zest to the experiment when it was cut short by the outbreak of the war.

11. The Official Regulation of Environmental Factors Affecting the Young and Adolescent

Voluntary and public assistance such as the foregoing, however much it may be extended, can never cover the whole of the problem. After all, the amusements of the people are bound to be furnished in the main through private commercial enterprise—through ventures organized, not for philanthropic ends, but primarily for profit. Where undertakings like these cater for the young and the adolescent, a fuller measure of judicious supervision is a need of national importance. The want can be met in various ways: first, and best of all, by instructing public opinion generally, and more particularly the opinion of parents and of the interested trades themselves, upon the urgency of special caution wherever the child is concerned; secondly, by subsidizing chastened and educative amusements of a popular type, such as might prove a counter-attraction to purely money-making concerns, yet could not themselves be expected to be entirely self-supporting; thirdly, by giving greater powers to local authorities to enforce censorship and regulations, either existing or freshly devised.<sup>58</sup>

What I have said of recreative conditions holds good of all environmental factors, within the home, outside the home, in the factory, the office, and the workshop. The prevention and the treatment of juvenile delinquency can never be carried forward with sure hope of success until adequate control can be exercised over all conditions and all agencies that affect the welfare of the young. As a prime prerequisite for this control, the same authority which investigates, understands, and adjudicates the affairs of the young offender should have full

---

<sup>58</sup> For a special instance of these *desiderata*, see the *Report of the Cinema Commission of Inquiry* instituted by the National Council of Public Morals (1917). A similar inquiry upon forms of youthful recreation might well precede the detailed drawing up of such regulations as I have advocated in the text. Newer agencies, like the Juvenile Organizations Committee in England and the International Association for the Promotion of Child Welfare centered at Brussels, include these and similar problems within their scope; and may, if scientifically directed, do much towards finding a solution.

power to remedy, so far as may be possible, whatever external influences are making for crime. Without such power the proceedings even of the police court itself are bound to become, in one case after another, but a solemn and impotent ceremonial.

## CHAPTER V

### PHYSICAL CONDITIONS: DEVELOPMENTAL

Nor soul helps flesh more now than flesh helps soul.  
BROWNING.<sup>1</sup>

#### The Physical and Medical Examination

So far we have been concerned only with the child's antecedents and surroundings. We have asked what hereditary weaknesses have been passed on to him at birth; we have inquired what hostile influences, social, material, and domestic, have been acting on him from without. We have now to turn our attention to the child himself and to see what special qualities of body or mind he exhibits as his own.

His bodily state must be examined as a preliminary. We inspect the shell before we pierce to the growing seed within. To study a man's mind and morals without first of all studying his physique is to throw away a proffered key on the chance that there may be another in the casket. Whatever be the occult connection between soul and brain, it is essential for all practical issues to treat each individual person as a unitary whole. Material and spiritual are reciprocally involved, and much light may be thrown upon the delinquent's mental failings by a preparatory review of his bodily development and health. No psychologist, therefore, can dispense with a physical and medical inspection, before he passes to what is properly psychological.

I propose in this and the following chapter to inquire what physical conditions seem principally connected with a propensity to crime, and in what manner those conditions operate to produce their demoralizing effects. Tables XII and XIV<sup>2</sup>

<sup>1</sup> *Rabbi Ben Ezra*, XII, 6.

<sup>2</sup> See pages 203 and 240 respectively.

specify the various points observed in my delinquent and non-delinquent cases. It will be seen from the totals that among delinquents such drawbacks are nearly twice as common as among non-delinquents of the same social class, and that they are rather more frequent among the girls than among the boys. The particular facts noted may be considered under two main heads: first, there are those conditions of body which, without being abnormal in themselves, predispose to an abnormal state of mind—of these the disturbances of growth and puberty form the most notable examples; secondly, there are those conditions of body which are in themselves pathological—general ill health, particular diseases, and (of prime importance in the study of misconduct) affections of the nervous system.

### Deviations in Normal Physical Development

It will be remembered that an influential school of criminology, under the lead of Professor Lombroso, has maintained that criminals form a recognizable human type, a class apart by themselves, marked off from the law-abiding population by certain observable and measurable characteristics of natural bodily development—

By the blots of Nature's hand,  
Crook-back, mole, hare-lip, and scar,  
Marks prodigious, such as are  
Despised in nativity.<sup>3</sup>

To refute this belief with further detail is superfluous. No living criminologist accepts it. Its death blow was struck by a unique anthropometrical research, a long statistical inquiry carried out by Dr. Goring upon three thousand adult convicts in His Majesty's prisons. From his careful measurements, subjected to a most exhaustive mathematical analysis, Dr. Goring concludes<sup>4</sup> that "there is no such thing as a criminal class, differentiated by anomalies of physique"; "English criminals," it is true, "are markedly differentiated from the general

<sup>3</sup> Shakespeare, *Midsummer Night's Dream*, V ii, 40-3.

<sup>4</sup> Charles Goring, *The English Convict: A Statistical Study*, 1913, p. 200.



population in stature and body weight"; but "this is the sole fact at the basis of criminal anthropology."

As regards children, recent investigators have reached a like conclusion: the delinquent child as such conforms to no definite physical type. The same reservation, however, has to be made as before. In height, in weight, and in general bodily growth, the delinquent child departs, and that very frequently, from the normal: at thirteen, for example, boys in the industrial schools are nearly four inches shorter and nine pounds lighter than other boys of equal age. And the results of such inquiries are commonly summed up by saying that the physique of delinquent children, though it exhibits no qualitative differences, is yet upon the average inferior to that of the non-delinquent at every year of life.<sup>5</sup>

Here, however, a mere average—the sole form of measurement usually presented—is bound to be misleading. Many delinquent boys are furthered in their violent outbreaks by the fact that their size is not below but above that of their fellows; instead of being under-developed they are overgrown—lusty ruffians, not stunted weaklings. And even among the smaller and frailer personalities, it is the extreme cases that suffer most, not the general mass of the offenders; for, after all, the average of the general mass falls but little beneath that of the ordinary unoffending child from the same low social sphere.

---

<sup>5</sup> The earliest and best-known research upon the physique of delinquent children in England is that carried out by the Anthropometric Committee of the British Association under the chairmanship of Sir Francis Galton upon nearly 2,000 boys and girls at industrial schools in different parts of the country (*Annual Report*, 1883, pp. 253 *et seq.*, esp. p. 296, Table XXI). The figures quoted in the text are taken from this report, the age of thirteen being selected, since the industrial school group was largest at this year. If we compare industrial school children, not with the general average, but with the average of neglected children or of those in poor law institutions, the delinquent still show to disadvantage (compare the figures given by Greenwood, *Health and Physique of School Children*, 1913, p. 88). A rough comparison, however, of the more recent statistics, issued from time to time by various education authorities, suggests that the physique at industrial schools is improving: unfortunately, few trustworthy measurements have as yet been published.

We need, therefore, to trace out some boundary line for normal variation. By the help of a table of means for each year, measurements of stature and weight obtained in centimeters and kilograms may be conveniently converted into equivalent age assessments. Physical development can then be expressed in terms of the corresponding age, much as intelligence is measured by a mental age in the Binet-Simon Scale. When this is done, it appears that a backwardness or advancement equal to two or more years' growth is likely to be significant. In compiling the figures for my tables, this is the limiting margin I have used. A boy over twelve with the height and weight of a normal youngster of only ten or less I regard as definitely under-developed; a girl under fourteen with the height and weight of a young woman of sixteen I regard as definitely overgrown.<sup>6</sup>

With this as a criterion, I find in 12 per cent of my male cases and in 5 per cent of my female cases an excessive or an inadequate development of physique figuring as a probable factor (see Table XII). Of these the delinquent boys are more commonly undersized; the delinquent girls more usually overgrown.

### 1. The Undeveloped

It is only to be expected that, in an industrial area like London, a considerable proportion of the delinquent children will prove dwarfed and sparely developed. In most cases, it would seem, the lack of growth is secondary to some prior pathological state—rickets, malnutrition, or weak health generally—conditions to be discussed on a later page. In a few, however, the small size and the light weight simply constitute an inborn peculiarity, an extreme but natural deviation in a

---

<sup>6</sup> See note on the standardization of measurements, Appendix II. In the group of non-delinquents the amount of variability in physical development seems far slighter than I should have anticipated from previous inquiries among large samples of the population. Possibly the present sample is too small for one to expect a true estimate of the frequency of extreme deviations. Possibly, too, the peculiar mode in which that sample was selected renders it more homogeneous than a truly random sample would prove to be.

TABLE XII.—PHYSICAL CONDITIONS: DEVELOPMENTAL

	DELINQUENT					NON-DELINQUENT		
	Boys		Girls		Average	Boys	Girls	Average
	Major Factor	Minor Factor	Major Factor	Minor Factor				
Undersized.....	0.8	7.3		2.7	6.1	1.5	2.0	1.7
Over-developed (physically).....		4.1		2.7	3.5	0.5	1.0	0.7
Over-developed (sexually <sup>1</sup> ).....	0.8	3.3	2.7	6.8	6.1		0.5	0.2
Menstruation (accompanied by psychic disturbance).....				4.1	1.5		1.0	0.5
Delayed puberty.....		0.8 <sup>2</sup>		2.7 <sup>3</sup>	1.5		0.5 <sup>3</sup>	0.2
Attractive appearance.		3.3		13.5	7.1	1.5	3.5	2.5
Total.....	1.6	18.8	2.7	32.5	25.8	3.5	8.5	6.0

<sup>1</sup> Including premature puberty (*i.e.*, attained before 13.0 years with boys and before 12.0 years with girls). For criteria employed in judging boys see references cited in Appendix II.

<sup>2</sup> Voice unbroken and no marks of pubescence at 17.0 years: (see Appendix II, *loc. cit.*).

<sup>3</sup> Menstruation not commenced at 16.0 years.

characteristic that is highly variable. In boys and youths this lack of physical development, however harmless in itself, will penalize their whole career, operating in much the same way and almost to the same extent as bodily weakness from bodily disease. Whether in school or in after life, the puny individual must fail to hold his own against companions of similar age and of ordinary proportions. The lack of growth may be attended by no deficiency of strength, yet it may bring identical results. In the labor market muscular vigor is gauged by a rough and hurried glance at the applicant's physique; the luckless manikin is turned away despite real health and energy; and for the despised and rejected from whatever cause the path lies swift and easy to dishonesty and crime.<sup>7</sup>

<sup>7</sup> Most English and continental writers have emphasized the seriousness of physical inferiority as a cause of crime (*e.g.*, Morrison, *Juvenile Offenders*, p. 102). Healy's figures, however, are exceedingly low—only 5.2 per cent for males, and for females zero. Apparently, in America, where social conditions are more fluid, where the chances of employment are much greater and the poorer classes better fed, this factor has less weight (see *The Individual Delinquent*, pp. 236-8).

To the working girl neither size nor strength is so essential; the physical handicap is less severe or works in ways more subtle. The case that follows, however, is that of a girl delinquent. In some points exceptional, it yet may serve to illustrate how the results of littleness, results so obvious with boys and youths, may also at times overtake what is ordinarily regarded as the weaker sex.

Maggie H.,<sup>8</sup> when I first saw her, was a flaxen-haired young personage in socks and curls, with a very small figure and a very big sash. Her size, her dress, her general bearing suggested the wistful little *ingénue* of eight. Her actual age was eleven; and a discerning eye might easily guess that she was artfully acting a part. By her history, she was an only child, fatherless, and far too lively for the single-handed care of her

---

<sup>8</sup> *Age:* 11½. *Home Circumstances:* An only child, living with her mother in a clean and tidy one-room tenement near the West End. Mother, a cashier, of refined appearance; apparently strong, sensible, and self-respecting. Wages 35s. per week. Rent, 4s. 6d. per week.

Maggie and her mother get on well together; but there is a little intermittent friction because Maggie, like many another of her type, hates housework. And in their single room there is no chance for social life at home.

*Family History:* Father (a bank clerk) died eight years ago of heart-failure. Little is known of the father's family, except that both paternal grandparents died young. Mother's family, healthy and normal. (Mother died later of pneumonia.)

*Physical History and Condition:* Walked at 2 years. Talked at 18 months. Rickets, measles, and formerly frequent attacks of catarrh and sore throat. Health now normal, but looks tired about the eyes. (Slight signs of transitory hyperthyroidism later at 13.) Height, 120 cm.; weight, 23.0 kg.—apparently those of an average child of only 8½.

*Intelligence and School Attainments:* Mental age, 10.5 (mental ratio, 94). Tests of special abilities indicate tendencies to verbalism and to vivid imagery, particularly visual. Reading, 10.0. Spelling, 8.5. Composition, 9.0. Arithmetic, 7.8. Handwriting, 8.0. Drawing, 8.0. Handwork, 8.5.

*Temperament:* Active and somewhat unstable. Histrionic manner. Talkative; imaginative; when six, had an imaginary playmate: is still full of fantasies. Even now, when grown up, prefers simple and childish stories; but "has seldom been known to sit still over a book." Incontinence (fecal and urinary) during infancy; enuresis reappeared for a year or two at 8 (apparently connected with bad sex habits—habits which had not wholly disappeared at 11). No other symptoms of neurotic tendencies.

mother. Originally she was reported to me for being a troublesome rather than a delinquent girl. In the classroom, as was noted both by her head mistress and by each assistant in the school, she was a source and center of commotion, no matter where she was placed. Thanks to her babyish build, she was credited by all with an intelligence beyond her years; her teacher spoke of her as "shrewd and undoubtedly clever." When tested, however, her mental age was found to be barely ten and a half; her scholastic attainments were lower still. It was thus the misleading contrast between her manner and her physique that created the general illusion as of a child unusually bright.

Her first appearance deceived every one. She had a captivating, if self-conscious, glance; and her talk—like her nature, somewhat theatrical—was full of sprightliness and borrowed humor. As with Pope's little lady,

Her tongue bewitched as oddly as her eyes:  
Less wit than mimic, more a wit than wise.<sup>9</sup>

She was at this period working with children of her own stature in Standard [Grade] II. Naturally, as her teacher remarked, she should have been the sharpest in the class, but all her surplus ability was frittered in mischievous pranks and perversities. In worldly information and in calculated daring, she was well above the heads of the nine-year-olds with whom she mixed; and the daily disorder came to a climax when she was found disseminating among her younger schoolfellows rude words and ribald stories, gleaned, no doubt, outside the classroom from bigger friends of her own age. As a result she was transferred to a higher grade answering more closely to her actual years. Here the elder girls at first petted and indulged her; and she became the *enfant gâté* of her class. Then they began to resent the impertinent liberties that she took. Presently she fell in with a clique of bigger boys and girls from a neighboring street who incited her to steal. The district, indeed, was a most undesirable one, a hotbed of thieving and vice. And very wisely the mother now complied with the suggestion

---

<sup>9</sup> *Moral Essays*, Epistle II, i, 47.



that she should move to another quarter. Placed in a different school, where the girls were of a better social stamp and of a higher moral tone, the child gave little trouble for the next two years.

Death, however, removed her mother soon after Maggie left school, and for nearly four years I lost all touch with her. Later on I came once more across her path, and found her a diminutive young woman of eighteen. She complained that she had always met the greatest hardship in searching for suitable work. People were so sure she must be overstating her age; and even when she had obtained a situation, the other girls "put upon her" because she was so small. As I saw her, however, she was dressed, not like a working woman, but (to quote a friend's description) like "a flighty flapper of fifteen," with smart short skirts and loose long hair; and a few weeks afterwards I learnt that, though not practicing actual or systematic immorality, she was in the habit of accosting men in the streets, and getting money from them under the pretense of dissolute offers. At our last encounter she told me that she had obtained a theatrical engagement to perform one of the children's parts in *Peter Pan*, and joining a company about to tour the provinces, passed finally from my sight.<sup>10</sup>

## 2. *The Overgrown*

*Males.*—To be too big may sometimes hamper good conduct quite as much as being too small. The boy whose physical growth is exceptional, whether in rapidity or in amount, is at a disadvantage in various ways. As a rule, his mind does not grow at the same accelerated pace as his body, and for a time it may seem as though the energy that should normally have gone to his intellectual expansion has been largely drained away and exhausted by the excessive development of his physical strength. Hence, during the period of this disparity the youth's temporary state is not unlike the position of the backward child. Physique outstrips intelligence in both: with the

---

<sup>10</sup> Compare also the case of Johnny E., described on pages 131-4.



FIG. 9. MAGGIE H., AGED 18½



FIG. 10. AN OVERGROWN GIRL, AGED  $17\frac{1}{2}$  (see page 208)

one, the body is too big for the mind; with the other, the mind is too small for the body.

As a consequence, the overgrown lad feels himself—as others also find him—out of his element wherever he is. He is already so huge that he can no longer be treated like others of his own age; at the same time he remains so immature and simple that he cannot, as yet, be associated with those of his own size. With every one he feels mismated. Other disabilities are apt to accrue from a growth that is too fast and too uneven—a loss of muscular delicacy, a visible awkwardness and unwieldiness, and an inner sense of personal discordance. He is a machine whose parts do not fit. His arms and legs are growing more rapidly than his body and his trunk more rapidly than his brain. His nervous system becomes unable to cope with his ungainly limbs; he lurches and flounders like a seal on a rock. This general clumsiness becomes most marked between the ages of twelve and fifteen, since it is towards puberty that the largest spurts of growth take place. In class the quick-growing boy may now be as tall as his master. At home he may tower above his parents. In the street and in the playground, his increasing bulk will confer a domination over his fellows that he has not yet rightly learnt to use; he becomes the bully of his family, the terror of his tinier school-mates, or the ringleader of a knot of mutineers. In all the situations of his life he brings the force of a full-grown adult to support the impulses of a half-developed child.

Naturally enough, against the overgrown delinquent the commonest complaints are of damage and violence. Persons are injured, property is broken, household furniture is smashed, sometimes to show his power, sometimes from a sheer miscalculation of the energy that is put forth. There are, however, many other ways, more subtle and less flagrant, in which defiance and the enlarging sense of independence may express themselves. The boy becomes not so much dangerous or destructive as difficult to manage: "beyond parental control" is the stereotyped description. In most of these cases the characteristic offense is running away from home or school. Often there has been no open rupture, no outward sign of dissatis-

faction that might explain to the puzzled parent the unexpected flight. The prompting is from within. There is a sudden yearning to escape from all confinement—to seek a wider scope for superabundant strength in the open country or at sea. The growing body becomes restless, hungry for the freedom, the fresher air, the active exercise of a natural out-of-door life: the narrow walls of the school, the home, or the office seem to afford it barely space enough to stretch. So to be hemmed in and cramped, becomes intolerable. And at length the lad runs off to enlist, to join the navy, or to emigrate to some distant land.

*Females.*—With girls this condition operates in a different manner and to a less disastrous degree. Many of my female cases bear records of having been overgrown romps and tomboys while at school and burly hoydens and viragoes in their later years. But, with most of them, bodily over-development goes hand in hand with sexual over-development; and the aggressive behavior is nature's own safety valve for surplus energy of another sort—for the stirrings of turbulent instincts quite as much as for sheer animal strength. In three cases, however, the physical size and vigor seemed definitely associated with, and possibly the outcome of, a general virility of type. Two of them, girls of fifteen and sixteen respectively, came under my notice for violent conduct. They affected the style and manner of masculine hobbledehoys. Each professed a profound disdain for the opposite sex; but cynical acquaintances were not wanting who averred that the opposite sex had first shown an equal scorn for them. Both were at last convicted of common assault—the first having made a fierce attack upon a lad of her own age and size, the second upon her mother; there could be little doubt that the mere consciousness of their exceptional power was something of an incitement to exploit it for aggression as well as for defense. The third, a young giantess of seventeen years of age, made a practice of dressing as a man and of indulging in manly adventures; she was at one time even reputed to have been a member of a male gang of bank-robbing bandits. Of sex delinquency there was no sign or suspicion; and the physical characteristics



proper to her sex were but slightly marked in her and had been exceedingly slow in developing.<sup>11</sup>

### 3. Adolescence

In the normal physical development of the healthy boy or girl the most critical period is that of puberty. And the connection of this time of change with juvenile delinquency is commonly demonstrated by charting a growth curve, as it were, for human crime.

Table XIII shows the age at which a large and typical sample of English prisoners were first convicted. Figures for habitual offenders and for prisoners of the star class are given separately. Prisoners of the star class—persons, that is, not previously convicted but now in prison for some serious offense—commit their first (and often their only) crime for the most part between the ages of twenty and thirty-five, with a maximum not very pronounced, at about the age of twenty-three. Habitual offenders receive their first conviction much earlier: over 50 per cent are sentenced before the age of twenty; 14 per cent before the age of fifteen. The sharp rise in the numbers soon after puberty is shown graphically in Figure 11,

---

<sup>11</sup> Disturbances in physical growth, whether towards excess or towards inferiority and whether accompanied by irregular sexual development or not, are doubtless in part related to functional derangements in the glands of internal secretion. In particular, the apparent inversion of sex characters, both bodily and mental, is attributable, so far as it is primary, to a derangement of this kind—to an over-activity, perhaps, of the adrenal cortex, or more probably to a general lack of balance between the endocrine glands as a whole. To this point I shall recur in discussing the appropriate treatment (page 221).

In relation to the cases described in the last paragraph of the text, it is instructive to recall that many women murderers are noted to have been of masculine appearance and proportions. Sarah Chesham, to pick but one notorious example, a woman who poisoned her husband and several children, including her own, is described as having been "a man in general build." Lombroso, too, distinguished a virile type of female offender—considering her rarer but more ferocious than the born male criminal (see *The Female Offender*, trans. by W. D. Morrison: esp. Chap. xii). Healy, however, considers that general physical over-development, so long as it is unaccompanied by over-development in primary or secondary sex functions, has little to do with delinquency in girls, far less than with that of boys; and with this my own figures agree.

TABLE XIII.—AGE AT FIRST CONVICTION

Age	(1)	(2)
	Habitual Offenders (2204) Per cent	First Offenders (682) Per cent
5	0.8	—
10	13.5	—
15	39.0	4.7
20	19.8	21.0
25	10.8	14.1
30	7.0	12.0
35	3.2	12.5
40	2.6	12.9
45	1.5	6.9
50	0.9	5.1
55	0.5	3.7
60	0.3	4.8
65	0.1	1.6
70	0.0	0.7
Total	100.0	100.0

and appears so disproportionate as to suggest the intervention of some special factor. It is curious to observe that, with these ingrained offenders, the curve of first commitments closely resembles the curve for the age incidence of many illnesses—for instance, measles, scarlet fever, enteric fever, and pulmonary tuberculosis. It is almost as though crime were some contagious disease, to which the constitutionally susceptible were suddenly exposed at puberty, or to which puberty left them peculiarly prone.<sup>12</sup>

<sup>12</sup> Goring's data (*The English Convict*, p. 201, Table 7) are the best available for this country and have here been used. The inference he draws is that, as in the incidence of scarlet fever and analogous diseases, so in the case of crime, "some constitutional proclivity," manifesting itself at the earliest opportunity in those most intensely endowed with it, "is the primal source of the habitual criminal's career" (p. 214). A more detailed analysis of the data shows that sex offenses increase rapidly at 15 years; damage to property at 20 and again at 35; stealing, burglary, and violence to the person at 20; and forgery and fraud not till 30 or 40.

The curve for enteric fever is taken from the age distribution of 8,689 cases received in the Metropolitan Asylums Boards Hospitals from 1871-93 (quoted by K. Pearson, "Skew Variation in Homogeneous Material," *Phil. Trans. Roy. Soc. (A)*, Vol. CLXXXVI, p. 390); the curve for tuberculosis is added from data given by Reginald Thompson,

From figures such as these the natural conclusion has generally been drawn. "Adolescence," says Stanley Hall, in his classic work upon that subject, is preëminently the criminal age, the age when most vicious careers are begun."<sup>13</sup> At this period, he believes, nearly every child passes temporarily through a

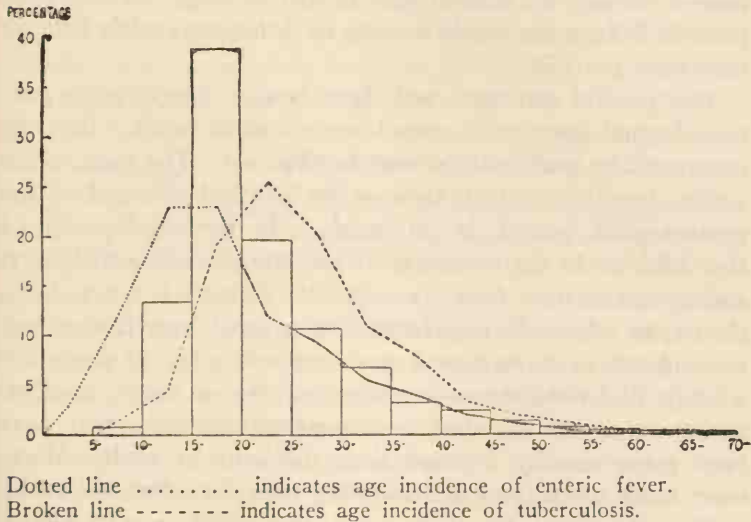

FIG. 11. AGE AT FIRST CONVICTION, 2,204 HABITUAL OFFENDERS

delinquent phase. Savage instincts now emerge for the first time; the hereditary traits of the family, whatever they may be, emotional, immoral, or neurotic, now make their first appearance, and long years are needed before they can be educated and controlled.

Were such a generalization valid, two corollaries would ensue: first, the common event of adolescent crime should be viewed, not as the inevitable outcome of original wickedness or of a

---

*Family Phthisis in Relation to Heredity and Life Assurance*, p. 22 (Table I; 4,000 cases). More recent figures for these maladies (e.g., for phthisis, *L.C.C. Annual Report (Public Health)*, 1922, p. 11, or, for enteric, Metropolitan Asylums Board, *Annual Reports*, 1919-20 to 1923-24, Table II, Ages of Enteric Fever Cases notified in London) show an altered and a flatter distribution doubtless due to the successful measures lately taken to combat these diseases.

<sup>13</sup> *Adolescence*, Vol. I, p. 325.

rascality that needs prompt punishment and nothing more, but as an incidental consequence of natural physiological changes; secondly, much crime in later life might be simply the after-effect of a habit begun during adolescence and might often have been avoidable had the first manifestations been rightly treated during this crucial and formative stage. Thus, most juvenile delinquents would seem to be delinquents solely because they were juvenile.

This general statement and these further interferences contain, beyond question, a sound ingredient of truth. But one or two minor qualifications must be observed. The most recent studies have shown that, both on the physical side and on the psychological, growth is continuous. In the development of the child, as in the evolution of the world, nature makes no sudden starts: *nihil facit per saltum*.<sup>14</sup> Puberty is not a sharp, abrupt, or wholesale transformation, a rapid leap from youth to manhood, as at one time it was supposed to be. It marks but a single ill-defined stage—in many respects, no doubt, a culminating stage—in the slow developmental processes that have been going steadily forward since the hour of birth. Moreover, much of the new and alarming behavior, often shown by children from the elementary school towards the age of fifteen, and popularly attributed to some mysterious inner revolution overtaking them at that date, is due very largely to one simple circumstance: it so happens, as we have already remarked, that the age of puberty is the age of leaving school; it is the age when most young people pass from the discipline of parent and teacher, cease to be pupils and turn into wage-earners, take their first cold plunge into the wider sea of industry, and so are tempted to affirm a social as well as an economic independence of all who have hitherto trained and governed them.

There is a further ground for caution in arguing from the published figures. That the number of first commitments shows a vast increase at this period is not to be denied; but it by no means follows that the time of the first commitment marks the time of the first offense. Many convicted at adolescence prove

<sup>14</sup> Tissot, *Discours de la Vie* (1613), quoted by Linnæus, *Philosophia Botanica* (1736), sec. 77.

on nearer inquiry to have had behind them a long record of petty faults.<sup>15</sup> It is the expanding freedom of the youthful offender, together with his greater responsibility, his greater physical and mental powers, and his wider radius of dangerous action that obliges his parent or employer, or whatever authority may take the first step, to hale him at last to the police court. In only 2 per cent of my cases was adolescent instability alone sufficiently well marked to form the principal cause of crime.

Another point needs even greater emphasis. The phase of physiological transition is far more variable in its time of onset, as it is far more protracted in its total duration, than appears in general to be assumed. The mental manifestations precede the more obvious physical manifestations by at least two years. The physical manifestations themselves emerge at different ages in different individuals. They may occur at almost any time between thirteen and seventeen in boys, and between twelve and sixteen in girls; in exceptional cases, earlier or later still. Nor is it possible to regard the renovation as complete until another four or five years have elapsed. Indeed, the whole cycle is not over until the young adult is married and has founded a home and a family of his own. The exceptional cases are the most critical. It is, as we shall see in a moment, chiefly when these various dislocations, physical, psychological, and social, have been unusually premature or unusually delayed—most of all, when one element is hastened or retarded, while the rest are

---

<sup>15</sup> Only a few days ago I was asked to examine a lad of eighteen, convicted as a nominal "first offender" for stealing and trying to sell a motor car. I observed to him that it was singular that a theft of this kind should be his first. He explained that he had recently been discharged from his last place for taking a pound note. I asked, had he ever stolen before. He admitted that once or twice at school he had been in trouble for stealing half-crowns. "When did you begin to steal?" "When I was nine I used to take pennies from the mantelpiece, and mother never found out." And before that, as I later discovered from the log book of the infants' department, he had been robbing other children of their luncheons at the age of six; while his mother avowed that he had started to snatch sugar and cake as soon as he could reach the table on tiptoe.

Most investigators could quote instances of this kind, wherever they have sifted and winnowed, not mere official statistics, but the private history of the offender himself.



not—that the ordinary accompaniments of adolescence conduce to a criminal slip.

What, then, are the main features of the child's development at the period of this crucial change? They arise from one central fact. It is now that the growing human animal at last achieves what has been so long postponed, sexual maturity. Of itself, this physical achievement confers new possibilities of wrongdoing. A fresh capacity is a fresh temptation. When the baby's vocal organs are first matured, he is all for babbling and gurgling; when his legs are strong enough and their movements come under control, he is all for crawling and clambering; and, in the same way, at the age when the sex organs ripen an inclination towards sexual misbehavior tends very naturally to arise. There is, however, a general belief that this primary physical change carries with it many other mental consequences more remote, more indirect, and more widespread. Most writers upon the subject have assumed that a vast number of inborn mental tendencies dormant during childhood awake and become suddenly active about the time of adolescence. It is a view not easy to substantiate. And the best contemporary opinion now leans towards a simpler theory. All these apparent transmutations of character it regards as no more than the secondary results of the one fundamental change. Directly or indirectly, they are mainly due (so far, of course, as they are generated from within and not from without) to the perfecting of the sexual glands and organs, together with the marked invigoration of the related impulses, that inevitably ensues.<sup>16</sup>

However they are to be explained, the chief concomitants of the prime physiological change may be broadly summed up under two heads: there are, first, a gradual retardation and an ultimate arrest in the growth of inborn intelligence; there is,

---

<sup>16</sup> The former view is elaborated in the monumental work of Stanley Hall on *Adolescence* (1905) and has been accepted by the majority of his followers. The latter and simpler hypothesis is briefly defended by McDougall in his *Social Psychology* (eighteenth edition, 1923: supplementary chapter on "The Sex Instinct," pp. 421 *et seq.*). The reader should also refer to Ernest Jones' illuminating article on "Some Problems of Adolescence," *Brit. Journ. Psych.*, XIII (1922), pp. 31-47.

secondly, a transient increase of temperamental instability, arising from or leading to a corresponding reinforcement of all the primary instincts and emotions. The child is, in this metamorphosis, born, as it were, anew; he passes through a stage of second babyhood. After he has put off the grub and before he can put on his self-supporting wings, he resolves himself into a sort of human chrysalis, into a strange intermediate creature, neither child nor grown-up man. The schoolboy he has left behind him. Adult perfection—with all its higher powers of intellect and stronger powers of self-command, its richer experience, its wider social outlook, its fuller domestic independence, its more intimate contact with outer reality—he has not yet reached. And he seems first compelled to relapse into, or at any rate to resume (though, of course, upon a different scale), much of the primitive selfishness, impulsiveness, and fancifulness of the earliest years of infancy. In this there is something more than a mere figurative generalization. Again and again I have found in individual cases that the traits which the mother recollects as having characterized the child during babyhood—temper, jealousy, incontinence, petty sexual practices—are revived for a time during the pubertal stage. Thus, if the boy is father to the man, the baby is father to the boy.

In what way these various mental changes may lead to adolescent delinquency should be sufficiently clear from their general nature. Their special mode of working will be examined at greater length when we come to deal with the particular intellectual and emotional qualities themselves.

#### 4. Periodicity in Girls

In girls the onset of puberty is specifically marked by the appearance of monthly crises. With many, if not with most, the periodic processes that now begin, though in themselves physiological, appear to occasion, or at least to be accompanied by, mild but far-reaching disturbances of mind. The pain, the discomfort, the bodily lassitude, with some for the time being quite acute, must tend, like every other derangement in the sense of bodily well-being, to augment irritability and to lessen self-control. The custom of concealing and even ignoring the con-

dition magnifies rather than reduces the uneasy state of fretful tension and is of itself conducive to paltry deceit. In my small group of analyzed cases I found that the psychic disturbances connected with menstruation appeared as a factor in delinquency among about 4 per cent of the girls (Table XII). Theft—more often theft from impulse and opportunity than enterprises calmly planned—is the commonest offense occurring during these days; at such times, and at no other, many young women of a neurotic and unstable disposition take to shoplifting and to larceny of that seemingly motiveless kind which the popular journalist styles kleptomania. In some, however, a fuller study will disclose that the robberies are not exclusively confined to those occasions, but that they are then performed with greater carelessness and so found out with greater ease.<sup>17</sup>

But, on the whole, I am inclined to attach less importance to the actual period of indisposition than to what may be called the pre-menstrual phase. In the premonitory stages the dominating mood is one of excitement rather than depression. Among unstable persons instability is then often at its highest; and in many the local irritation and congestion, together with the more general effects of the organic processes upon the system as a whole, conspire unmistakably to magnify sexual

---

<sup>17</sup> In eighteen young girls, aged fourteen to nineteen, kept under observation for six to seventeen months and selected because of the frequency of their misdeeds, I found that, of the total number of demonstrable thefts (amounting in the aggregate to eighty-seven), as many as 34 per cent occurred during what may be termed the menstrual week; and, on an average, only 22 per cent during each of the other three weeks. In three of these cases more than half the thefts were committed during the seven days in question; in five other cases, taken from a longer list of 200 girl delinquents, more than three-quarters; in two, there seemed an approach to a fortnightly rhythm, with an interposed disturbance perhaps connected with the so-called *Mittel-Schmerz*. I can find but two instances in which stealing never occurred except during these short spells of stress. In the most conspicuous examples, the thefts conformed to the general characteristics of so-called pathological stealing; and the actions proved upon analysis to be a kind of substitutional delinquency, affording an outlet or relief for some unconscious sexual conflict, during a time when sex excitement was increased and when physical health and moral self-control were appreciably impaired. But in other cases the delinquents turned out to be prostitutes; and the motive was merely to obtain money, food, or other necessities, which could not, during these recurring intervals, be procured in the usual way.

feeling. With some, a similar mood of overexcitement recurs, as soon as the period is over. In both the pre-menstrual and post-menstrual phase the commonest delinquencies are downright sexual misconduct and adventures arising immediately out of, or manifestly substituted for, this particular impulse—as wandering, running away, and staying out late at night. In some of these latter instances, the mere physical exercise seems to afford relief; in others, roaming along the streets and accosting strange men not in fact but in fantasy bestows a partial satisfaction. Outbreaks of temper are exceedingly frequent, and may be marked by physical violence and even by homicidal and suicidal threats or attempts.

The point to be kept firmly in mind is this. From one girl to another the amount of physical and mental derangement varies enormously; and the family convention or school code which suits the majority may bear most oppressively on the exceptional sufferer. Extreme cases, however, nearly always show other peculiarities, more permanent and more fundamental, such as general physical weakness, general emotional excitability, or over-development or under-development in sexual characteristics of a secondary rank. Irregular and unusual disturbances, both physiological and mental, are most marked during the first twelve or eighteen months of puberty, before periodicity has become properly established and placidly accepted as a matter of routine; but they are liable to recur under stress during later years—for example, after a disappointed love affair, or when hopes of matrimony are being given up. It is in these unsettled phases and cases that delinquency is most likely to be provoked and is most in need of special consideration.<sup>18</sup>

---

<sup>18</sup> In some, an occasional delay in the monthly cycle may issue in the same mental and moral disturbances that are shown in the pre-menstrual phase by those who are more regular. It is to be remembered, too, that girls who indulge in sexual malpractices are apt to become worried about possible consequences when menstruation is overdue. Such worries may be entirely unfounded and based solely upon conscious or unconscious fantasies. Groundless fears of this sort are particularly common in young persons who have been misinformed on sexual matters or who have invented wild theories of their own; and will at times persist irrationally after correct enlightenment has been given.

5. *Premature Puberty and Other Forms of Non-Correlation in Development*

The clearest instances of adolescent crime occur when physical development is unusually early and mental and moral development retarded or delayed. The principal danger thus arises, not from adolescence as such, but from a lack of harmony and correlation among the various lines of change. The peril is greatest in the girl. In my group of two hundred, I found premature or excessive sex development among nearly 10 per cent of the girls and only 4 per cent of the boys. It was chiefly among the former that this condition appeared as a major cause (see Table XII).<sup>19</sup>

(1) In the typical case, all four of the main characteristics of adolescence—size and strength, figure and form, sexual functions, and sexual consciousness—are developed prematurely together.<sup>20</sup> In these respects, the girl suddenly finds herself already a woman, while in self-control, in worldly experience, and in common sense she is still little more than a child. The connection between female delinquency and this uneven development is as clear as it is common. The provocation may arise both from within and from without. Outwardly these over-developed maidens are dangerously alluring to the eye of the opposite sex; inwardly they are apt to accumulate an unusual store of sex emotion pent up within themselves.

The resulting offenses, once more, are generally sexual. But, as most observers have remarked, there are, among these precocious cases, several subtypes—the active, the inactive, the

---

<sup>19</sup> For methods of assessment see Appendix II, note on standardization of measurements.

<sup>20</sup> As a rule, the early appearance of puberty, as marked by menstruation, is correlated with a "vigor and vitality in excess of the average," in fact, with a premature development both in general physique and in the secondary characteristics of sex: this is the general conclusion of those who have made a special study of the subject (see, for example, W. R. Williams, *Journ. of Obstetrics and Gynecology*, I, 1902, iv, p. 400; and A. E. Giles, *Menstruation and its Disorders*, Medical Monograph Series, 1901). In passing, it may be added that premature development and over-development are found with increased frequency in cases of epilepsy and hysteria.



bold, the shy, the sanctimonious; and their transgressions differ accordingly. Some are brisk and animated creatures, fast in action and forward in behavior, ready to dive into any daring enterprise. Others are inert and easygoing sluggards, limp, lazy, and languorous, dreaming all day on cushions like a cat and prowling round in the evenings to steal or solicit because they are too indolent to work. Others, of a sturdier mold, battle for long against their own temptations and desires, and when at last they give in, take to venial crimes of a substitutional type. With a few, the show of struggle and restraint is little else than self-deception and hypocrisy; they will soothe both themselves and others by unctuous prattle about religious conversion and spiritual reform, but no sooner have they proclaimed their penitence than they sink back into their old immoral ways.

(2) Often, however, the sexual precocity is neither complete nor widespread. There may be a lack of harmony among the pubertal characteristics themselves. There may be accelerated growth in general physique—in height and weight and strength—with no early ripening in sexual functions or sexual characteristics to correspond; this we have already considered, and have seen to be, at any rate in girls, less serious. But, on the other hand, there may be at times an over-development in sex functions with no equivalent growth or change in general physique; and then, particularly with girls, the disaccord may prove disastrous.<sup>21</sup> I have several instances upon my lists where the absence of plain external signs has deceived teachers, friends, and even parents; and where, nevertheless, puberty<sup>22</sup> has al-

---

<sup>21</sup> In boys premature sex feeling without corresponding physical development is less important for consideration. At times it may lead to autoerotic or homosexual practices. Such is especially the case with premature adolescents who physically are still weak and childish and with inmates of industrial or other residential schools where the moral tone is low. When puberty is postponed, with or without delay of general physical development, the boy sometimes suffers from a neurotic bashfulness that may grow into an antisocial attitude; where, in addition, the secondary sex characteristics are markedly delayed, and the youth retains a childish and an effeminate appearance, he may become the prey of perverts of his own sex.

<sup>22</sup> As evidenced, to be explicit, by early menstruation. The average

ready arrived too soon, bringing in its train precocious sex feelings and premature sex impulses and thus leading to misconduct at an age unusually young. Lapses so occurring, however rare, are nevertheless instructive: they remind us that the awakening or the non-awakening of sex functions and sex feelings cannot be always inferred from a mere superficial glance at outward and visible signs.

(3) Finally, there may be a marked over-development of the secondary and more general sex characteristics—an enlargement of the hips and bust, and a general rounding of the contour—with no premature onset of the physiological functions. Such persons, as a rule, still carry with them an unusual amount of sex emotion, or at least of sex consciousness. And it is, indeed, the development of these more general sex characteristics, both physical and mental, that seems to be attended by the greatest risks of all.

### Treatment

It might be supposed, since development and its disturbances depend, in their essential nature, on physical and physiological processes, that therefore any moral faults connected with irregular development might be treated with success by physical or physiological means. And certainly where the normal growth of the body is seriously affected, search should first be undertaken for any morbid or material cause. Of disease and of the pathological weaknesses that may result from bad feeding, insanitary conditions, and irregular habits of personal hygiene, I shall speak in the following chapter. These more obvious and more directly harmful agencies can, as a rule, be attacked upon well-recognized lines. In cases more obscure, the investigation needed may prove intricate, arduous, and prolonged.

---

age of the first onset (among girls native to this country) may be put at fourteen or a month or two later (see Appendix II). Menstruation before the age of twelve may be regarded as abnormally early. Foreign girls in a northern land—Jewesses and Italians, for example—though naturally disposed to earlier puberty, nevertheless suffer from some of the disabilities of the precocious natives.

### 1. Glandular Treatment

Where such abnormalities can be traced to no clear external or pathological cause, one special region of the inquiry deserves attention—the functions of the glands that regulate growth. Already from the laboratory table a sidelight upon this subject has begun to shine. The glands of internal secretion—the thymus and the thyroid, the pituitary, the adrenal, and the reproductive glands—may, as recent work has plainly shown, greatly accelerate or retard the general development of the body, when their own activity or equilibrium has been upset: they have a specific influence over pubertal changes; and upon the development of the mind, and above all upon the emotions, their effect may be no less profound. Hence they stand in a twofold relation to the facts and phenomena of crime. At times the secretory derangement is the outcome of a definite disease. More frequently the lack of glandular balance seems simply due to an unusual but still normal activity in a perfectly natural function, and may be regarded as developmental rather than as morbid. Until recently, the most striking triumphs with gland therapy have been those obtained in early infancy; but of late many cases of disturbance during puberty have yielded to surgical or medical treatment directed against the over-active organs. Several authentic instances are now upon record where delinquency, connected primarily with unusual deviations in physical development, has, it would seem, been combated with success by administering glandular extracts or by extirpating the glands themselves. At present, such treatment is little more than experimental. To surgical measures, where no visible illness exists, public sentiment in this country is likely to remain opposed. To the milder methods of gland therapy, no such objection could be made. And there can be little room for doubt that the biochemistry of the future will illuminate the whole subject of crime and directly minister to its cure. For the present, however, with the majority of these cases, treatment along social and psychological lines must remain more urgent and effective than treatment by medical or surgical means.<sup>23</sup>

<sup>23</sup> Two children were brought recently to my notice, both of them

## 2. *Continuation of Training and Supervision into the Adolescent Period*

Always it is to be remembered that, like most examples of non-correlation in development, such anomalies may be but transient. Time and the slow readjustments of spontaneous growth may right the trouble of themselves. The overgrown boy does not necessarily turn into an adult giant; nor the undeveloped stripling into a pigmy. And where criminal tendencies have not declared themselves before adolescence, there is every hope that their appearance may prove nothing but a passing phase: for then it may be reasonably argued that they are due simply to the stress and strain of the adolescent period, not to the natural constitution of the child. It is, therefore, the phase, rather than the individual, that calls for specific measures; and every precaution must be taken lest the way he is treated should aggravate, instead of relieve, the difficulties of his condition. Puberty, we have seen, is not a break but a climax. Hence, what is wanted is not so much a sudden and special care for the adolescent as such, but a continuous prolongation of the training, moral, social, and intellectual, which the child has enjoyed from infancy upwards and which now is abruptly cut off. Hence a gentle and more gradual weaning, an easier introduction to his new responsibilities, and an early and more fitting preparation for the inevitable change, before the change itself takes place.

---

dull and dwarfish little thieves—the one eleven years old, the other twelve and a half. They were not defective enough to be designated cretins, but showed well marked signs of hypothyroidism; each was treated with thyroid extract; and both not only improved in general physique, but also grew out of their apathy and criminal ways. Signs of thyroid excess, however, are far commoner among my cases, particularly among girls at puberty, than signs of thyroid deficiency: the change in disposition, the increased excitability, the nervousness and peevishness which are recognized accompaniments of an over-active thyroid gland, may easily lead to criminal conduct. Where a slight visible swelling in the neck, staring protuberant eyes, flushes, tremor, rapid pulse, and perhaps a history of Graves' disease in the family, combine to suggest such a condition, medical advice should at once be sought.

On the temperamental changes said to follow extirpation of the sex glands see page 306, and Healy's comments referred to on that page.

### 3. Change of Environment

During the period of uneven growth, there are many simple and temporary expedients that may serve to bridge the passing crisis. The boy who, by some freak of physical development, is exceptionally big or exceptionally tiny for his age, should be put where he will feel his anomaly as lightly as possible. During school years, it is often well to place him in a class with children of his own size, rather than with those of his own age or of his own intellectual standing. In after life, he should be found an occupation where his peculiarity will be an asset and a help, not an embarrassment or a ground for ridicule. One lad of sixteen, a small but well-proportioned dwarf, working in a factory with boys ten inches taller than himself, had been scoffed at, nagged at, and hooted at till he was utterly unmanageable; no sooner was he sent as a page to a hotel and put into a gold-laced uniform than he recovered his self-respect and lost all his desperate ways. The big, overgrown youth who looks a man before he is fifteen often snatches the remedy into his own hands and goes off to find himself a job or perhaps to join the army; he may overstate his age, but his subsequent career is often so successful that one is tempted to suggest that physique, rather than age by the almanac, should be the qualifying factor. Many who go abroad take well to a rough life upon a ranch; others, remaining in this country, still do best upon the land. So long as such a lad is kept at home, the parents must be warned that they cannot reasonably expect to dominate a huge fellow, however young, as though he were still a small child of normal build. Should serious offenses, however, already have been committed, or criminal habits have taken root, it may be wiser to remove the boy to some reformative establishment where he may be fitly trained and firmly piloted through the period of unequal growth, and kept under close watch and discipline until his intelligence has once more caught up with his physique and the unsteady stage of puberty is over.

### 4. Institutions for Older Delinquents

Whenever there is a record of grave and repeated delinquencies, committal to such a place will be all but unavoidable. It



is, or it should be, the only proper course. Unfortunately, as we have seen, when the child is too old to be committed to a reformatory, it may be difficult to find any other place to send him to, besides the jail. There are, however, two recent and contrasted types of institution, of a somewhat experimental character, suited by reason of their age limits specifically to the adolescent offender, namely, the Borstal institution and the juvenile colony. Each calls for a brief description here.

(a) *Borstal Institutions.*—In 1902, at the convict-prison near Borstal, a village on the banks of the Medway, a number of convicted lads of sixteen and upwards were collected together, to be trained apart from adults under a new, stringent, industrial régime. Seven years later this establishment was converted into a fresh type of penal institution, a half-way house between a prison and a reformatory.<sup>24</sup> There are now five such places, four of them holding in all just over a thousand boys and one holding about a hundred and fifty girls.<sup>25</sup>

By the Prevention of Crime Act, 1908, persons sent to a Borstal institution must be between sixteen and twenty-one years of age; they must be detained for a period of one to three years; and the court, before passing such a sentence, must be satisfied that "the character, state of health, and mental condition of the offender, and the other circumstances of the case, are such that the offender is likely to profit by such instruction and discipline," and that, "by reason of his criminal habits or tendencies, or association with persons of bad character, it is expedient" that he be sent thither. By an amending clause in a

<sup>24</sup> The suggestion originated out of the *Report of the Departmental Committee on Prisons* (1895), to which the reader may usefully turn. A concise account and criticism of the scheme will be found in *English Prisons of To-day* (1922), edited by S. Hobhouse and A. F. Brockway, especially Chap. xxvi, pp. 410–39. It is, however, but just to remember that the authorities themselves were by no means blind to the existing defects, and that since Mr. Alexander Paterson was appointed a commissioner of prisons a couple of years ago, with special reference, it is stated, to alterations in the Borstal scheme, many of the strictures formerly urged have become rapidly out of date.

<sup>25</sup> The figures are based on the average number of inmates during the year ending March 31, 1923. As reckoned by the number of available cells, the total accommodation is nearly double those figures (*Report of the Commissioners of Prisons for 1923-24*, Appendix IV, p. 77).

later Act,<sup>26</sup> boys and girls can be dealt with under the Borstal system only if they have been previously convicted, or have failed to observe the conditions of their probation.

The system had, together with special advantages, many obvious defects. The two great merits of the plan lay in the segregation of the "juvenile adult" from the adult fully grown and the strong emphasis placed upon physical and industrial training and upon after-care; its greatest drawback was its rigor. In the terms of the Act, Borstal institutions were intended to be places for "detention under penal discipline"; they were, in consequence, suited primarily to offenders, physically hardy, and morally hardened, who were yet possessors of sufficient intelligence to benefit by instruction in a trade. The work, the training, and the discipline were too arduous for any but the strong and sturdy; the limp and the fatiguable, whether in body or in mind, were unable to respond to the régime. Critics arose who were quick to point out that, in spite of the great superiority of the new plan over the life of the ordinary prisoner, the opportunities allowed to the inmates for the exercise of self-dependence, judgment, and initiative were too slender; and that, for vigorous, high-spirited young people, still in the restless adolescent stage, confinement under "penal discipline," within the walls of a prison-like building, was a course too repressive to be truly efficacious. During the past few years, however, and in the face of economic hindrances, large improvements have been made. The more restrictive regulations are disappearing: the officers are to wear plain clothes instead of uniforms; the boys' establishments are being broken up into houses, after the plan of the English public school; each house is to have its own house master, its own house colors, its own prefects, and its own teams; and a scheme of grades has been introduced with increasing privileges—the most coveted being the permission to smoke accorded to boys in the "special grade."

But, to the mind of the psychologist, there is one inherent defect—the drawing of a clean lower limit at sixteen. Between

---

<sup>26</sup> Criminal Justice Administration Act, 1914, Section 10, subsection (1) (b).

the adolescent of sixteen and the adolescent of fourteen there is less difference than there is between the latter and the child of twelve. And in any case it is physiological and mental age that should count rather than age reckoned by the calendar. If a few after-histories can be trusted, it would seem that the persons most likely to profit by the system are youths who are but little beyond sixteen, physically and mentally fit, drifting towards a confirmed career of crime, yet with no record of previous restraint in an industrial school, reformatory, or prison. In accordance with the intention of the Act, no casual offender from impulse, passing lapse, or sudden passion is a suitable candidate for such a place. It may be added that, with almost all the cases for which Borstal treatment is considered worth while, the maximum rather than the minimum sentence should be imposed. Where long-standing habits have to be broken and fresh habits to be permanently built up, the element of time is essential. Should sufficient reformation seem to have been accomplished before the three years are over, the Prison Commissioners will exercise their power to release or license out.

A vital feature of the scheme is the work of the Borstal Association. A quasi-official body, subsidized by the Treasury,<sup>27</sup> this society receives the youths and girls on their release from the institution and becomes responsible for their after-care. The task of finding for every inmate some fitting occupation is held to begin, not upon discharge, but upon committal—a sound principle, of wide application. A "character book" is kept for each, and any item which may assist in studying his requirements is entered in it—not always, however, upon a very scientific basis. Both industrial training and, where necessary, elementary education are adapted so far as possible to individual needs.<sup>28</sup> According to the latest *Annual Report of the*

---

<sup>27</sup> Prevention of Crime Act (1908), Section 8.

<sup>28</sup> All inmates now work their full eight-hour day from the time of their arrival, and instruction has been removed to the evening. A psychologist may be permitted to wonder whether a progressive grading of the working hours might not prove the better mode of discipline, and an educationalist to inquire whether a few hours' teaching at the end of a hard day can yield solid educational results or afford the teacher the needed opportunity for knowing each lad as an individual.

Borstal Association, of the six hundred Borstal offenders who have now been at liberty for two or more years, 75 per cent of the boys and 85 per cent of the girls have not come into conflict with the law since their discharge.<sup>29</sup> It is clear, however, that there is room for a more scrupulous sorting of the young people so committed: for the same *Report* points out that only 5 per cent of the entrants have attainments above the level of Standard IV, and that many of them are "physically and mentally barely employable." Upon the careful selection of appropriate cases and a thorough elimination of the unfit, the success of the whole project must ultimately depend.<sup>30</sup>

(b) Juvenile Colonies.—The opposite extreme of absolute freedom is, or was, provided by the experimental colonies established in this country, after the pattern of the George Junior Republic at Freeville, near New York. Such have been the Little Commonwealth founded in Dorsetshire, the Sysonby Village Colony financed by the Fellowship of Reconciliation and established near Melton Mowbray,<sup>31</sup> and the Training Colony organized in Berkshire for young women from London charged with solicitation. Each of these colonies was designed as a working community rather than as a school community. Indeed, in a voluntary establishment, the provision of a school

---

<sup>29</sup> *Borstal in Nineteen Hundred and Twenty-four* (Borstal Association, 15, Buckingham Street, London, W.C.2, 1924), p. 5.

<sup>30</sup> Quite recently, the detached prison for boys at Wandsworth has been adapted to serve not only as a remand home for those awaiting sentence and a jail for those convicted, but also as a reception center to decide the suitability of individual cases for training under the Borstal plan. Each child is medically examined and psychologically tested. By this means it should be feasible to keep out the unstable and the sub-normal; capacity for education and trade instruction should be determinable; and the type of institution, and the class of labor, for which each adolescent lad is fitted, should be discoverable beforehand.

<sup>31</sup> I was invited to carry out psychological examinations for this second institution, and during short periods of residence at Sysonby had the pleasure and privilege of forming a close acquaintance with the inmates, under the natural conditions in which they lived. As the reader will gather, several of the descriptions in this book relate to cases at this colony. To the superintendent, Mr. F. R. Hoare, and to the secretaries I am deeply indebted, both for notes upon many of the children and for permission to publish records, letters, and photographs collected in the course of this work.



is almost an insuperable obstacle. Hence, if only in virtue of the law for compulsory education, the minimum age for residents must usually be fourteen; and the majority will be a year or two older. The juvenile colony is thus primarily adapted for the adolescent, and it is the adolescent in turn who are best fitted for such a scheme.—

The story of the first junior commonwealth in England has often been told. Fresh from a similar experiment in America, the enterprising founder came one day to the Tower Bridge Police Court in the East of London to secure the nucleus of his contemplated colony. In the anteroom he passed three girls struggling fiercely with a policeman. One struck the officer a vicious blow with her fist, and all were using language far from appropriate to the precincts of a court. They were systematic shoplifters well known to the police; but so skillful had they been in their transactions that evidence clear enough to convict them was hard to procure. Before the magistrate, their posture of defiance was fully maintained. "Don't be a fool," cried the biggest to the smallest, who was whimpering: "stare 'em out." In spite of the misgivings of the magistrate and of the police, who thought the girls too rough and truculent, all three were secured for the venture. Two constables and a police matron were told off to convey the young colonists safely down to Dorset. Their new patron, however, declined all help and left the girls to reach the train themselves. As he puts it, "They did not escape, because there was no one to escape from." To their new life of liberty they settled down with a will, and hidden virtues quickly came to light. A fortnight later, when the magistrate surprised them by a visit, they bore him off to see their garden, and brought him back again, arm in arm, with flowers in every buttonhole. His first question was, "Whatever can you have done to make those dreadful hardened criminals into children so delightfully natural?"<sup>32</sup>

---

<sup>32</sup> For the description of these early beginnings and original aims I am indebted partly to conversations with the superintendent and other members of the managing committee, and partly to the account printed in Mr. Clarke Hall's book, *The State and the Child* (pp. 145 *et seq.*).



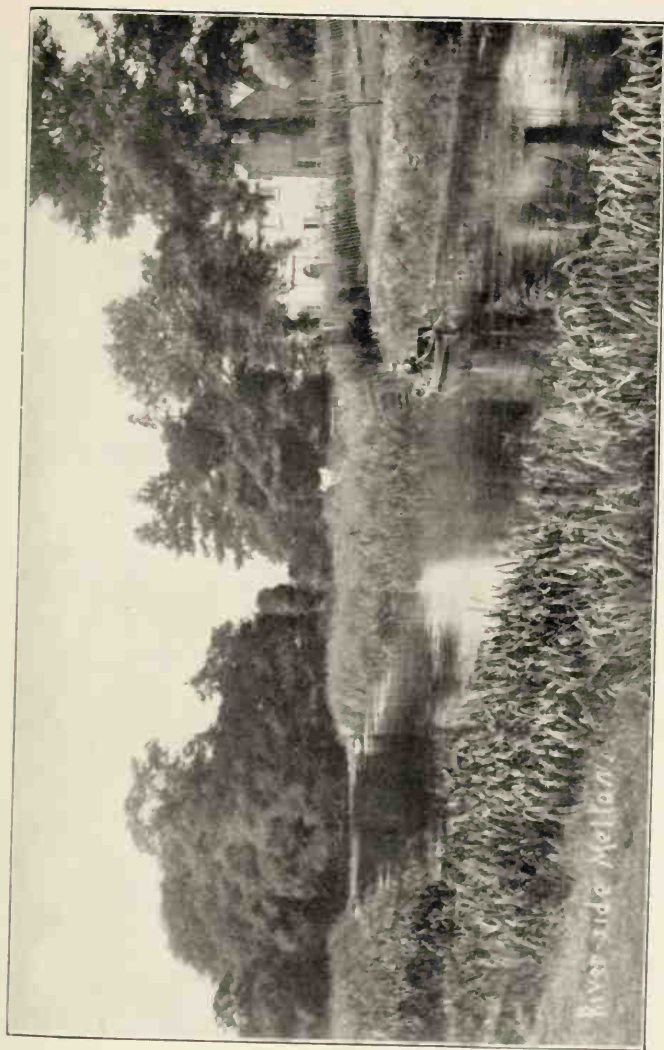

FIG. 12. SYSONBY VILLAGE COLONY FOR ADOLESCENT DELINQUENTS



FIG. 13. SYSONBY; LONDON BOYS AT THE COLONY

*Reproduced by permission of Mr. F. Hoare, formerly Superintendent of the Colony*

It was the paradoxical view of the founder that the true secret was to do nothing—to remain passively in the background, trusting to the free, untrammelled nature of the child himself, leaving it without encumbrance or restriction to work out little by little a spontaneous change of heart. What he aimed at was an insulated community, involving normal family life, youths and girls living in the same home with a grown-up-house mother, working together under the unimpeded operation of practical economic laws and at liberty to organize whatever form of government might suit their simple ideals. Freedom, not captivity, was the keynote of the place.

The grounds comprised a farmhouse with its cottages situated on a two-hundred-acre farm. There came at length to the commonwealth upwards of sixty youthful colonists. The members were encouraged to discuss amongst themselves every problem that arose and to frame their own decisions. Quite spontaneously they started legislative meetings of the citizens, and presently set up their own juvenile court, presided over by one of themselves. In this way "the tremendous energy of the adolescent, employed formerly to upset law and order, was gradually used in reorganizing order and in maintaining law." When each child is free to exploit his own ideals, whether good or bad, the bad ideals become automatically eliminated, since, being self-contradictory, they can produce no satisfying results. "By that simple process of elimination"—granted, we must presume, sufficient inborn vigor and intelligence—"the good is left."<sup>33</sup> Both this experiment and the later one at Melton Mowbray have been hampered by lack of funds and by checks of various kinds. Each has now come to an end. It is to be ardently hoped that in the near future similar colonies may be set on foot. The principles embodied have already influenced the aims, the methods, and the discipline in ordinary reformatories of the more conventional type. But nothing can take

---

<sup>33</sup> *Op. cit.*, p. 159. Mr. Clarke Hall—himself a magistrate who has sent many cases to the colony—adds that the bestowal of the Home Office certificate and grant on this new type of reformatory for boys and girls together "is surely one of the most remarkable triumphs as yet achieved by any social or penal reformers" (p. 164).

the place of these voluntary ventures; nothing seems so well suited to the social needs of the adolescent youth and girl as a free republic of their own.<sup>34</sup>

(c) Prison.—Many adolescent offenders, however, are too dull in intelligence or too unstable in temperament to be fit either for a Borstal institution or for a free self-governing colony. Unfortunately, too, these make up a large proportion of those whose juvenile offenses are the first premonitory omens of a career of habitual crime. For them no suitable institution is at present to be found. The only place for the grave offender is the jail. It is, however, universally agreed that the common practice of imposing a short sentence of imprisonment upon delinquents of this age is valueless alike for reform and for deterrence, and often brings more harm than good.<sup>35</sup> The new prison for boys at Wandsworth, with its special regimen, to some extent fills the want. But there is a pressing need for some specific type of colony or institution adapted to those who, whatever their chronological age may be, are mentally but little more than children. Institutions of at least two kinds seem requisite / first an institution for adolescents whose weakness is primarily one of intelligence—the extremely dull; secondly, an institution for those whose weakness is one of temperament or character—the highly unstable. As we shall find later, many boys and girls who during their school years should have been certified as mentally defective and sent to a special school, cease to be so certifiable towards the age of sixteen. For these a reformatory or Borstal institution is ill-adapted;

---

<sup>34</sup> An account of these principles, as forcible as it is suggestive, and based upon concrete experience, will be found in Mr. Hoare's paper on "Principles of Discipline and Self-government: An Experiment at Riverside Village," *Report of the Sixth Annual Conference of Educational Associations*, 1918, pp. 230-34.

<sup>35</sup> So recently as last year (the year ending March 31, 1923), 2,987 lads, of whom 53 per cent had not previously been convicted, and 337 girls, of whom 46 per cent had not previously been convicted, were received after conviction into the ordinary prisons of the country (excluding Borstal institutions). 1,663 lads were sentenced for a month or less; and of these, 40 per cent were committed to prison in default of paying a fine for some relatively trivial offense. (*Report of the Commissioners of Prisons for 1923-24*, pp. 13-16.)

for their primary defect, being innate, is incurable. With the unstable, the defect, although more troublesome, has not this hopeless permanence, since, as we have seen, their instability may be mainly a secondary consequence of the phase of adolescence itself.

##### 5. *Fines and Supervision*

Many of the offenses of the adolescent youth, however, are too paltry to entail committal to a residential institution: they are purely technical and imply no moral turpitude but merely a disregard of police regulations. Even in cases more serious, if the offender has never committed an offense before the time of puberty, there is, as we have seen, a reasonable likelihood that, provided a fair chance is given to him and to his better nature, provided evil influences can be removed and no deeper resentments are implanted by the efforts of an ill-timed justice, he may spontaneously recover. At this age, a theft, a blow, a burst of temper, a spasmodic attempt to run away from home, may be less ominous than it might be in a younger child: a single slip or two may be the accidental outcome of a transient instability, or of the unsettling effects of exchanging the old control for an unaccustomed freedom.

Unfortunately, although most delinquents making their first appearance in a police court are young persons of sixteen or thereabouts, there is yet no period of life for which the law provides so few appropriate modes of treatment. For the punishments devised for the adult such a youth is still too raw; for the educative treatment devised for the child he is already too old and seasoned; and to meet a mild offense almost the only practicable penalty—the simplest, the commonest, and, judged by results, the most salutary—is the imposition of a fine (the taking of recognizances may be classed as a sort of deferred or contingent fining). Upon the value and limitations of fining I have touched above. Here it may be added that, by the Criminal Justice Administration Act of 1914, not only must an offender be given at least seven days to pay his fine, should he desire such a respite, but also, if between the ages of sixteen



and twenty-one, he may be placed under surveillance until it is paid in full.<sup>36</sup> This additional provision contributes materially to the success of the present system of fining, since the probation officer or whatever person may be appointed by the court to supervise the lad will not merely see that, little by little, the fine at last is paid, but correct any minor maladjustments making for crime.

#### 6. *Female Adolescents*

The growing girl is a harder problem and a few additional suggestions seem requisite for her case. As we have seen, it is her physiology rather than her physique that generally gives rise to trouble. And whether, as statistics seem to indicate, the over-developed adolescent girl is in fact more prone to sex offenses than the over-developed or adolescent boy, she is cer-

---

<sup>36</sup> Section 1, subsection (3). Other clauses in this Act, tending to reduce the needless imprisonment of the young and of the poor, are those which allow the magistrate to substitute for a short sentence of imprisonment either a day's detention within the precincts of the court or one to four days' police custody in a suitable place. Owing to the war, it is perhaps too early to gauge the effects of these provisions. Much good, however, may in the long run be anticipated. "It is expected that, as a consequence, lads will not be imprisoned except for such serious offenses as will enable the court to pass a sentence of sufficient length to allow of real reformation of character being effected" (*Annual Report of Borstal Committee of Bristol Prison, 1917*). The Prison Commissioners emphasize especially the importance of the Act of 1914 for preventing the development of a criminal class: "Since the beginning of this century, commitments to prison in the case of what are known as juvenile adults have diminished from 12,178 to 3,663. We have, in former reports, expressed the opinion that still more might be done in the direction of saving these young persons from the stigma of imprisonment by liberal and generous use of the alternatives which the law now provides" (*Report for 1915*). Since this statement was made the diminution has gone on at a much slower rate (see footnote 35, page 230); and the Commissioners, Chaplains, and Governors of prisons are still deploring the harm and futility of short sentences of imprisonment (see *Reports for 1922 and 1923*).

When detention in custody is unavoidable, juvenile adults should be placed in a separate establishment where there are no adult prisoners. Remand homes should be provided which have no connection with the jail; and everything should be done not merely to remove unnecessary degradation, but to provide a better industrial training: hardly any of the local prisons contain good workshops with machinery and equipment for teaching a trade.

tainly in greater need of special safeguards. What lines should be followed must be, for the most part, obvious.

(a) *Physical Exercise.*—Hard work and physical exercise have always been counseled as a means of chastening the instincts of the flesh. Bodily activity—pushed if needful, to the point of fatigue—will help not only to use up superabundant vitality, but also to relieve the general restlessness that is inevitable when the animal spirits of youth are too summarily repressed. Yet, in many, mere outdoor exertion may tend to augment rather than to diminish physical feeling and excitement. Jeremy Taylor, among his “remedies against unchastity,” gave first place to “bodily labor.” He adds, however, a caution: “he that goes about to cure lust by bodily exercises alone shall sometimes find them instrumental to it and an incitation to his sudden desires.” So at the same time he wisely recommends: “If thou beest assaulted with an unclean spirit, trust not thyself alone; but run forth into company whose modesty may suppress, or whose society may divert, thy thoughts: for this vice is like camphire and evaporates in the open air, being impatient of light and of witnesses.”<sup>37</sup>

(b) *Supervised Social Recreation.*—Company, therefore, should be encouraged, and places for companionship should be accessible where girls can mix with boys and with each other, not in isolated pairs, but openly and in numbers, under the general eye. It is chiefly in their leisure hours and in their evening recreations that girls of an active type encounter their temptations. To furnish attractive forms of amusement, to provide harmless mental pursuits and higher intellectual interests as an outlet for self-activity and an aid to self-refinement, is everywhere imperative; and with girls, far more than with boys, tactful oversight will, as a rule, be indispensable. Such simple social training as is afforded by clubs, parties, and dances properly controlled, suggests itself as the most convenient and appropriate means.

(c) *Segregation.*—With the lazier members of this group more difficulty may be experienced. Naturally enough, it is

---

<sup>37</sup> *The Rules and Exercises of Holy Living* (1656), Chap. ii, sec. ii.

the aggressive that are brought forward most frequently for removal; but it is the inert who are the most subject to danger and are, in their passive way, the more dangerous themselves. For many Healy is inclined to advise a course of asceticism under medical direction. How far this would provoke the further perils attendant on repression—the neurotic or quasi-neurotic by-products with which psycho-analysts have made us familiar, may seem a little doubtful. In secret, many of these loose and languid precocities become “tempters of the opposite sex, purveyors of disease, and spreaders of vicious knowledge among their friends and casual acquaintances”<sup>38</sup>; and with extreme cases of this kind, if only to protect society, segregation must be advocated even perhaps at the risk of discomfort and of neurotic developments in the individual. Within the girl’s original environment success can rarely be looked for. Even when the parents are roused to the need of more efficient control, there still remain the old, habitual promptings which the mere presence of old acquaintances, old resorts, and old associations generally, must inevitably evoke. Moreover, since the condition is sometimes hereditary, the girl’s home frequently contains other examples of the same over-sexed constitution. For her, therefore, the home may be the last place in which she can be left with security.

Segregation, however, does not necessarily mean confinement in an institution. Often it is possible to find a private family or a quiet household removed from the enticements of a city life where the girl may be shielded from too free an intercourse with any who are likely to mislead her or to be misled. But whether inside or outside a recognized establishment, seclusion is seldom efficacious unless prolonged. Before the girl is twelve, signs of prematurity may appear; and the late and lagging characteristics can hardly catch up, if indeed they ever do so, before she is eighteen or nineteen. This means removal for no less than six or seven years. Few institutions in this country are willing to keep a girl so long. But in every case, no

---

<sup>38</sup> Healy, *loc. cit.*, p. 248. The whole of Healy’s discussion of the subject, in Chapters iv and xi of his book, should be attentively read by the practical student.

matter what course in the end be taken, the great essential is to tide the girl over this critical stage in her development until her own mind and character are sufficiently formed to supply strong internal resistances to whatever temptations may arise from within or from without.<sup>39</sup>

(d) *Marriage*.—Early marriage is often advised, and sometimes issues satisfactorily. *Nubat illa, et morbus effugiet.*<sup>40</sup> But, if the match is arranged solely and deliberately as a solution for this particular problem, disaster, not relief, is likely to ensue.

### 7. *Religious Influences*

The influences of religion can occasionally claim remarkable reforms with adolescent cases. "Now indeed," as the *Pilgrim's Scrip* declares, "is the Blossoming Season, the hour of Spiritual Seedtime."<sup>41</sup> Among offenders of a younger age than this, except for a few who were precocious and bright, I have seen no real response to a spiritual approach.

To enter into the psychological nature of religion and of its mingled influences is hardly possible in a volume such as this. I shall revert to the subject, therefore, in no other place. Not that I undervalue its profound potentialities. Were religion, as has been held by some, no more than "morality touched with

---

<sup>39</sup> Most countries have made the experiment of setting apart at least one home or institution specifically for immoral girls. By immorality, however, is generally understood a history of illicit sexual intercourse: the stock official phrase—a euphemism which is no euphemism, and should long ago have been abandoned—is "fallen women." To draw the line at this simple point is to mistake experiences for tendencies. Immorality is a mental state: and, as such, is to be diagnosed by mental rather than by physical signs. The child's future outlook depends, not on the actual occurrence of a single physical lapse, but upon the purity or impurity of her own thoughts and feelings. In the past her condemnation has too often been pronounced after receiving not a psychologist's, but a gynecologist's, report. Whatever else may have happened to her, if the girl's mind remains still unpolluted, there can be every prospect of recovery. *Mens impudicam facere, non corpus solet:* it is not a condition of the body, but a habit of mind, that makes a woman a profligate.

<sup>40</sup> "Let her wed and her complaint will vanish" (Galen).

<sup>41</sup> George Meredith, *Richard Feverel*, Chap. xii, "The Blossoming Season."

emotion," a psychologist who believes in the supremacy of emotional forces over human conduct would still be bound, if for no higher reason, to acknowledge the beneficent effects that may be produced by religious teaching, even upon the brutal, the dishonest, and the depraved; and his experience, if at all prolonged or penetrating, must testify that again and again the possibility is turned into a fact. One principle, however, the psychologist may be suffered to affirm: religious influences, like every other, should be adapted to individual needs. One child responds best to an imaginative appeal; a second, of sterner mold, is swayed more by ideals of austere renunciation and self-sacrifice; a third is moved most by a personal presentment:

*Qui Mariam absolvisti,  
Et latronem exaudisti,  
Mihi quoque spem dedisti.*<sup>42</sup>

It is perhaps with the sensuous adolescent girl that the spell of religion is most potent. The effect is not always so lasting. At times to substitute religious feeling for sexual feeling is merely to displace one gush of sentiment by another; and the temporary conversion is so hollow at the core, so hypocritical in its nature, so ruinous in its swift collapse, that the final outcome may be far worse than the first state of unsophisticated sin.

With the boy a corporate form of worship and a public form of service—a band of a hundred singing hymns together with a Salvation Army gusto—this is the spirit that comes home to him best. Heart-to-heart talks and the language of the Bible class he takes as an insult to his manly years. And any exhortation to a private devotional life can but convince the needy offender that "religion" (to borrow the phrase of one of them) "is not his line." "How," he will ask, "can he pray and meditate in a twelve-foot bedroom, surrounded by four rowdy occupants?"

With almost all delinquents, boy or girls, rich or poor, it is the positive rather than the negative aspects of religious teach-

---

<sup>42</sup> "Thou, who hast pardoned the Magdalen and the thief, hast given hope to me" (*Dies Ira*, xiii).



ing that should chiefly be enforced. If a direct reference to such things is necessary, virtues and not vices should most of all be dwelt upon. For the rest, bad habits like intemperance and unchastity are better depicted, not as horrible iniquities, or as sins against some high theological code, but simply as hygienic follies—faults which, persisted in, will stop the child from keeping himself physically and mentally fit: indeed to set a boy training with others for some athletic event will often be a far better preventive against over-indulgence than any amount of lecturing on the Christian duties of abstinence. Always the quiet example will be much more effective than the eloquent sermon, and the indirect method will yield the richest fruit. In too earnest a religious zeal there are risks as well as benefits, and the majority of older delinquents are least likely to be antagonized when moral effort is placed before them, not as essentially a form of self-repression or as a sign of saintly piety, but rather as the harmonious culture of all sides of human nature, each in just proportion to the rest.

## CHAPTER VI

### PHYSICAL CONDITIONS: PATHOLOGICAL

They have other faults, easily incident to those who, suffering much from debility or pain, think themselves entitled to whatever pleasures they can snatch.

SAMUEL JOHNSON.<sup>1</sup>

*Frequency of Physical Defects.*—There are many ancient maxims which declare that bad behavior is a token of good health. *Puer robustus, puer malus*, says the Latin. “Healthy child, wayward and wild,” says the Cornish woman. Nor is it to be denied that a high pressure of animal vitality is responsible for many pardonable offenses among vigorous boys and for much serious misbehavior among full-blooded adolescent girls. This we have already seen. As a general rule, however, the young offender of good physique and resistive constitution seldom comes back again in after years as an habitual criminal.<sup>2</sup> Most repeated offenders are far from robust: they are frail, sickly, and infirm. Indeed, so regularly is chronic moral disorder associated with chronic physical disorder that many have contended that crime is a disease, or at least a symptom of disease, needing the doctor more than the magistrate, physic rather than the whip.

---

<sup>1</sup> *Life of Pope* (Works, ed. Nimmo, p. 336).

<sup>2</sup> The practical corollary is obvious. Paltry offenses, such as playing football in the streets, and all first offenders involving a simple breach of the peace can, in most cases, be adequately and more appropriately dealt with outside the precincts of the court. To bring such minor matters before the magistrate is to stamp an unmerited disgrace upon the mild offender and to minimize the gravity of subsequent appearances for more serious crimes. The Scottish investigators found that in the course of a single year 422 such petty offenders were solemnly charged before the Juvenile Court at Edinburgh for transgressions which could have been handled far more suitably by a police superintendent or the child's own guardian. (See their recommendations on this point, *Report, loc. cit.*, p. 22.)

The frequency among juvenile delinquents of bodily weakness and ill health has been remarked by almost every recent writer. In my own series of cases nearly 70 per cent were suffering from such defects; and nearly 50 per cent were in urgent need of medical treatment. It is to be remembered, however, that children coming from those districts and those social classes in which delinquents are preponderantly found are far more subject to disease and deformity than children from healthier areas and superior homes. A comparable control group is again essential as a check. In London I find that defective physical conditions are, roughly speaking, one and a quarter times as frequent among delinquent children as they are among non-delinquent children from the same schools and streets (see above, Table III, p. 51).<sup>3</sup> In either group they are a little commoner among girls than among boys; but it is among boys that they appear somewhat more frequently as major causes of crime. In about 10 per cent of the boys I have examined and 7 per cent of the girls, some illness or bodily infirmity seemed the principal source of the child's faults. These percentages are not high. The detailed findings are given in Table XIV; throughout it will be noticed that, though common enough as an accessory and aggravating influence, physical defect is comparatively rare as a sole or predominant cause.

The actual conditions observed are for the most part mild physical weaknesses and irritations—*anemia*, chronic *catarrh*, swollen glands, tonsils and adenoids, headache from diverse causes, and malnutrition of every degree. The few major or precipitating factors are, as a rule, either diseases and disorders involving the nervous system—as *chorea*, *epilepsy*, and the after-effects of *encephalitis*—or defects of the special senses—as partial deafness and imperfect vision.

---

<sup>3</sup> The findings of the ordinary medical inspections both in London and throughout the country generally are that approximately 40 per cent are "defective and in need of medical treatment" ("The Health of the School Child," *Annual Report of the Chief Medical Officer for the Board of Education*, 1921, pp. 42-3. My detailed figures, however, differ somewhat from those published in the usual medical reports in that I have evidently attached far more importance to malnutrition and to catarrhal conditions and far less to dental decay (see Table XIV, note 1).

TABLE XIV.—PHYSICAL CONDITIONS: PATHOLOGICAL

	DELINQUENT					NON-DELINQUENT		
	Boys		Girls		Average	Boys	Girls	Average
	Major Factor	Minor Factor	Major Factor	Minor Factor				
Malnutrition:								
(a) Slight.....	—	13.0	—	8.1	11.2	10.5	9.5	10.0
(b) Marked.....	—	4.1	—	2.7	3.5	3.0	2.5	2.7
Rickets.....	—	7.3	—	2.7	5.6	5.5	4.0	4.7
Dental defects <sup>1</sup> .....	—	4.1	—	5.4	4.6	4.5	4.0	4.2
Anaemia.....	—	4.1	—	6.8	5.0	1.5	3.0	2.2
Recurrent catarrh....	—	17.9	—	13.5	16.2	9.5	5.0	7.2
Enlarged glands, tonsils and adenoids..	1.6	12.2	—	6.8	11.2	10.5	13.0	11.7
Hyperthyroidism....	—	—	1.4	2.7	1.5	—	0.5	0.2
Tuberculosis.....	—	1.6	—	2.7	2.0	—	—	—
Pre-tubercular conditions <sup>2</sup> .....	—	2.4	—	4.1	3.0	2.5	0.5	1.5
Lung defects.....	—	—	—	1.4	0.5	1.0	1.5	1.2
Heart defects.....	—	2.4	—	1.4	2.0	—	2.0	1.0
Acute rheumatism....	—	4.1	—	5.4	4.6	0.5	3.0	1.7
Chorea:								
(a) Definite.....	0.8	—	1.4	—	1.0	—	—	—
(b) Suspected <sup>3</sup> ....	—	4.1	—	8.1	5.6	—	1.5	0.7
Epilepsy:								
(a) Grand mal....	0.8	—	—	—	0.5	—	—	—
(b) Suspected <sup>4</sup> ....	[4.1]	—	[1.4]	—	[2.0]	—	—	—
Encephalitis or meningitis.....	2.4	1.6	2.7	—	3.5	0.5	—	0.2
Syphilis:								
(a) Congenital....	—	—	—	2.7	1.0	—	—	—
(b) Acquired.....	—	—	—	1.4	0.5	—	—	—
Recurrent headaches.	—	6.5	—	12.2	8.6	2.5	5.5	4.0
Local irritation <sup>5</sup> ....	0.8	1.6	1.4	4.1	3.5	—	—	—
Defective vision:								
(a) Slight <sup>6</sup> .....	—	8.1	—	12.2	9.6	10.5	13.5	12.0
(b) Marked.....	0.8	4.1	—	10.8	7.1	8.5	9.0	8.7
Squint (marked)....	—	0.8	—	2.7	1.5	—	—	—
Defective hearing:								
(a) Slight <sup>6</sup> .....	—	3.3	—	4.1	3.5	2.0	5.5	3.7
(b) Marked.....	1.6	—	—	1.4	1.5	—	—	—
Defective speech....	0.8	0.8	—	—	1.0	0.5	—	0.2
Total.....	9.6	104.1	6.9	123.4	119.3	73.5	83.5	78.5

<sup>1</sup> Serious cases, such as involve pain, oral sepsis, or general ill health, alone have been included.

<sup>2</sup> Including suspected tuberculosis.

<sup>3</sup> Including mild or sub-choreic conditions.

<sup>4</sup> Including "psychic" and "masked" epilepsy. Diagnosis suggested by medical examiner, but unsupported by subsequent information. Figures not counted in totals.

<sup>5</sup> Pruritus vulvae, herpes præputialis, etc.

<sup>6</sup> For definition see Report upon Backward Children in Birmingham, pp. 19-20.

## I. GENERAL CONDITIONS

Let us consider the more general physical disabilities to begin with—the inevitable effect upon the sufferer of all ill health and of every abnormal bodily state without regard, for the moment, to its particular nature or its specific results.

1. Transitory Weakness

Poor health means poor control; and even a temporary physical weakness may be the occasion of a passing criminal lapse. We know, every one of us, from personal experience, what an effort it is to keep back our hasty impulses if we are a little out of sorts or a little run down. When health deserts us, courage is diminished, laziness increased, and the heated temper simmers over in perpetual peevishness or bursts out in some sharp blast of violence.

We are no longer our true selves  
When nature, being oppressed, commands the mind  
To suffer with the body.<sup>4</sup>

The youth whose work needs energy and application, whose business entails long hours and irksome drudgery, finds it harder than ever on these days of transient weakness to rise promptly from bed in the morning, to toil punctiliously from eight till six, to withstand the onset of fatigue, and to do all that is incumbent to gain a hard-earned living in an honest way. Those who are addicted to some habitual form of stimulant—whether of tea, tobacco, or alcohol, amusement, sentimentality, or sex—never give way to their pet vice with such facility as in some moment of mild prostration. Nor is the criminal exempt. The most cursory questions are enough to show that he yields more quickly than the rest of us; and the parallel histories of ailments and of crimes will often make it clear that the child's offenses were chiefly carried out when, owing to temporary ill health or transient weakness and fatigue, his moral control was at an ebb.

---

<sup>4</sup> *King Lear*, II, iv, 108-10.



## 2. Chronic Disease

Lingering maladies may have more lasting effects; for permanent weakness and prolonged indisposition react upon the mind in ways more complex and more various. Any chronic disablement is apt to breed a morbid sense of personal inferiority; and this in turn, as we shall see, may grow into an unreasoning grievance against all who have the good luck to be stronger and a resentful grudge against whatever powerful agency—parents, companions, society as a whole, the universe at large, or God—may seem to the suffering mind to have cheated it of its normal human birthright.<sup>5</sup>

The seeds may have been sown very early. From the outset the sickly child has probably enjoyed an extra share of sympathy and petting. Too fragile to work as regularly as the rest, he has failed to form brisk habits of industry and self-denial. All through life, from sheer lack of bodily stiffening, he has been unable to stand up against his fellows; as a consequence, he has been tempted, even while still a tiny infant, to fall back upon craft and subterfuge to conceal his failings and to compass his ends. Feebleness begets timidity; and timidity is the parent of deceit. The sly child is often the shy child. What he loses from want of health and strength he is prone to make up by stratagem and guile. Hence the truth of the moralist's epigram, *La faiblesse est plus opposée à la vertu que le vice.*<sup>6</sup>

In older years, bodily flaws and infirmities bear with unusual hardship on those who belong to the male sex and to the working class. The working man, just because he is a man and (in the narrow, physical sense) a worker, is expected to earn his living by the labor of his hands. Bone and muscle are his only stock-in-trade. A woman—and even a man, if he has the intelligence and position of a clerk or a shopkeeper—may, in

---

<sup>5</sup> Not all, of course, who are invalids become criminals as an inevitable result. The sense of inferiority, if consciously accepted, may simply lead the mind to patient resignation. In some, however, from its very bitterness, it may become wholly or in part repressed and act like a so-called complex (see Chapter XII); it is then that the illogical consequence of crime is most likely to arise.

<sup>6</sup> "The real antagonist of virtue is weakness rather than vice" (La Rochefoucauld, *Réflexions Morales*, CDXLV).

this country, despite some small delicacy of physique, still find an adequate livelihood; a man from the laboring classes who is so afflicted cannot. For a while he may lead a precarious existence as a casual laborer; but two alternatives are ever before him, the life of a pauper or the life of a thief. Out of work, out of health, with no settled home and no settled prospects, disabled, discouraged, and starved, these weaklings from the slums soon find no choice but the workhouse or the jail.

Under this general heading may also be placed one or two conditions, more special in their nature, yet exercising a widespread influence on health as a whole.

Nasal obstruction from adenoid growths or some similar cause is common among delinquents; and is often attended by a dull, nervous, and debilitated state. The history of such a child is much the same as that of the offender who is weak and backward generally: and more than one medical writer has reported a complete cure of the delinquency where the removal of adenoid growths was undertaken.

As many as 5 per cent of my cases have been designated tubercular. This does not always mean that active tuberculosis has been expressly diagnosed. Often there are reports of "consumption in other members of the family"; but in the child himself the ascertainable ailments are usually broncho-pneumonia in the past and chronic catarrh at the time of examination. He looks undernourished and white; and his muscular tissue is but ill-developed. Further, the offspring of tubercular persons are often themselves somewhat unstable; and frequently the needless apprehension, caused by too open a reference to the early deaths of relatives, fosters the philosophy of the short and merry life.<sup>7</sup>

---

<sup>7</sup> A reference to the published reports will show that, among children committed to certified schools, tuberculosis stands out as a cause of death and disability. During the seven years covered by the latest figures available, tuberculosis has been responsible for 40 per cent of all deaths occurring in Home Office schools and for 45 per cent of all discharges based upon medical grounds (*Home Office Report, 1923, p. 41*). Nor are these high percentages due solely to the privations of the war. For the two preceding years, 1912 and 1913—the earliest for which accurate statistics can be had—the figures for both deaths and discharges were but little below the foregoing.

These somewhat obvious points may be illustrated by a somewhat unusual case. Its peculiarity springs in part from the fact that the disability affected, not a boy, but a girl, and in part from the circumstance that the child evinced a singular insight into the mental processes behind her actions.

Olive I., a girl of fifteen years, attending a special school for the physically defective, was brought to me for incorrigible theft.<sup>8</sup> She was a gaunt, gawky, self-conscious-looking child. Her pallid face and purplish cheeks, suggestive at once of some cardiac affection, clashed curiously with her bright, tawny-colored hair. She labored, too, under some difficulty of sight; the large lenses which she wore with the black frames all askew, whatever they might do to other objects, magnified very strangely the staring eyes behind them; and, with her head poked inquisitively forward, she conveyed the impression of flattening her snub nose against the glass of her own spectacles. Her general manner, half defiant, half apologetic, was that of a person accustomed to contempt; and she seemed painfully and pertly aware that her queer looks brought little to commend her.

Up to the age of twelve, said her mother, she had been "a model child." She had then succumbed to rheumatic fever,

<sup>8</sup> *Age:* 15½. *Home Circumstances:* Father, ticket-collector on railway. Wages, £3 a week. Three clean and commodious rooms: rent 9s. Discipline somewhat strict and on the mother's part far from judicious; she is distinctly disposed towards faultfinding, and her complaints are not always well founded.

*Family History:* Father, healthy and intelligent. Mother, healthy but dull. A paternal aunt said to have died of heart disease, suddenly, but at an advanced age. One older sister (aged 17), a shop assistant, healthy, intelligent, and well-behaved.

*Physical History and Condition:* Whooping cough, measles, acute rheumatism (at 12½) with endocarditis, leaving chronic valvular disease of the heart (mitral): hands and face cyanotic. Marked hypermetropia, with intermittent squinting. Height, 163 cm.; weight, 47.2 kg.

*Intelligence and School Attainments:* Mental age (group tests) 15.5; (mental ratio, 103). Reading, 15.5. Spelling, 13.0. Composition, 14.0. Arithmetic, 12.0. Handwriting, 13.0. Drawing, 13.0. Handwork, 14.0.

*Temperament:* Somewhat unstable and sensitive, with marked tendencies to repression, daydreaming, and grudge formation. A little moody and unsociable; makes very few friends. Inferiority complex (see text).

and had been left with a heart organically diseased. On returning to her old class in the ordinary school, she found that she no longer had the vigor for sustained intellectual work nor the vitality to support fatigue. She seemed, indeed, more likely to appear at the bottom of her class instead of, as before, at the top. To escape this mortification she took to cheating, and being beyond the average for intelligence, was able to carry on without detection an elaborate system of deceit.

As soon as her bad health was noticed, she was transferred to a school for the physically defective; and here, since she was far quicker at her lessons than the cripples and consumptives, her wits and her time were but partly employed. She found intervals for brooding over her personal privations, and for scheming to get by furtive ingenuity what she could no longer secure by honest endeavor.

Her sister, two years older, had left school at fourteen. When Olive reached the same age, her parents heard to their vexation that, at a special school, a child must stay until sixteen; they began to mutter because she was an expense to them, instead of a source of income. Hoping she might be certified as sound, they took her to another doctor. The doctor, however, pronounced that she could not live to be twenty. The girl overheard his verdict; and, after a few days of piety and penitence (for she had always been devoutly disposed), she developed a sort of Promethean defiance of the Deity, resolving, like Mycerinus of old, that whatever might happen to her here or hereafter, she would make the most of the five years that remained. Her parents grudged her money; her older sister had wages to spend on sweets, and clothes, and evenings at the cinema. Olive, therefore, to obtain for herself the same enviable pleasures, began embezzling. A few weeks after, the sister appeared with a devoted male friend; Olive at once looked round for a similar companion. No one seemed to want a pale and peevish invalid. But by stealing from a sweet shop bags of chocolates and boxes of dates and figs, she managed to bribe a greedy pair of disreputable boys to take her to the park and to the pictures. The confectioner had his suspicions and imparted them to the parents. Challenged, but as yet unconvicted, Olive grew more

reckless; she proceeded to pilfer from other shops, but now with less skill and small success. Finally, when her sister came home one evening with a wrist watch, Olive coveted a wrist watch too. Her father at first promised her one for a gift at Christmas; but when her misdemeanors continued, he began to hint that the present was not justly deserved and could hardly be afforded; so Olive took the matter into her own hands and stole a three-guinea watch and wristlet from a jeweler's counter.

A theft so serious brought the intervention of the authorities; and at this point I was asked to examine her. The first step was to determine the exact condition of her health. I thought the family doctor too pessimistic, and seeing that the girl was already prepared for the worst, and perhaps for more than the worst, I agreed beforehand to her stipulation that the specialist should tell her without the smallest reserve what he thought of her chances of recovery. He declared, frankly enough, that though she might drop suddenly at any moment (particularly with her health now doubly reduced from the self-inflicted strain of the past few months), there was yet no reason whatever why with due care and attention she should not live a long, useful, and happy life. She rallied at once, like a condemned prisoner unexpectedly reprieved. Her conduct, as well as her health, began from that moment to mend. Nor was it hard, in the course of our many discussions, to set her quick mind smiling at the absurdity of her late anarchical views; and in a new heroic vein she bent herself to read the lives of great men who had also been great invalids—Pope, Johnson, Stevenson, and Spencer. For eight months she was excused from school, and sent for a holiday near the coast; and then, through the agency of an interested friend, she was apprenticed to a small firm of milliners—a trade that imposed no heavy tax upon her strength and afforded her at the same time an absorbing occupation, a sense of independence, and a little pocket money of her own. I watched her for six years; I believe she never stole again. The reform was attributable first of all to better health, together with the increased self-confidence and self-esteem that better health brought with it; and secondly, and



in no small measure, to her own intelligent perception that a career of delinquency could not, after all, make up for the disabilities entailed by her physical weakness or in any degree satisfy her wants as she had first assumed. To this conclusion, I believe, she herself had nearly come before I saw her; and I sometimes suspect her final flare of desperate folly was half deliberately designed to bring her disappointed struggle to a head.

## II. ACUTE ILLNESSES

### 1. Acute Illnesses Generally

The mental processes of this girl, or something not unlike them, can often be discerned in young children who are recuperating from one of the acute infectious fevers so common in early years—measles, whooping cough, scarlatina, or diphtheria. No definite disease may be left behind. Yet the patient's health may suffer lasting impairment. Whether at school or at home, the smallest effort or exposure may still be sufficient to bring on petty discomforts—headaches, weariness, fits of faintness, and the like. As a result, if only for the sake of self-defense, the habit of laziness and shirking grows overwhelmingly upon them. During lesson time they idle or play truant; after school hours, they mope or loaf. Those who think first of the body and next or not at all of the mind, consider them cured. Any excuse, however genuine, that is based upon feelings of exhaustion would be heard with cold indifference or evoke a scornful reproach for want of endurance and grit. And so, to escape exertion and avoid fatigue, their flagging strength protects itself by lying pretexts, which may or may not be accepted but at least preserve them from an imputation of cowardice or shamming.

There may be other results still more remote but no less deleterious. Unable to take an equal part in games with his fellows, the weakened child grows dreamy, solitary, and eccentric. And the empty hours supply occasions for harboring foolish fantasies and even improper thoughts and, later on, for concocting and for carrying out low and nefarious designs.

Often, however, the moral trouble only emerges after the boy is fully restored to vigor; hence, what I have said about general debility applies no longer. It is not the incapacity but the habit of non-exertion that is persisting. In cases such as these, one can often trace a history of spoiling and indulgence during the convalescent stage. Sometimes the child was an only child lovingly nursed at home; sometimes he was the only child in the hospital ward and therefore, naturally enough, the pampered pet of the nurses and the older patients. After his whims have been humored so long and so profusely, he may find himself suddenly back again, in a poor and overcrowded household, shouldering the little burdens of a slum child's life. And even if his stamina are now strong enough to support them, he still resents a return to the rough tasks and discipline that are the lot of the hardy boy.

With most young convalescents, it is character rather than physique that remains permanently enfeebled by the circumstances of their disease. The mental effects outlive the bodily. The resulting misdemeanors do not, as a rule, commence until the child has completely regained his original health and liveliness. Often his delinquencies seem provokingly mean, since he is singularly apt to turn upon the very persons who have denied themselves while he has been unwell. Sometimes they date from the first scolding or punishment that he receives. Sometimes, suggestively enough, they are precipitated by an illness in another: the fresh patient diverts the interest of parents, friends, or nurses; and the forgotten favorite is stung at once to jealousy. Thus, whereas with valetudinarians of the preceding class—with Olive, for example—it is the weak child who envies the strong, here it is the child that has become strong again who now covets the attention bestowed upon the sick. As a consequence, there may, to begin with, be a little fraudulent malingering, designed to retrieve past notice and affection. When all this fails, the child proceeds to a determined stealing of those good things—fruits, jellies, and sweets—which were his perquisite as a bedridden invalid, and are now being lavished on his ailing rival.

Treatment

Into the details of the medical or surgical measures appropriate to each specific ailment, this is not the place to enter. I can do no more than endeavor to lay down a few broad principles for the general treatment of those moral offenders who happen also to suffer from some physical defect.

1. Adequate Medical Attention as a Preventive.—The regular medical inspection and treatment of all school children, as a matter of routine, has already done much to forestall crime and misconduct during later life. But by some accidental circumstance the delinquent is often debarred from the full benefit of these proceedings. He may have been playing truant when the inspection was arranged. He may have kicked and screamed when taken to the hospital for the excision of his tonsils or the extraction of a tooth; so that the operation was never completed, and the trouble has been left untouched. He will be forever breaking his spectacles; his medicine he will refuse or forget; and every prohibition of the doctor he will in turn infringe. Yet, with the delinquent, it is especially urgent that any physical disorder that may impede school training or social success should be dealt with as early and as efficiently as possible.

To begin with, then, the mere fact that a sickly child is also a naughty child, must never shut him out from the sympathy and care due to all who are ailing. Too often, the needy parent will excuse herself from spending money on glasses, trusses, or prescriptions, on the ground that the child "doesn't deserve it." In reply, it may be needful to impress upon her mind that a weakness that is physical may itself be in part to blame for a weakness that is moral; and that the remedy may therefore be doubly worth the cost. To wait until the child complains of pain, or, worse still, until he suggests by his outward conduct the presence of some inner disorder (of which he himself may perhaps be wholly unconscious), is to wait until it is dangerously late, and to jeopardize his whole career.

2. Physical Deficiencies to Be Treated First.—When routine treatment has been neglected or postponed, any physical handicap should be the first point for attention. In every case

where physique and character are alike afflicted, whether the child has been brought into court or not, the initial step is to discover, and if possible to relieve, the physical disorder. To tone up the child's general health is often of itself enough to put strength into his moral fiber; and no form of psycho-therapy is likely to be effective so long as his physiological vitality remains unequal to everyday demands.

It is true that, in the production of delinquency, defective bodily conditions of a general kind play a subsidiary more often than a primary part. Nevertheless, it is impossible to say beforehand whether the mere removal of the physical drawback will not at once be followed by a complete reform. In any case, an approach that is purely or primarily medical is of itself a valuable asset. The attitude of the parent towards the child and of the child towards official justice is rendered far more favorable when this new standpoint is taken. The parent learns that the trouble calls not for scolding, but for sympathy; and the weakly youngster reaps the attention he requires with none of the hurtful effects either of an unintelligent sentimentality or a summary and unappreciative judgment. Further, parents and officials are alike reluctant to chastise, or even chide, an ailing child; and the child in turn is prone to make capital out of his immunity, or, if punished, to feel that a greater injury has been inflicted than he in truth deserves.

3. *Special Medical Examination for All Delinquents.*—"Every child charged should be carefully examined by an experienced medical practitioner before being brought before the court." This is one of the main recommendations of the report by the Juvenile Organizations Committee of the Board of Education.<sup>9</sup> The doctor, it is added, "would often give evidence that the child was suffering from some disease which tended to make the offender irritable, passionate, and at times perhaps hysterical, or even temporarily insane."<sup>10</sup> For such assistance, magistrates themselves are among the first to appeal. "A great defect," writes one of them, "in the English courts, as compared with the American, is the absence in the former of medical

<sup>9</sup> *Report on Juvenile Delinquency* (1920), p. 40, Recommendation 9.

<sup>10</sup> *Loc. cit.*, p. 12.

reports. . . . Without such a report, and without the means of acting upon it, children's cases cannot be fully and efficiently dealt with." <sup>11</sup>

Too frequently, as the pamphlet just quoted observes, "defects are only discovered in the case of children sentenced to a punishment which demands a medical examination, *e.g.*, birching, or committal to a reformatory or industrial school; and, even in these cases, the examination is made only after the decision of the magistrate has been given, and is sometimes so perfunctory that the defect is not noticed." <sup>12</sup> The medical examination

---

<sup>11</sup> Clarke Hall, *The State and the Child*, p. 56. An admirable report on the medical examination of children brought before the juvenile courts in Canada and the United States has recently been prepared by my friend and colleague Dr. F. C. Shrubbsall, and is, I understand, shortly to be published. From the little I personally was able to see and learn during a recent visit to those countries, I gather that, in their general character, such examinations, on the physical side, follow much the same lines as those carried out in the larger cities in Great Britain. The judges of the American courts, however, prefer to have a detailed and technical summary of the case set out before them, with the fullest possible recommendations, whether the conditions found have any direct relation to the offense or not and whether or not there is any likelihood of the recommendations being put into practice.

See also Appendix II, on the Psychological Clinic for Juvenile Delinquents.

<sup>12</sup> *Loc. cit.*, p. 12. The Scottish investigators similarly discovered "several instances of definite physical defect which did not always emerge at the court: such cases included defective eyesight, tubercular glands, hip joint disease, malignant growth of the jawbone, and two boys who were subject to fits" (Scottish National Council of Juvenile Organizations, *Report of an Inquiry into Juvenile Delinquency*, 1923, p. 26). They recommend that, at any rate for towns numbering more than 150,000, the services of a medical man, specially qualified and specially appointed for the purpose, should be available at juvenile courts, that appropriate cases should be referred to him before the decision of the court is given, and that, when advisable, such cases should be continued thereafter for medical observation and report. A like suggestion is put forward in the Home Office *Report on the Work of the Children's Branch* (1923), p. 12. I would go yet further. I would urge that a thorough medical examination be made, not of picked cases, but of all delinquent children as a matter of routine. Children brought before the court for some single, trivial, and technical lapse are hardly to be included in this category. But, beyond this obvious elimination of the merely technical offender, if the selection of the "appropriate cases" be left to a non-medical authority, then (as has been found at Birmingham) many of the most hopeful may be passed by; and, further, selection of any sort is apt to invalidate deductions from statistics so compiled.



carried out at the remand home is by reason of the requirements usually of a swift and superficial kind. The boy's height, weight, and vision are measured, and outstanding defects are sometimes noted. But the parent is seldom seen; and no provision is made for obtaining a complete physical history of the child. That he has at one time suffered from an exhausting illness like enteric fever, or from symptoms that suggest some constitutional weakness like rheumatism or epilepsy—these particulars and others of a similar import must be missed again and again.

The doctor appointed to assist the court should be one specially competent to deal with children. If the services of a psychologist are not also available, then the doctor should have some psychological qualification, and should possess an intimate acquaintance with mental as well as physical subnormalities—with delinquency, psycho-neurosis, and commoner defects and diseases of the mind. Above all things, he should be a man with the spirit of research. Every case is a problem for scientific analysis; and the whole field of his work is urgently in need of scientific exploration.

4. Ascertainment of Medical History.—Where it can be arranged, the parent should attend the medical examination, and the records of previous medical inspections should be to hand. There are many conditions which it is not possible to comprehend without a knowledge of the child's past ailments; and a word from the mother will often suggest or confirm a suspicion in the examining officer's mind. At present the presumption is that in cases of school age it is the business of the school authority to ascertain and report the physical as well as the intellectual condition of the offender. Where the representative of the education authority and the representative of the law work in close coöperation, this presumption serves well enough in practice. Nevertheless, the school medical officer reports only when specially requested, and the teacher, in sending his formal report, seldom alludes to medical findings. It may, indeed, be doubted whether, as a layman, he would be competent to do so.<sup>13</sup> A

---

<sup>13</sup> The medical cards are kept at the school and are handled by the teacher. But to teachers the professional abbreviations and the pro-

medical investigation, as well as medical examination, of each individual case, studied afresh from the beginning, is accordingly the ideal procedure. Points of importance, whether found at the special inspection or noted on the school medical cards, should, with due discretion, be passed on to the probation officer or other agency dealing subsequently with the case.

5. Importance of Minor Ailments.—Of the physical ailments found among delinquents, most, as we have seen, are minor ones. They are of that vague and trifling type which under ordinary circumstances are easily ignored or left to right themselves in the course of nature. To get the hospital or the relief agency to regard them with the full seriousness that in a delinquent child they undoubtedly deserve is sometimes difficult. And too often, with the praiseworthy purpose of sparing the child's reputation, the parent or care committee officer hesitates to tell the physician that there are moral as well as physical symptoms.

6. Convalescence.—With delinquents after-care and convalescence should in general be prolonged. Where a simple operation has been undertaken—for example, the removal of tonsils or adenoids—the operation of itself is not enough to return the child to vigorous health, unless an extended period of open-air treatment afterwards is arranged for: and with any who are in the least unstable, the period of recovery from illness is always a time when self-control is weakest. Those who have to deal with a young convalescent should recollect that he has a mind as well as a body; and that the former is often as seriously enfeebled, as delicate and as slow in restoration, and as much in need of gentle and patient handling, as the latter.

7. Removal to Country Homes.—Removal from home is nearly always helpful. With the facilities at present existing, to send the child to a convalescent institution or to a home by the sea may be one of the easiest measures to secure. Experi-

---

fessional handwriting which distinguish the doctor's entries are hieroglyphics that they can seldom decipher. This, sometimes, is perhaps as well. But it means that the teacher himself rarely attempts to communicate what has already been ascertained about the child's physical condition and history.

ence justifies its value. *Cælum non animam mutant*,<sup>14</sup> they say. Yet often a change of scene may work a change of mood as well as an amendment of health. And time after time a holiday in the country has proved a successful cure for crime.

8. *Hygienic Measures at Home.*—In a few cases, however, this step may seem unnecessary, or prove impossible to provide. Sometimes it should be sufficient to see, by constant visitation at the home, that hygienic measures are duly carried out. The mother should be taught that little things, like colds, carious teeth, exposure to damp or to fatigue, may have big consequences; and she should again be warned lest the obstinacy or carelessness of the child himself prevent him from getting or using needed remedies.

9. *Industrial Schools.*—Where the weakness is mild and general, and where, owing to the stubbornness of the child or the negligence of the parent, a hygienic regimen cannot be enforced at home, and where, too, the case does not justify or the funds do not allow removal to a private home, transference to a good industrial school in the country may prove, after all, the most effective measure. At such a school, many of these cases have, to my knowledge, been accepted with success. The regular hours, the wholesome food, the constant occupation act as a tonic to the physical system no less than to the moral.<sup>15</sup>

10. *Discipline.*—With delicate children corporal punishment should in general be dispensed with. It seldom corrects the misconduct, and by aggravating ill health and implanting a sense of injustice, may even make misconduct worse. Modern methods of discipline seek to develop an internal self-control rather than to impose restriction and authority from without. Such methods are needed most of all with the sickly delinquent.

It is possible, however, to be too tolerant as well as too severe.

<sup>14</sup> "In changing their climate they do not alter their souls" (Horace, *Epistles*, i, 11, 27).

<sup>15</sup> The Roman Catholic community has done an admirable work in providing special industrial schools for certain types of defect—for ophthalmic, for epileptic, and for crippled cases. Cripples who are Protestant may be received in the unique little colony at the Heritage, Chailey.

Formerly the physically defective and deformed were met with cruelty and ridicule; their disfigurements were viewed as earmarks of their spiteful nature—a nature which in point of fact their treatment was helping to produce. Nowadays the family cripple is usually the family pet, indulged so liberally and with such persistence that the need for self-discipline has never dawned upon his mind. What the weakling needs are not emotional methods but just methods, not sentiment but sympathy. Like every one else, he sometimes merits punishment, and punishment must sometimes be bestowed. In homes where no other form of discipline is understood, the suspension of all chastisement may have disastrous consequences. Occasionally the family physician is so imprudent as to warn the parent, in the hearing of the child, never to use corporal means. After this, whenever the child is rebuked, his first exclamation will be, "The doctor said you're never to hit me." In one case a young boy of eleven, supposed to be tubercular, was rapidly cured of his troublesome ways when I recommended just one reversal of this judgment. This, however, is hardly to be quoted as a universal precedent.<sup>10</sup>

11. Limitations of Purely Physical Treatment.—Finally, too much must not be expected from a purely medical or surgical approach. The mere presence in a young thief of a swollen gland or joint does not prove it was the swelling that forced him into theft. Medical writers in the past have been too prone to draw such inferences, assuming that the increased incidence of a particular defect is proof enough of its causative action, and prophesying that a little surgery is a certain remedy

---

<sup>10</sup> Sometimes it is the child and not the physician, who frightens the mother into withholding all punishment; and the same history repeats itself. I have recently had before me a boy, suffering from slight kidney trouble, where a long career of disobedience and defiance could be dated from a definite event. One morning, after the discovery of a small but somewhat irritating lie, the mother completely lost her temper, and the beaten child suffered, or simulated, a general collapse; the incident was ever afterwards held over the head of the would-be reprover, both by the child and by the fond and sheltering father, until all authority had been undermined. Once again, a single application of corporal punishment, inflicted under the eye of the family doctor, had a swift and salutary result.

for crime.<sup>17</sup> Their advice has been progressively adopted, but crime still abounds, and parents and public alike are at length growing skeptical.

Organic weakness only prepares the soil; it cannot plant the weed. Criminal conduct, like all other conduct, springs ultimately from the mind. Nor does the mere removal of a contributory condition inevitably remove its ulterior effects. The physical defect may have been triumphantly diagnosed and remedied, but in the meantime a mental habit may have been formed. Above all, it is to be noticed that those in whom bodily discomfort induces serious moral and emotional reactions are generally victims of a temperamental weakness as well as a physical. Both must be taken in hand if success is to be insured.

## 2. Illnesses Specifically Disposing to Nervous Instability

Several diseases are connected, or thought to be connected, specifically with tendencies to crime. These for the most part are affections that involve, as their common and conspicuous symptom, an increase of emotional instability. Three of them at least call for a brief discussion—epilepsy, encephalitis, and chorea.<sup>18</sup>

(a) *Epilepsy*.—The Italian criminologist, Lombroso, had a sweeping theory that every inborn criminal is essentially an epileptic. Epilepsy he looked upon as a far more comprehensive condition than it is generally supposed to be; he conceived it as a pathological state of the nervous system with many alternative manifestations—convulsive seizures in one patient, spasms of crime in another, and flashes of original genius in a third. Of the facts that he emphasized many are beyond dispute. It is

<sup>17</sup> America has suffered more than this country from these extravagant claims: the uniform successes that are sometimes said to have followed the extraction of impacted teeth or the excision of adenoid growths were no doubt genuine; but possibly suggestion played as great a part as surgery, and the impressiveness of the operator and his shining instruments worked a miracle that the operation alone could hardly have achieved.

<sup>18</sup> Other nervous conditions I shall touch upon later, when discussing those neurotic disorders in which mental causes and mental symptoms are more pronounced than physical (see Chapter XIII).



everywhere acknowledged that epileptics sometimes perpetrate impulsive acts of violence; that mental and moral aberrations, even apart from a history of fits, are by no means uncommon in the offspring of an epileptic stock; and that, in their strong emotionalism, in their peculiar egocentricity, in their ugly temper and obtuse discernment, in their wild irrational outbreaks, half automatic and half compulsive, criminals and epileptics are often curiously alike. These points of affinity are, indeed, suggestive. Nevertheless, epilepsy connotes a definite group of symptoms. It implies a sudden loss of consciousness, nearly always accompanied by convulsive movements and usually commencing with a sudden fall. If we need a name to embrace some more generic state—some widespread form of nervous instability, shared by many who have no such fits in common with those who do—then we must seek another term that will not beg the whole question.

True epilepsy is comparatively rare. Unless the patient is actually seen in a fit, the diagnosis even of the graver forms is difficult, and unless a full case history can be obtained, the diagnosis of the milder types must always be doubtful. Of my two hundred cases of delinquency two only suffered from *grand mal*, and in them the paroxysms of criminal violence, seemingly unprovoked, and forgotten as soon as they were over, could be attributed to some more general mental reaction (such as might naturally arise in any one afflicted with an incapacitating nervous malady), quite as properly as to true epileptic impulses or their so-called psychic equivalents. Like other neurotic persons suffering from an intermittent but disabling illness, the epileptic feels himself painfully different from his normal fellows; to get steady work or to earn steady wages seems all but impossible; hence, with his unhappy lack of nervous and emotional balance, he is doubly prone to nurse dangerous and resentful moods and to become hostile to the community that fails to support him.

Another half-dozen of my cases had been diagnosed usually by the family physician, as "masked" epilepsy, "psychic" epilepsy, or "suspected" epilepsy. But in only one of them was the diagnosis based upon the occurrence of recognizable epileptic

tendencies in the parental stock. Often the doctor himself, when pressed, admitted he was but stretching a generous theory to account for an apparently motiveless crime; nor was it hard, with a more penetrating search, to probe down to a different and a demonstrable cause.<sup>19</sup>

(b) Inflammation of the Brain or Its Membranes.—There is an allied condition to be found with some frequency at the present time among young delinquents in London. Encephalitis lethargica, known more familiarly as “sleeping sickness,” is an acute infectious fever, characterized by an inflammation of the brain substance and marked during the acuter phase, among other and more variable symptoms, by a prolonged state of somnolence or stupor. It is followed in most young patients by enduring after-effects, both bodily and mental, which in some points resemble the features of acquired or secondary epilepsy. The epidemics of 1918 to 1921 have left an aftermath of post-encephalitic invalids: and the presence of the condition in juvenile delinquents has been remarked by several observers.<sup>20</sup> Of

<sup>19</sup> Compare also the case of hysteria, with epilepsy in the family, described below (Flora S., Chapter XIII).

Healy's figures for epilepsy appear remarkably high. He finds that “of a thousand cases of young repeated offenders, 7 per cent are known to be definitely epileptic, and there is a question of doubt in a number of others” (*op. cit.*, p. 416; *cf.* also his table, *ibid.*, p. 147, where, however, cases of major epilepsy are unfortunately not kept apart from those of a minor and perhaps more dubious type). For the divergence several reasons may be conceived. Possibly epileptics likely to be dangerous are segregated in Great Britain with more success. Possibly a disproportionate number of cases having a history of fits were referred for that very cause to the Chicago clinic. Even with older and repeated offenders I should not have anticipated a proportion of one in fifteen from a random English sample.

<sup>20</sup> It is estimated that, in London, there are at present over two hundred school children who show serious disturbances of intellect or conduct as a result of this disease.

Among the innumerable articles written upon the subject during the last few years, the following are perhaps the more interesting to the student of juvenile delinquency: Paterson, “After-effects of Epidemic Encephalitis in Children,” *Lancet*, II (1921), p. 491; Burt, “Note on the Mental After-effects of Epidemic Encephalitis in School Children,” *Brit. Journ. Psychol. (Medical Sec.)*, II (1922), iii, p. 237; Auden, “Behaviour Changes Supervening upon Encephalitis in Children,” *ibid.*, II (1922), p. 901; Shruballs, “The After-history of Some Cases of Epidemic Encephalitis, with Especial Reference to Changes in Conduct,”

these cases the special interest lies in the unquestionable relation that they seem to establish between an organic lesion of the brain and a lack of moral control.

The physical sequelæ are manifold—squint, tremor, muscular rigidity, and the various symptoms of a residual paralysis. In the most typical examples there are mild intermittent spasms of the hand or arm, persisting sometimes for years, and suggesting a sort of localized epileptiform seizure. In some the initial ailment has never been rightly identified, but simply reported as a "feverish attack," or as "influenza," or as an aspect of measles or scarlet fever—diseases often followed by encephalitis of the epidemic type and occasionally confounded with it. But quite apart from epidemic encephalitis, the commoner forms of so-called meningitis and the many acute infectious illnesses of childhood—diphtheria, scarlet fever, measles, and the rest—are themselves at times attended by cerebral inflammation; and may leave disorders in their wake similar to those I have just described.

How deeply the child's mind may be impaired as a consequence depends upon two crucial facts: first, the severity of the initial disease, and, secondly, the age of the child when the disease attacked him. In children under three years of age gross imbecility is likely to ensue. In children between four and eight, the milder degrees of dullness, backwardness, or mental deficiency are more probable. In children that succumb between the ages of eight and twelve there may be a slight retardation in general intelligence, but the chief residuary disturbance is one of temperament and character. The child is unable to stand the least worry; he becomes emotional, irritable, and restless; and may develop strong criminal propensities—petty violence,

---

*Journ. Neurol. and Psychopathology*, IV (1923), p. 236; Glen, "Cases Illustrating the After-effects of Encephalitis Lethargica," Metropolitan Asylums Board, *Annual Report*, 1923, pp. 202-213 (an instructive series of case-histories for patients received at Darent Training Colony), Ministry of Health: *Reports on Medical Subjects*, No. 11 (1922) and *Memorandum on Encephalitis Lethargica* (1924). A detailed bibliography of over 2,000 numbers will be found in Arthur J. Hall's treatise on *Epidemic Encephalitis* (Simpkin, Marshall, Hamilton, Kent & Co., 1924, pp. 155-229).

perverse mischief, and mean and motiveless theft. Running away is less usual. Sexual misconduct seems rare.

(c) *Chorea*.—Apart from epidemics, delinquents suffering from past encephalitis are relatively few. Choreic or sub-choreic conditions, on the other hand, are common. They were apparent in over 6 per cent of my cases. Chorea—St. Vitus' Dance, as it is popularly termed—is nearly always accompanied by some degree of emotional instability. The jerkiness of the body and limbs seems to find its psychical counterpart in a jerkiness of mind and conduct, and these mental spasms, or rather the underlying lack of control of which they are the fitful signs, end often in criminal transgressions.<sup>21</sup>

Chorea is a disease of rheumatic origin, and rheumatism, whether attributable to a defect of metabolism or to some definite germ infection, is prone to invade and to inflame all mucous membranes—those delicate tissues that line the joints, the eyeballs, and the larger cavities of the body, and form the wrappings of the brain. In many, the infection finds a permanent lodging at the back of the nose and throat; and spreads thence, as from a focus, to different regions of the body at times of low vitality. A distinct catarrhal cycle may often be traced: first, an exposure to wet and cold, then an aching of the limbs or head, succeeded perhaps by an obstinate soreness of the tonsils, developing through neglect into a more or less feverish affection, leaving behind a general feeling of lassitude and fatigue, a restless malaise of mind and body, till at length the little convalescent, bored with precautions and growing more excitable and restive, runs out again into the chill damp air; and during one or other of these stages, most frequently the last, comes a burst of emotion and misconduct.<sup>22</sup> The chronic sufferer from such catarrhal or rheumatoid states frequently shows symptoms that may be termed sub-choreic, though sometimes

<sup>21</sup> It is of interest to remark that recent pathological work suggests that the lesions in chorea affect much the same portion of the brain—the basal ganglia and probably the motor cortex—as the lesions left by encephalitis.

<sup>22</sup> It will be seen from my table (page 240), that recurrent catarrh is the commonest ailment in the entire list; and is more than twice as frequent among the delinquents as among the non-delinquents.

not pronounced enough to have been treated as chorea. At school he is nearly always backward; and it is the recurrence of his mild indisposition—perhaps described only by its most conspicuous symptom, as “frequent headaches,” “frequent sore throats,” “frequent spells of restlessness,” or “growing pains” (usually at night or during damp weather)—that so often suggests the true diagnosis. The suspicion thus aroused may be conclusively confirmed by a history of rheumatic fever, heart trouble, or arthritis, either in the relatives or in the child himself.

The nervous symptoms become more and more pronounced among the older cases, and are commonest in unstable girls verging upon puberty. In some the nervous condition appears primary and the catarrhal or rheumatic complications operate chiefly as aggravating factors. During the last ten years, among the delinquent children that I have examined, the proportion of choreic or quasi-choreic cases has undoubtedly increased; and in London such cases seem to be most frequent in the damp, low-lying areas just south of the river.

### Treatment

Unlike other physical disorders, these nervous ailments are commonly the main cause of the child's delinquency. To treat them rightly, therefore, is as a rule the first and last essential.

1. *Removal to Hospital or Other Institution.*—Where the diagnosis is clear and unmistakable, the proper course can seldom be a point for doubt. The epileptic child can usually be transferred to an institution for epileptics.<sup>23</sup> The choreic, in spite of the apparent mildness of the complaint, is best dealt with away from home. He needs protracted rest—rest, first of all, in bed for several weeks, then rest out of doors in the country with gentle, interesting, unfatiguing occupation. Often this advice has already been tendered to the parent; but with a fidgety child not obviously suffering pain it is difficult to insure that the treatment shall be fully carried out in an ordinary household. The child refuses to lie down for long and is forever

<sup>23</sup> There is also a special industrial school for epileptic children who are of the Roman Catholic faith at Much Hadham, in Hertfordshire.



skipping out into the cold and the wet; the physical exertion and emotional excitement, into which his impetuosity spurs him, may precipitate or aggravate those affections of the heart to which the choreic and the sub-choreic are so liable. As an out-patient at a clinic or dispensary his progress is often disappointing. As an in-patient at a hospital or an open-air institution he will generally submit to the required routine, and his condition can be watched and cared for away from all struggle and fuss.<sup>24</sup>

Post-encephalitic cases are the most difficult of all. Where the maniacal outbursts are dangerous, the patient must be removed to a mental institution.<sup>25</sup> But the majority of cases can be certified neither as insane nor as morally imbecile. What is to be done with them? Everywhere they are refractory and troublesome to manage, since, besides their impulsive stealing and occasional truancy, they are nearly always spiteful, ill-tempered, and destructive. The persons who have been kindest to them are the very ones against whom they turn. As a consequence they may be passed from one convalescent home to another, and frequently finish in the police court. Yet their state is not totally hopeless. With patience, sympathy, and a firm hand, with early removal to a well-ordered institution if

---

<sup>24</sup> On the general treatment of the choreic child, I may refer to the specific recommendations appended by my sister, Dr. Marion Burt, to her note on the after-history of such cases (*Annual Report of the School Medical Officer*, Birmingham, 1923, pp. 22-4). I may add that special precautions are needed in the open-air treatment of such cases. In the ordinary open-air school the choreic child does not usually do so well; but whatever means are adopted, when the child has been successfully shielded from, or hardened against, petty catarrhal trouble, both the nervous and the moral disturbances tend to diminish.

<sup>25</sup> A number of cases have, for example, been received and treated with success at Darent Training Colony (see Glen, *loc. cit. sup.*). Inquiry at a hundred asylums in England and Wales showed that during 1918 as many as thirty cases of *encephalitis* were admitted; and, from a more recent investigation of the Board of Control, it would appear that there are now over 100 cases, of varying age, in the mental hospitals. Since the defect is acquired and not innate, it is difficult to certify such cases as mentally deficient in the technical sense. This can only be done by stretching the legal phrase "existing from an early age" to cover diseases which attacked the patient during the first few years of childhood—an extension dubious in theory but sometimes convenient in the interests of the child and those about him.

these conditions cannot be secured at home, and with continued care and supervision for three or four successive years many have been known to recover. The physical symptoms may vanish in a year or two; the power of sustained attention returns more slowly; irritability and lack of self-control are the last to disappear. I have seen more than one of these perplexing cases, which had defied every effort of parent and teacher, slowly and surely improve after transference to an industrial school. But the special care required by such a child imposes a great strain upon the staff. Accordingly, committal to a certified school is to be looked upon as an exceptional proceeding—a measure which at most is but a poor second best. The worst cases, as experience has amply proved, are wholly unsuited for such a place. There remains, therefore, one urgent and obvious solution—the establishment of a small public institution specially for post-encephalitic patients; and now that the need is widely recognized, it should no longer be hard to supply.

2. Attention to Mild and Early Stages.—It is, however, to the slight and ill-defined cases falling within this general group that I am most anxious to direct attention. Where the history of epilepsy, chorea, or encephalitis is beyond dispute and where the resulting condition is grave, the appropriate authorities are always ready to do what they can; they have a clear ground for action. But where the physical affection has been so trifling as to be overlooked or remains little more than a matter of unverified surmise, there may be much hesitation in recommending radical measures. Yet it is in the mild cases and during the mild stages that delinquency is most likely to develop. The acute illness may have been successfully nursed at home, and at home an attempt is still made to deal with the patient during his tedious convalescence. There, more particularly if the family is poor, ignorant, and overcrowded, the peevishness and willfulness of the wayward invalid are bound to be aggravated rather than diminished; his faults and caprices are at first humored with indulgence and then punished with impatience. At last his exasperating outbreaks recur with such frequency that he is sent away. But by this time his reckless behavior has become so fixed and so habitual that long after the original

disturbances of health have been completely cured, it is likely to survive as a permanent trait.

With all these cases, therefore, and with the post-encephalitic most of all, early removal seems imperative.

3. *General Hygienic Measures.*—Where the restlessness has already reached an intolerable pitch, a course of some sedative is occasionally helpful. The child is tranquilized, and if the period of tranquillity can be sufficiently prolonged, the delinquent habits themselves may drop away. Bromides are often excellent for these excitable young people, but sometimes they would act better if administered to the parent. As a rule, sound and steady measures of general hygiene and judicious management from the first are far more efficacious than any drug, and should be continued long after the first compelling need for them has arisen. So long as physical health keeps normal, mental health is less likely to suffer a relapse. Indeed, it is my view that in most of these tiresome little patients the ensuing emotional and temperamental trouble is but remotely related to the underlying physical lesion, whatever it may be; it seems to form, in its essential nature, a secondary psycho-neurosis that supervenes during their slow recovery.<sup>26</sup>

#### *Conditions of Doubtful Significance*

Two other conditions may appropriately be dealt with under this general heading. Both are repeatedly mentioned as giving rise to faults of character. Neither, so far as my own data go, have more than a slight and doubtful significance.

(d) *Head Injury.*—A blow upon the skull is often cited as a charitable explanation for subsequent misconduct. During early infancy the child perhaps has had a fall. Later, like most children, he has suffered from passing headaches, and the complaint is enlarged upon by the patient or his friends, in the hope, perhaps, that "something wrong in the head" may be received as an extenuating plea. Not parents only, but teachers and even doctors, are sometimes quite content to interpret a career of crime as the direct outcome of a battered cranium; and in

---

<sup>26</sup> With the nature and treatment of psycho-neurotic conditions I deal in Chapter XIII.

more than one instance I have observed that the interpreter is satisfied by the mere presence of a scar upon the scalp, seeking no evidence for damage to the brain itself beyond an occasional throb.<sup>27</sup>

That a severe head injury is frequently followed by a change of disposition is not, of course, to be denied. Sometimes, even when the knock itself has produced neither a fractured skull nor any outward symptom of concussion, a post-mortem examination many years after will disclose a permanent injury to the nervous substance or adjacent tissue, caused apparently by an internal bruising and its consequences. Such an injury might naturally entail either physical or mental disturbance or both. Physical symptoms may appear among the more immediate results, and of these the most definite are epileptiform seizures. The patient may have attacks of dizziness and be easily upset by heat, by noise, and by such stimulants as tea, alcohol, or nicotine. The mental effects are also at times suggestive of the traits of the epileptic. Of the psychic changes the commoner are increased irritability, increased impulsiveness, increased susceptibility to excitement and fatigue, a slight deterioration of memory and judgment, and a marked impairment of self-control. In school the child appears fidgety, inattentive, and forgetful; out of school he may become passionate, self-willed, and full of mischief.

As a rule, there is nearly always a neuropathic constitution

---

<sup>27</sup> In one such case, that I have upon my notes, what the psychiatrist calls suggestion had evidently brought about an apparent confirmation of the theory. A boy of nine was sent to me, charged with repeated truancy and theft. Directly his bald patch was commented upon, he volunteered: "I was run over when I was five and I've never been the same since." When his mother came with him at a later interview, it became clear that she had got into a mechanical habit of holding the boy's scalp for inspection to any neighbor, teacher, or doctor who showed sufficient interest and of accompanying her demonstration with the same clockwork comment: "He was run over when he was five and he's never been the same since." The boy was hysterically inclined and suggestible to a high degree. Subsequent analysis proved plainly that the constant apology for his supposed condition had, in part at any rate, given him a character to live up to. The element of suggestion, it is true, was not the sole factor; but it pointed to a simple line of treatment. Light hypnosis was sufficient to produce a quick and lasting cure.

in the background, and the accident does what it seems to do rather as a precipitating than as a primary cause.

Such a child should be taken to a hospital. X-ray and other methods of examination may show whether there is pressure by bone or fluid. Brain surgery as a cure for crime is a favorite proposal of parents and teachers and in these cases is sure to be inquired after. But though an operation may successfully relieve the fits that follow certain fractures, there are few cases on record where character has been improved by the intervention of the surgeon.

General measures are the most effective. The child must be shielded from overwork and overstrain; too much repression and too great stimulation are equally bad. A quiet life in the country is better by far than the bustle and hubbub of the town.<sup>28</sup>

(e) *Syphilis*.—Of recent years, particularly on the Continent, much notice has been paid to congenital syphilis as a factor in juvenile crime. Where there is a history of syphilis in the father or mother and of lawless conduct in the child, observers have been apt to infer direct causation. Often, however, the history of disease becomes illuminating, chiefly by the light it throws upon the temperament and habits of the parent. Until lately, for manifest reasons, precise statistics have been hard to procure. The outward stigmata of congenital syphilis are known to every one—a wizened and wasted appearance, a face prematurely aged, an asymmetrical or misshapen skull, marked frontal eminences on a prominent forehead, an undeveloped nose with depressed bridge and *retroussé* tip, notched and peg-shaped upper incisors, the rest of the teeth being often widely spaced, scars radiating at the angles of the lips, and perhaps a scarred or ulcerated cornea seriously impeding the child's sight. Persons with these patent signs are relatively few. The introduction of the Wassermann blood test, however, has now made it pos-

---

<sup>28</sup> Bernard Glueck has emphasized the importance of "Head Injury as a Cause of Crime" in an article with the title, *Bulletin of the American Academy of Medicine*, XV (1914), iii, p. 156. For the student of delinquency the best general reference is Adolf Meyer's study of "The Anatomical Facts and Clinical Varieties of Traumatic Insanity," *American Journal of Insanity*, LX (1904), iii, p. 373.



sible to obtain direct information about the child's condition; and where this test has been applied, it is claimed that a vast number, with no obvious symptoms and no known history of the disease, prove to have been infected with the taint.<sup>29</sup> At the new Bureau of Juvenile Research in Ohio, Dr. Goddard, who has taken up this subject with the same enterprise and enthusiasm that he gave to the study of mental deficiency, has found that in a series of over two hundred cases referred to him from the Juvenile Court, as many as 8 per cent were syphilitic. He believes that "a surprisingly large proportion of delinquency is due to this disease."<sup>30</sup> It is a familiar fact that children who apparently recover from the original affection (which, of course, declares itself soon after birth) may at the period of second dentition or of puberty show renewed manifestations. The mental after-effects vary enormously. They range from gross mental deficiency, supervening at an early age, or the juvenile form of general paralysis, supervening about the time of adolescence, down to mere nervous instability and headache. The disturbances in conduct resemble those already enumerated in discussing other forms of cerebral impairment.

Where such conditions are suspected, quite apart from any obvious or external signs of earlier illness, a blood test should be made. Many have urged that the test should be turned into a routine procedure for all cases,<sup>31</sup> and this course, if adopted

---

<sup>29</sup> See Bernard Glueck, "Head Injury and Syphilis as a Cause of Crime," *loc. cit. sup.*, XV (1914), iii, p. 160. Plaut ("Zur Forensischen Beurtheilung der Kongenital Luëtischen," *Zeitschrift f. d. ges. Neur. u. Psych. Orig.*, Bd. II, 1912) relates that since the application of the Wassermann reaction as a regular measure at the Psychiatric Clinic in Munich it has been discovered that so-called hereditary syphilis is far more common than has hitherto been supposed. Among the children of syphilitics "at least one-third inherit the disease"; mental manifestations, he finds, are far commoner than physical, and emotional disturbances than intellectual. It should be added that, while a positive Wassermann reaction is nearly always significant, a negative reaction is now taken to be less trustworthy.

<sup>30</sup> *Juvenile Delinquency* (1923), p. 106. Healy's figure is 2.6 per cent (*op. cit.*, p. 137); the diagnosis, however, was made chiefly from bodily signs not from laboratory tests.

<sup>31</sup> Healy, for example, "hopes to see these harmless tests for inherited syphilis done on all children who come under public care" (*loc. cit.*,

for at least one large sample of the delinquent population, would certainly produce more accurate statistics even if it led to no startling cures. When there is evidence or a history of congenital disease, whether the earlier manifestations have disappeared or not, the patient should be kept under supervision and if necessary placed again on specific medical treatment.

Acquired syphilis in children is naturally rare. Among older persons, general paralysis of the insane, recognized everywhere as a form of insanity that may commence with criminal behavior, is now attributed to this infection. But among delinquent adolescents and adults, and particularly among young women, syphilis is a result of misconduct more often than its cause. It is unnecessary to urge the importance of isolating infected cases and of making the diagnosis and starting the treatment at the earliest moment possible.

### III. PHYSICAL IRRITATIONS

#### 1. General

Physical discomfort of every kind is apt to sharpen general nervous irritability and in particular to increase impulsiveness. The discomfort itself may come from sources altogether trifling. A sore, a smarting wound, a swollen gland, an eruption of the skin, or a disorder of the stomach may be enough to unhinge a child's weak will. Carious teeth cause toothache; bad sight uncorrected by spectacles brings eye strain; eye strain, general fatigue, and countless forms of mild ill health produce in turn continuous or recurring headache. In one who suffers from such physical annoyances, all calm intellectual occupation, all cool and quiet reflection upon conduct and its probable results are for the time being in abeyance. As a result, instinctive and impulsive action preponderates, and the unpleasantness of the inner stimuli sets up a temper of fretful petulance that tends to wreak itself on the world without. Often, too, the jaded mind snatches eagerly at any sedative or stimulant which may

---

p. 205). I may add that, generally speaking, in the medical work done in connection with juvenile courts in America, far more stress appears to be laid upon the investigation of the incidence of venereal disease than is the custom in Great Britain.

seem likely to dispel, or at least help it to forget, the importunate twinges of pain. The young child takes to sweets and dainties (often stolen for this very purpose), or to the picture theater, or to restless spells of aimless wandering; the older youth turns to spirits, tobacco, or gambling; and the older girl to flirting, to fast and frivolous diversions, or to the more desperate solace of cocaine.

## 2. Specific Irritations

One special form of discomfort, petty enough in itself, must be explicitly mentioned. Physical irritation of the sex organs is a condition not uncommon in delinquents when examined with care; it stands often in a causal connection, direct or indirect, with their habits of misdoing. No physical trouble is so liable to be overlooked. The child does not like to allude to it, and those who have to deal with him, even when medically qualified, do not like to search for it—particularly when examinations have to be made in a public office or the schoolroom. Discomforts of this kind act in part like all other discomforts of the body, creating a vague mood of uneasy disquietude forever in the background of the mind. But in part they have mental consequences more specific and more serious. There may be a stifled sense of anxiety or shame.<sup>32</sup> There may be a ceaseless inner debate whether to mention the matter or not. The slight local inflammation itself may heighten sexual excitement and lead either to sex delinquencies and to the practice of self-abuse, or, if these are repressed, to some form of substituted delinquency.<sup>33</sup>

---

<sup>32</sup> Often based on early threats of some local disaster as nature's punishment for bad sex habits (see Chapter XII under "Complexes," p. 524, and cf. Table XXI).

<sup>33</sup> Phimosis is most commonly referred to in this connection, and circumcision is usually advised as a cure for both the physical and the moral trouble. Among my own cases, *herpes preputialis* in boys and *pruritus vulvæ* in girls seem far more frequent. Discomforts arising from intestinal parasites and from insufficient control of the sphincters of the bladder and rectum, also at times have a similar effect. With the latter the condition is itself often a sign of mental or moral degeneracy—part of the general lack of self-control or of the general loss of self-respect so characteristic of many delinquents; at times it constitutes

## Treatment

Whether specific or general, these paltry irritations form the precipitating rather than the ulterior causes of delinquency. A toothache or a headache will not of itself drive a normal child to stealing or assault. There is again, nearly always, some deeper instability of temperament which renders him peculiarly intolerant of the least distress. To remove the discomfort is usually the first and easiest step; the underlying instability may then dissolve of itself or be made the subject of intensive treatment later on.

In many cases of localized trouble it must be remembered that the actual irritation may not consciously be perceived as such. And, with or without any conscious pain, a concurrent effect of yet greater import may be the general weakening of the physical system by poisons absorbed from septic foci. The extraction of a tooth, the drainage of an infected sinus, the cure of an intestinal sluggishness, may not only ease the child of long-continued suffering, but also destroy a chronic source of auto-intoxication which in turn may have sapped his power to bear the insistent pain.

## IV. SPECIAL DEFECTS

### 1. Vision

Eye trouble seems to affect the child in two or three different ways, each liable to promote delinquent habits. Marked defects of sight were found in 7 per cent of my cases; and slighter defects in nearly 10 per cent.<sup>34</sup> Whether marked or slight, they

---

a mild neurotic reaction, and what may be termed a psycho-analytic mechanism often lies at the root or develops on the basis of such a habit (see Chapter XII, p. 527). Carelessness in controlling the functions of the rectum is far rarer than enuresis. But it is, in my experience, a much commoner source of increased complaint against the child; from time to time a wave of dirtiness seems to sweep through industrial schools and reformatories, and the feature becomes almost epidemic.

<sup>34</sup>Here again reference to a control group is necessary before the absolute figures can be taken at their face value. So far as my own statistics go, it will be seen that whether mild or marked, defects of vision are if anything less frequent among delinquents than among non-delinquents from the same social class. Yet, in one case, a marked defect of vision was certainly the principal cause of delinquency. And

were commoner, as, indeed, is generally remarked, among the female sex.

Defective vision hinders reading and the bad reader, gravely handicapped as he is alike in school and in after life, often slips, when circumstances or his own temperament are against him, into dishonest ways.<sup>35</sup> Reading, whenever he attempts it, becomes associated with pain and worry, with feelings, obscurely located, of strained eyes, sore lids, recurring headache, and general discomfort and fatigue. From the best and commonest way of filling a vacant hour indoors, he is debarred. The world of books and even the bookish people who live in such a world grow into objects of a vague dislike. The child becomes one of the illiterate. For him, the chief channel from which men draw their higher and refining thoughts is closed. More and more he sinks down into the concrete day-to-day life of the senses.

Many visual defects bring disfigurements in their train. The wearing of spectacles, the affliction of a squint, the red and watering eyelids, all the strange mannerisms that the dim-sighted so often contract, call forth banter and ridicule from the child's companions and prove sources of shame to the little martyr himself. The near-sighted or myopic, perhaps because the things outside them look so blurred and indistinct, are peculiarly apt to be flung back upon their inner life; they brood and daydream. The hypermetropic and the astigmatic suffer in another way. Their defect is less serious out of doors, but they are incapacitated for all close work—for reading, writing, and fine needlework. They experience more strain and annoyance; they become more peevish, more querulous, and more prone to nervous headache; and often they have longer to wait before the true nature of their infirmity is observed.

As the weak-sighted child grows up and passes from school to business, his wretchedness may be renewed. The taunts and nicknames crop up afresh; for in the humbler walks of life

---

this, incidentally, shows how the method of intensive individual studies may bring causal connections to light that might never be revealed by statistical comparisons, however wholesale and extensive.

<sup>35</sup> See page 329.



there is on all sides a prejudice against the purblind and bespectacled. Towards adolescence, a girl more particularly is sensitive about being placed behind a pair of lenses and having (as one of them expressed it) her face "glazed in and wired"; and this of itself may be enough to precipitate a stubborn revolt.<sup>36</sup>

It is, therefore, always important that upon the least suspicion of defective sight the child's eyes should be thoroughly tested. The common letter-test is often insufficient; hypermetropia and astigmatism may easily be missed at a simple school inspection. Due measures should be taken to relieve even the slighter forms of defect, and if necessary a school or an employment should be found where the trouble is neither a source of painful inefficiency nor an occasion for derision and contempt. Troubles of this kind, however, seldom constitute the sole or predominating factor; and adjuvant causes should always be sought.<sup>37</sup>

---

<sup>36</sup> The case of Olive I., narrated above (page 244), to some extent exemplifies this point. Readers of Henry James will also be reminded of his tale entitled "Glasses" and of his subtle psychological study of the heroine—the lonely daughter of dead and dubious parents, and herself a fair, but false and foolish creature, who suffered from some congenital affliction that menaced her beautiful eyes; and who, growing as dishonest as she was vain and handsome, preferred to endanger and eventually to lose her sight, rather than sacrifice a life of power and pleasure, and the chances of an opulent match (*Embarrassments*, pp. 67-150).

<sup>37</sup> Where the special nature of the visual defects—inflammation of the iris, ulceration or scarring of the cornea—together with other signs and incidental information, suggests a history of syphilis, presumably congenital rather than acquired, the examiner will, besides other obvious recommendations, consider also the light thus indirectly cast upon the probable temperament inherited from the parents, and the probable nature of the home environment. I have known, in one case, additional conflicts caused by the victim's awareness of the real origin of his hampered vision; some one had remarked in the hearing of the unfortunate boy that "the father had eaten sour grapes, and the children's teeth were in consequence set on edge." The result was a long series of revolts against the authority of his parents—stealing, temper, running away—which only ceased when the lad began to earn his own living and to be independent of his home.

I have noted above that a special industrial school has been established at Chigwell, in Essex, for Roman Catholic boys who suffer from ophthalmic troubles.

## 2. Hearing

Partial deafness is a yet more serious impediment to progress, both at lessons and later on at work. It forms, therefore, a still more frequent cause of backwardness and incompetence; and the sufferers are still more likely to acquire some personal eccentricity as a result. Defective hearing is rarer than defective vision. Marked defects were found in less than 2 per cent of my cases; slight defects in nearly 4 per cent. Cut off, as they are, from free social intercourse, the partly deaf are deprived in early years of any keen awareness of the public opinion around them; they are thus removed from one of the strongest deterrents against low and underhanded action. Later on, as he grows up, such a child may become acutely apprehensive about what people may be thinking of his own character or conduct; and so gradually take up a morbid standpoint, inwardly suspicious, outwardly defiant, towards society as a whole.

This deprivation, this moral exile, as it were, seems to bear with a special burden upon girls; girls are always more dependent on the attitude of the persons about them. Boys compensate for their defect with greater readiness; for the natural bias of the boy is to be less occupied with persons than with things. But, whether boy or girl, the deaf child soon becomes the forlorn and solitary child—a little human derelict. He is left to drift away by himself; or to float into the company of dull and doubtful acquaintances, ne'er-do-wells who make small demands upon his blunted apprehension. As a rule those who are difficult of hearing, unlike those who are defective in vision, develop a character meek and weak-willed rather than irritable or aggressive; and the deaf delinquents that I have encountered have been given less to outbreaks of violence or adventure, and more to offenses that are petty and mean.<sup>38</sup>

---

<sup>38</sup> This does not hold of the extremely deaf—for example, the congenital deaf-mute. Inheriting, as they so often do, an unstable nervous temperament as part of their general defect, the deaf and dumb may at times prove exceedingly recalcitrant. Fortunately, in this country, the majority of those who are completely deaf can be accommodated in residential institutions—although, even there, the difficulties are by no means at an end.

A deaf child is often tempted to make capital out of his known weakness. He can plausibly claim not to have heard injunctions or reproofs; and may win, by his willful obtuseness, a reputation for more stupidity than is really his. Should his deafness be intermittent, he soon finds the double convenience of hearing when he is not meant to and of seeming to be deaf when he does not wish to obey. And at last the parent or teacher who is not quick enough to turn a defense so baffling gives up in despair all effort at correction.<sup>39</sup>

Besides the ordinary and obvious methods of dealing with deafness (with special regard, as always, to the small incidental afflictions whether of body or of mind), it is highly important that the deaf delinquent should be given occupations where his trouble handicaps him least. This is essential, not only in school, but also out of school and after school life is over. Situations that involve little contact with his fellow beings, except for one or two who understand his state, are always to be preferred. I have had excellent results from two young thieves, both partly deaf, who were transferred to a country village; here, first as children and later as youths, these former intractable rebels found their energies altogether engrossed by work on the land and their deafness passed all but unnoticed.

### 3. Speech Defects

Impediments in speech are met with from time to time among delinquents, particularly among delinquent boys.<sup>40</sup> Their sig-

---

<sup>39</sup> Here my experience does not quite tally with that of Healy. Healy observes that "markedly defective hearing is not nearly so frequently found among delinquents as defective vision; even then we cannot regard it as of any importance except when it has interfered with education, wholesome interests, or occupational success" (*op. cit.*, p. 218). Defective hearing is also far less common among the population generally; so that, if among delinquents its absolute frequency is small yet its relative importance may be great. Among my list of analyzed cases, I find at least three (all girls) where partial deafness seems certainly to have obstructed the development of a sound moral character, and that in ways far more direct than those remarked by Healy.

<sup>40</sup> In my series of 200 delinquents I found two cases of speech defect among the boys. In one the defect was the ultimate and main cause of the child's bursts of violence, and with the cure of the defect the

nificance is twofold. / First, they may in themselves be indicative of an inborn nervous and emotional instability and sometimes of a nature deeply degenerate. Secondly, any sense of shame and inferiority is greatly augmented by such a misfortune as a stutter. The stuttrer feels himself an outcast from normal society. The teasing to which the spectacled and the deaf are subjected is nothing to the persecution with which the stuttrer is continually plagued; the perpetual jeering and jibing and the unending dread of it may lead, by a path not difficult to comprehend, to violent outbreaks and to lasting antisocial resentments. Direct reactions—such as retaliatory assaults and even suicidal threats and endeavors—are by no means uncommon; indirect reactions are almost inevitable.<sup>41</sup>

Here, again, apart from regular methods of treatment, it is necessary that the sufferer should mix as little as possible with unsympathetic companions. He should be protected from the society both of complete strangers and of those rougher and more callous acquaintances—so common among the neighbors of the stammering boy from a rough working class—who are likely to taunt, enrage, and exasperate him.

### Physical Peculiarities as Criminal Assets

Not every physical peculiarity that contributes to delinquency is intrinsically a defect, nor is every defect felt by the offender as a drawback. Certain features of physique may prove a definite asset to him; and the deliberate perception or the accidental discovery of their social value—whether by the possessor himself, or by his parents or confederates—may become an appreciable factor in his criminal career.

The child who is so slim that he can squeeze between railings or slip through a half-open window, or who, from his diminutive size, can dodge observation, or, from his seeming babyhood, escape all serious suspicion, such a child, if he is at all quick-

---

trouble ceased. There were, in this series, no cases of speech defect among the girls.

<sup>41</sup> To this subject a special paper has been devoted by Th. Hoepner: "Über die Disposition der Stotterer-Psyche zu Asozialer Entwicklung," *Gross Archiv für Kriminalistik*, XLIX (1912), pp. 149-734.

witted, makes a useful accession to a piratical gang. Tiny fingers are a convenience to the pickpocket; small hands are a help to the little scamp who feels under doors or down letter-boxes for envelopes containing a treasury note or a check. Strength and size, as we have seen, may be subservient in a different way; the big and burly fellow soon learns that he can gain his ends better by bullying and intimidation than by trying to sneak by unperceived. Nor is it only some quality of normal growth that may here and there be helpful. Even defect and disease may be turned to an account: the more harrowing they are, the better. A pale and haggard countenance, a loathsome-looking skin complaint, a conspicuous deformity like a crippled leg or a crooked spine, may become a real advantage and a rare advertisement: such disfiguring afflictions may be exploited with profit, either by the sufferer himself or by his unscrupulous relatives, for catching the attention and winning the sympathy of the casual passerby. One lively rogue of my acquaintance, whose face had been hideously scarred by scalding water, became a professional beggar at the age of nine. He found it paid to hire a bigger comrade, who, when a stranger approached, would draw compassionate notice to his unsightly accomplice, either by some startled exclamation ("Ooh—look at that pore kid's fyce"), or by some feint of bullying. Healy quotes the case of a boy of fourteen who had inflamed lachrymal ducts and so could bring copious tears to his eyes at will—a practice that proved a gold mine to his family and himself.

A pathetic, innocent, or frank expression will often conduce to the same remunerative end. Some of the most hardened little thieves I have encountered were, like Johnny E., possessors of a sweet, seraphic countenance; and too often the inexperienced teacher or official would decline to believe the evidence against a look so childish and so saintly.<sup>42</sup>

But the most obvious instance of a physical advantage is the possession of a comely face or figure by a growing girl. As

---

<sup>42</sup> Sometimes, I fancy, the opposite error is made. A boy endowed by nature with a shifty appearance is treated as a shifty character, until he comes to think he must be a shifty character, in fact, and begins to behave as everybody is assuming.



we have already seen, good-looking children, when young, are speedily spoilt; they soon find out that they can win more by trusting to their prettiness than by depending on their industry or brains. At an older stage, the allurements of an idle life of immorality may lead the handsome adolescent girl either directly into misconduct or into substitutional delinquencies resulting from the effort to withstand the seduction. "As clever as she is bad, and as bad as she is beautiful," ran the comment of an official on one of my most hopeless cases. For such a girl life in a town like London has always been full of risks; her history found its classic description over two centuries ago in the autobiography of Moll Flanders.<sup>43</sup> And since those days many a parent has echoed the cry of Polly Peachum's mother: "How is the Woman to be pitied who hath handsome Daughters! Locks, Bolts, Bars, and Lectures on Morality are nothing to them: they break through them all!"<sup>44</sup>

In a boy an effeminate and attractive appearance may have much the same outcome—particularly should he happen to live near the West End of London, where base practices are readily picked up, or be sent to some school or residential institution where the tone and tradition are corrupt. And in either sex, quite apart from these rarer and more flagrant consequences, good looks are fatally apt to foster a type of character which in psycho-analytic treatises is known as narcissistic; then, as we shall find in a later chapter,<sup>45</sup> this so-called narcissism affords in turn a fertile soil in which delinquency takes root. "Beauty in woman," says a cynic in one of Landor's dialogues, "is often a sign of a cold and selfish heart; and in men it is so almost always."<sup>46</sup> There is more than a grain of truth in the paradox.

---

<sup>43</sup> "Since I was quick and pretty, and had often been told so, it was my pride more than my principle that had kept me honest so long. But, so soon as vice instead of honesty was made to flatter my conceit, I gave myself up to being ruined without the smallest concern; and am a fair memento to all young women whose vanity prevails over their virtue" (Daniel Defoe, *The Fortunes and Misfortunes of the Famous Moll Flanders, written from her own Memorandums* (1721), p. 19).

<sup>44</sup> John Gay, *The Beggar's Opera* (1728), I, viii, 44.

<sup>45</sup> See Chapter XII.

<sup>46</sup> Landor, "Vittoria Colonna and Michael Angelo," *Works*, V (1876), p. 287.

Regarding treatment, two deductions are obvious, yet frequently overlooked. First, those who deal with such cases must be watchful lest their own tender feelings mislead them; secondly, they should endeavor to place the child where the quality that has assisted him in crime may assist him equally to an honest life, and so seek to substitute a healthy personal pride for a sham self-pity or a hollow self-conceit.

## CHAPTER VII

### INTELLECTUAL CONDITIONS: SUBNORMAL INTELLIGENCE

Τὸν δ' οὔτ' ἄρ σκαπτῆρα θεοὶ θέσαν, οὔτ' ἀροτῆρα,  
οὔτ' ἄλλως τι σοφόν.

Him have the gods given wisdom, neither as a digger nor  
as a ploughman, neither in aught whatsoever.

HOMER.<sup>1</sup>

*Mental Testing.*—A crime is a conscious act. Hence, its immediate cause, if not always its ulterior origin, must lie in some inner mental state. So far we have viewed the offender from the outside only; we have considered his size, his strength, his physical development, the soundness of his senses and the condition of his health; but nothing more. Too often, indeed, this is all that the medical examination includes. To the psychologist, it is but the bare preliminary. For him, the essential feature of the inquiry is and must remain a comprehensive survey of the child's mentality—of his intelligence, general knowledge, and special capacities, upon the one hand, of his feelings, habits, and interests, his traits of character and stability of mood, upon the other. Accordingly, we now reach the central topic of this work—the direct investigation of the young delinquent's mind.

The general program of the examination may best be understood from the schematic schedule on the following page (Schedule III). We may commence by the easier angle of approach; and turn, first of all, to the intellectual qualities of the child, passing later to the temperamental. What may have been the motives for an act of crime, or what should prove the most effective treatment, it is not possible to surmise, until the intellectual endowment of the offender has been accurately determined. A lack of intelligence may be the main reason for

<sup>1</sup> *Margites, cit. ap. Aristotle, Nic. Ethics, VI, vii, 2.* Aristotle cites Margites—the Greek Tyll Eulenspiegel—as an instance of defect in “general wisdom” as distinct from specific or “partial wisdom.”

## SCHEDULE III

## PSYCHOGRAPHIC SCHEME

## I. HISTORY:

A. FAMILY HISTORY

B. PERSONAL HISTORY

## II. PRESENT SITUATION:

A. ENVIRONMENT

B. PERSONALITY

## 1. PHYSICAL CHARACTERISTICS

## 2. MENTAL CHARACTERISTICS:

## (a) Intellectual:

(1) *Inborn capacities:*

(a) General ability (intelligence).

(b) Special abilities (attention, memory, imagination, verbal facility, manual dexterity, etc.).

(2) *Acquired attainments:*

(a) General cultural level.

(b) Special educational and vocational attainments (reading, spelling, composition, arithmetic, drawing, handwriting, etc.; trade experience and skill).

## (b) Temperamental:

(1) *Inborn tendencies:*

(a) General emotionality.

(b) Special instincts and emotions (sex, anger, acquisitiveness, wandering, assertiveness, submissiveness, fear, affection, etc.).

(2) *Acquired tendencies:*

(a) General sentiments (including habits and interests).

(b) Special complexes (including moral conflicts and neurotic states).

his faults, or the possession of intelligence the sole hope of his reform; the presence of some special gift or weakness, the want of common knowledge or school learning, may suggest the right direction for his training. To measure all these different qualities, scientific tests are now to hand; and whatever additional evidence may be taken into account, such tests should always be applied.<sup>2</sup>

In judging the delinquent's intellectual condition, the questions to be resolved are primarily these. Is he above or below the average level for his age? If below, is his backwardness of

<sup>2</sup>A collection of scales for measuring both intelligence and school attainments, devised or adapted for English children, will be found in

a general or of a limited type? And is it inborn or acquired? If his backwardness is both general and inborn, then does its amount seem relatively slight or is it so extreme that he can be certified forthwith as mentally defective?

*The Intelligence of the Delinquent.*—Inborn, general, intellectual ability may be shortly designated by a single word—intelligence.<sup>3</sup> Intelligence is thus defined by a threefold distinction: it is to be distinguished from attainments—which are acquired and not inborn; from special abilities—which are limited and not general; and from temperament or character—which are, in their essence, emotional rather than intellectual. With younger offenders, intelligence is best measured by the Binet-Simon tests. These enable us to express the child's mental level in terms of a mental age; and so to define the exact degree of his ability in units which any one can understand.<sup>4</sup>

What degrees of intelligence are met with among London delinquents will be clear from Table XV and Figure 14. The

---

my *Handbook of Tests for Use in Schools* (P. S. King & Son, 1923). On the general use of psychological tests for the measurement of school children, see the Report on the Consultative Committee of the Board of Education on *Psychological Tests of Educable Capacity* (H. M. Stationery Office, 1924), where the aims, the history, and the chief kinds of tests in present use are set forth in simple terms. For a list of the tests most serviceable in examining delinquents see Appendix II.

<sup>3</sup> For the evidence establishing the existence of this so-called "central factor" see the Board of Education *Report* just cited, especially pages 13 to 16, and the references there given.

<sup>4</sup> For rapid surveys and for older and abler offenders written "group tests" of intelligence may be employed. Through the mediation of one or two friends and colleagues who have acted as educational advisers to governors of local prisons, I have been able to apply intelligence tests of this type to a large number of prisoners; and the results have been used for grading the examinees for such purposes as educational lectures. The group tests employed are those devised by me for the National Institute of Industrial Psychology and already standardized by application to many thousands of children and adults. This standardization renders it possible to compare the level of adult convicts with that of the ordinary adult population. Some of Dr. Ballard's tests, taken from his interesting book on *Group Tests*, have also been tried by the medical officers at the Birmingham Prison and by others elsewhere. As a rule, however, the low mental level and the moral unreliability of the convict render group testing less trustworthy; and where, owing to his attitude of ignorance, any kind of verbal test is likely to give a misleading



TABLE XV.—DISTRIBUTION OF JUVENILE DELINQUENTS ACCORDING TO INTELLIGENCE AND EDUCATIONAL ATTAINMENTS

Mental Ratio	Theoretical Grouping	Percentage of Delinquents Showing the Ratio Specified	
		For Intelligence	For Educational Attainments
135-140	Scholarship or Secondary School Ability	0.5	
130-135		0.5	0.5
125-130	Central School Ability	0.0	0.0
120-125		1.0	0.6
115-120		0.5	0.5
110-115		1.5	1.0
105-110		4.1	2.5
100-105	Medium (Ordinary Elementary School Ability)	9.6	4.6
95-100		15.8	8.1
90-95		14.2	10.2
85-90		16.8	12.2
80-85		12.2	12.7
75-80	Dull or Backward	8.6	11.7
70-75		7.1	14.2
65-70		4.6	10.2
60-65		2.0	5.1
55-60	Intellectually or Educationally Defective	0.5	3.0
50-55		0.5	1.5
45-50			1.0
40-45			0.5
		100.0	100.0

percentages are based on the selected group of 197 boys and girls. To eliminate the effect of differing age, intelligence is

result, tests of a pictorial or practical kind—so-called performance tests—are to be preferred. Alone, in a private office or laboratory, with such tactful approaches as experience and sympathy may suggest, the difficulty of getting even the roughest youth to coöperate in the work of psychological testing is surprisingly small. On the premises of the police court, or in the presence of a police officer or parent, active interest and good faith may be harder to evoke. Should the offender have been told that "the doctor is going to examine his brains, and shut him up in a place for lunatics," then half the interview may go in disarming his suspicions. There are still many who imagine that a mental test involves a minor surgical operation, and that the psychologist, like the professor in the *Water Babies*, goes poking into children's skulls with a probe in his search for their "hippopotamus major." Fortunately, in London, at any rate, the official, if not the general public, is now coming to understand what the purposes of the psychologist really are; and apprehensions of this sort grow more and more rare.

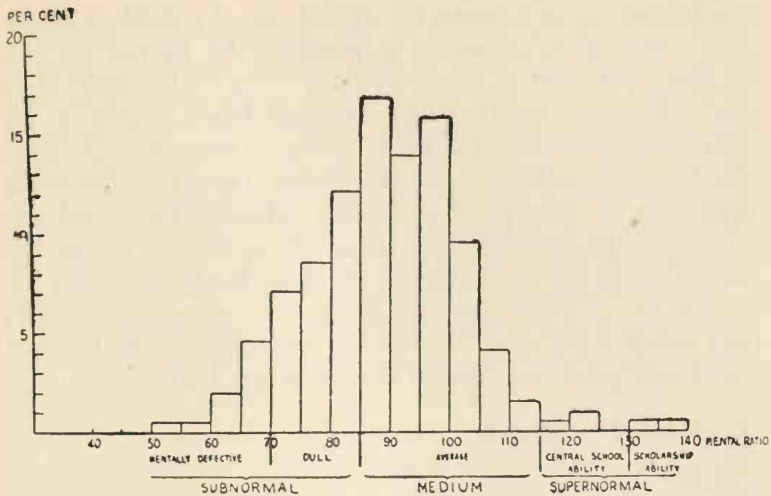

FIG. 14. DISTRIBUTION OF JUVENILE DELINQUENTS ACCORDING TO INTELLIGENCE

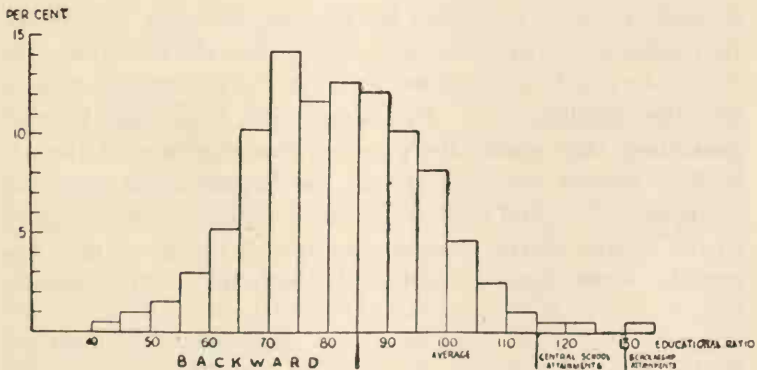

FIG. 15. DISTRIBUTION OF JUVENILE DELINQUENTS ACCORDING TO EDUCATIONAL ATTAINMENTS

measured in terms of the so-called "mental ratio"—the ratio, that is, of each child's mental age to his chronological age by the calendar. Throughout the child's school life this ratio is approximately constant.

The average mental ratio of the juvenile offender proves to be about 89 per cent. This means that at the actual age of

ten he has, on an average, the mental age of a child of barely nine: when he is grown up to manhood, his mental age will be that of a child of about thirteen.<sup>5</sup> But of the table itself the outstanding feature is the immense range of general intelligence over which the whole group is scattered. Between the brightest individual and the dullest, there is a difference equivalent to nine years of growth, although the actual age of either chances to be the same. Nevertheless, by far the majority—82 per cent in fact of the entire batch—are below the middle line of average ability; 28 per cent are technically dull; and nearly 8 per cent are definitely defective. With this last and lowest grade our detailed discussion may begin.

### 1. Mental Deficiency

#### *Frequency*

Of all the psychological causes of crime, the commonest and the gravest is usually alleged to be a defective mind. The most eminent authorities, employing the most elaborate methods of scientific analysis, have been led to enunciate some such belief. In England, for example, Dr. Goring has affirmed that “the one vital mental constitutional factor in the etiology of crime is defective intelligence.”<sup>6</sup> In Chicago, Dr. Healy has likewise maintained that among the personal characteristics of the offender “mental deficiency forms the largest single cause of delinquency.”<sup>7</sup> And most American investigators would agree. In the United States, however, the use of the Binet tests has brought forth figures exorbitantly high and extraordinarily

<sup>5</sup> Inborn intelligence ceases to develop appreciably after about the age of fifteen. Accordingly, in calculating the mental ratio of older adolescents and adults, fifteen is taken as the denominator, regardless of the individual's true chronological age (89 per cent of 15 years = 13.3 years).

<sup>6</sup> *The English Convict*, p. 184. His estimates are somewhat more moderate than those cited in the text from other writers. He argues that “the proportion of mentally defective criminals cannot be less than 10 per cent, and is probably not greater than 20 per cent” (*ibid.*, p. 179).

<sup>7</sup> *Op. cit.*, p. 447. His proportion I calculate to be only 11.2 per cent (*op. cit.*, table on pp. 131-2, including figures for both “morons” and “imbeciles”).

divergent. According to one of the most quoted of such workers, Dr. Goddard of Vineland, 66 per cent of the inmates of the Newark Detention Home, New Jersey, are "distinctly feeble-minded." According to another, a psychologist of New York, "probably 80 per cent of the children in the Juvenile Courts in Manhattan and Bronx are mentally defective." Later estimates are more cautious and conservative, but the majority still fluctuate between a proportion of one-half and one-third.<sup>8</sup>

With this opinion, or with this extreme formulation of it, my own experience fails to concur. Both facts and figures seem in recent studies to have been wildly overstated. The exaggeration springs chiefly from two kindred sources, from an interpretation of deficiency that is far too broad, and from a criterion of deficiency that is far too narrow. The criterion

---

<sup>8</sup> The highest figures that I have encountered in a careful search through the literature are those of W. J. Hickson, "The Psychopathic Laboratory of the Municipal Court of Chicago," *Third Annual Report of Probation Office, Cook County, Illinois* (1914), who finds "85.8 per cent of our [female] cases are distinctly feeble-minded" and "84.5 per cent of boys under arrest are morons." Figures near or over 70 per cent are given by Renz at Columbus (Ohio), Pyle at Chillicothe (Missouri), Hickman at Plainfield (Indiana), Kohs at Chicago (Illinois), Gifford at Newark (New Jersey), the Children's Commission at Manchester (New Hampshire), the State Board of Charities at Richmond (Virginia), Morrow and Bridgman at Geneva (Illinois), McCord and Bridgeford at Albany (New York). Alive to the countless pitfalls that beset the inexperienced in their facile deductions from these tests, one or two of the latest American writers have dropped to a figure much below those of the earlier enthusiasts: J. Burt Miner, for example, gives a proportion of 7.3 per cent (*Deficiency and Delinquency*, Warwick and York, 1918, p. 126; see the whole of his chapter on "Delinquents testing Deficient").

Of the vast literature upon the intelligence of delinquent boys and girls, and in addition to those I have just cited, the following publications deserve mention as among the most recent, the most scientific, and the most suggestive. Truman L. Kelley, *Mental Aspects of Delinquency* (University of Texas, 1917); J. Harold Williams, *The Intelligence of the Delinquent Boy* (*Journal of Delinquency* Monographs, No. 1, Whittier State School, Research Department, 1919); Augusta F. Bronner, *A Comparative Study of the Intelligence of Delinquent Girls* (Columbia University, N. Y., 1914). A useful "Bibliography of Feeble-mindedness in Relation to Juvenile Delinquency" will be found in *Journal of Delinquency*, V (1916), iv.

consists almost exclusively of tests, and the tests are almost wholly scholastic or linguistic. At the same time, the interpretation of deficiency is implicitly extended to embrace not only persons who are truly defective in native intelligence, but often pupils who are simply dull or backward in school work, sometimes, too, sheer nuisances who are merely unbalanced or unmanageable, and not infrequently all who might be dubbed defective morally.

Mental deficiency is a technical term. It has now a fairly well marked connotation. And before a person can be placed within that category, certain distinctions must be observed. It is important—indeed, it is tacitly imposed upon us by the terms of the relevant statutes—that we should discriminate, first of all, intellectual defect from moral defect and, secondly, intellectual defect in children from intellectual defect in adults. In this chapter we are concerned solely with mental defect in the more usual and limited sense—with what may be termed intellectual deficiency, that is, defect of inborn general intelligence. And in dealing, as we are throughout this volume, principally with children, we have to employ the somewhat higher border line laid down for cases of school age.<sup>9</sup>

Taking the line of demarcation generally adopted in this country in certifying children for the special school, I find that of the juvenile delinquents whom I have tested with the Binet-Simon tests, 8 per cent and no more are mentally defective—8 per cent, that is to say, are children who are backward in intelligence by at least three-tenths of their ages (see Table XVI).<sup>10</sup> When ten years old, they respond like normal chil-

---

<sup>9</sup> Of the diagnosis of mental deficiency I hope to treat in another volume. Meanwhile, I may be permitted to refer for a more detailed discussion of the subject to my article on "Delinquency and Mental Defect" (*Brit. Journ. Med. Psychol.*, III (1923), iii, pp. 168-178) and to my book on *Mental and Scholastic Tests*, particularly the section treating of juvenile delinquency (pp. 184 *et seq.*).

<sup>10</sup> That my figure is by no means too low is indicated by the figures from London industrial schools. At the end of 1922 there were in the *ordinary* industrial schools 2,162 children, and in the *special* industrial schools for the mentally defective only 85. This is a proportion of only 3.8 per cent.



TABLE XVI.—PSYCHOLOGICAL CONDITIONS: INTELLECTUAL

	DELINQUENT					NON-DELINQUENT		
	Boys		Girls		Average	Boys	Girls	Average
	Major Factor	Minor Factor	Major Factor	Minor Factor				
<i>1. General</i>								
Mental deficiency <sup>1</sup>	5.7	2.4	2.7	4.1	7.6	1.0	1.5	1.2
Natural dullness <sup>2</sup>	4.1	[22.8]	4.1	[25.7]	[27.9]	[10.5]	[9.0]	[9.7]
Educational backwardness <sup>3</sup> .....	1.6	60.2	—	56.8	59.9	16.0	15.5	15.7
Superior intelligence <sup>4</sup> .....	—	3.3	—	1.4	2.5	9.0	8.0	8.5
<i>2. Specific</i>								
Special disabilities								
Reading.....	—	3.3	—	—	2.0	0.5	—	0.2
Arithmetic.....	—	2.4	—	5.4	3.5	—	2.5	1.2
Miscellaneous <sup>5</sup> ...	—	1.6	—	2.7	2.0	—	—	—
Special abilities:...								
Verbalism.....	—	4.9	—	2.7	4.1	1.0	2.0	1.5
Imagination.....	—	2.4	—	5.4	3.5	4.5	6.5	5.5
Manual dexterity.	—	2.4	—	—	1.5	3.5	2.5	3.0
Total.....	11.4	82.9	6.8	78.5	90.9 <sup>6</sup>	35.5	38.5	37.0

<sup>1</sup>All feeble-minded cases in the sense of the Elementary Education (Defective and Epileptic Children) Act—mental ratios being between 50 and 70 per cent.

<sup>2</sup>Marked inborn retardation in general intelligence not amounting to mental deficiency—mental ratios between 70 and 85 per cent. All the dull are also backward. Only those instances, therefore, where dullness formed a major factor are included in the total, the remainder falling under the next category.

<sup>3</sup>Marked retardation in educational attainments—educational ratios of 85 per cent or less. The numbers for dullness, but not for deficiency, are included in those for backwardness; but backwardness is only entered as a major cause where dullness was not a major cause.

<sup>4</sup>Mental ratio over 115 per cent.

<sup>5</sup>Marked defects of manual dexterity, memory, or attention, without corresponding defect or intelligence.

<sup>6</sup>As usual, this figure is calculated as being the weighted average of the totals for boys and girls respectively, not as the total of the column of averages. The slight discrepancy here resulting from the two modes of calculation is due to the partial overlapping of the factors of "dullness" and "backwardness."

dren of seven or less; and, when fully grown up, they will, at best, hardly attain to the level of a normal child of ten and a half.<sup>11</sup> Among girls, particularly among older girls drifting into sex delinquencies, the proportion of defectives is perceptibly higher than it is among boys; and among convicted adults,

<sup>11</sup>The borderline, so far as tests are concerned, is for children under sixteen a mental ratio of 70 per cent; for adults one of approximately 50. Thus, on leaving the special school at sixteen, many are virtually decertified. A fuller discussion of these lines of demarcation and their limitations will be found in the work just cited (*Mental and Scholastic Tests*, pp. 167-74).

particularly the habitual inmates of the prison, it may be higher still.<sup>12</sup>

Placed beside the sensational statistics from America, my own percentage must seem low. In itself, however, it still reveals among the delinquent population a proportion of mental defectives five times as great as among the school population at large. Mental defect, beyond all controversy, therefore, is a notable factor in the production of crime.

Further, wherever it does coöperate, it plays the part almost without exception, not of a mere accessory condition, but of a principal, if somewhat negative, cause. Its mode of working is plain. The defective child is without the necessary insight to perceive for himself or to hold effectively in mind that what tempts him is dishonest, and that dishonesty is wrong—base in itself and bad policy in the long run.

This is seen clearly in the following examples. A little boy of eight was brought to me as an incorrigible thief. On testing him I found that his mental age was only five.<sup>13</sup> He could name

<sup>12</sup> For unconvicted adult prisoners the proportion suggested by Dr. Norwood East, the Senior Medical Officer at H.M. Prison, Brixton, is 5 per cent. But it should be remembered that, among adults, a somewhat lower borderline is accepted (see previous footnote). Dr. East holds that "it is probably a matter of general agreement at the present time that the largest figures [given in evidence before the Royal Commission of 1904, and ranging up to 18 or 20 per cent] are inaccurate" (*Brit. Journ. Med. Psych.*, III (1923), iii, p. 154).

<sup>13</sup> Harold J. *Age*: 8½. *Home Circumstances*: Father, dock laborer (wages averaging 25s.). One room (rent, 4s. 6d.), clean and fairly well kept.

*Family History*: Father and mother ill educated, but by no means below the average level of intelligence obtaining in their social class. Mother, tubercular, too weak to work. No other children living (two died in infancy). No other case of mental deficiency in the family on either side. No further record in the family of physical disease relevant to the child's condition.

*Physical History and Condition*: Backward from birth. First incisor teeth not cut until 11 months old. Walked at 18 months. Talked at 2 years. Excluded from school for 9 months for scabies (regarded by mother as sole reason for child's backwardness). Diurnal incontinence. Somewhat undersized and pale, but health otherwise normal. Height, 114 cm.; weight, 20.4 kg. Circumference of head, 51.4. Lobeless ears; no other stigmata.

no coins except a penny, and of their use and relative value he had little or no conception. A new halfpenny which was big and bright he preferred to a sixpence which was smaller and did not glisten, and started gleefully appropriating, as gifts set out for his acceptance, my cards, my pictures, and my testing boxes beneath my very eyes. No matter what piece I showed him, silver or copper, a farthing or half-crown, his response was invariably the same; murmuring "penny" with a sheepish smile, whether asked for the name or not, he would make one sticky grab for the coin and clutch it in his fist. Once only had he spent a stolen shilling upon sweets; and then he had received the suggestion from another child: even so, he had been too dull to profit by the lesson, and take his subsequent finds to the sweetshop. His pockets bulged with accumulated rubbish—buttons, corks, cigarette cards, a bit of scarlet ribbon, two sticks of chalk, three pencil ends, and a knob of shiny coal. It was clear, therefore, that, though solemnly charged with the theft of money (for the rest of his plunder was of no consequence), he had simply been picking up, with a reaction as automatic and as invincible as that of a magpie, the pretty, glittering, pocketable pieces that he had seen lying conspicuously about.

Tommy K.,<sup>14</sup> an older boy of nine and a half, was brought

*Intelligence:* Mental age (Binet tests), 4.9; (performance tests), 5.3; (average mental ratio, 6.2). Reading, 4.2. Arithmetic, 4.0. Drawing, 4.5. Handwork, 5.0.

*Temperament:* Active, but not markedly unstable.

*Recommendation:* Transference to a special m.d. school.

*After-history:* School reports (six months later): "seems an acquisitive type, but never steals money, or food"; (two years later): "has grown out of his collecting mania, and is making good progress in practical work. His mother says he is a good boy at home, and can be trusted to go shopping."

<sup>14</sup> Age: 9½. *Home Circumstances:* Father, porter in meat market (wages 26s.). Mother, occasional charing (wages averaging 6s.). Two slovenly and overcrowded rooms (rent 7s.). Lack of care and control.

*Family History:* Father, extremely dull and illiterate. Mother, emotional but not markedly dull. Paternal cousin attending special m.d. school. Maternal grandmother and aunt died of consumption. Three younger children, all dull and backward, but not mentally deficient.

to me for persistent truancy and wandering. His odd appearance was enough to class him at first sight. In looks he was a typical slum monkey. His sloping forehead, his diminutive snub nose, his prominent jaws and lips, were suggestive of the muzzle of a pale-faced chimpanzee; and his scarcely human gaze, half startled, half perplexed, had something of the appealing wistfulness of that quaint creature. His tattered clothes and grimy shirt showed that he and his parents possessed little family pride. His boots and stockings were tied up with string; he was without even the scarf or muffler that the collarless cockney affects; and every button that was not fundamental was either lost or undone.

His home was equally shiftless. He lodged in a dilapidated block of city dwellings, with all London roaring by at the bottom of his street. On the way to school or back again, he would meander off, like a stray kitten, to be found an hour or two later by his anxious relatives or the policeman, listening to a cornet player half a mile away or gaping vacantly at a cheap jack selling clockwork beetles from the curb. Every test bore out the first impressions. His mental age was less than six; but, being well behaved in the ordinary classroom, he had never been nominated to a special school for the defective. On inquiry I learnt that his vagrancy had started with some suddenness nine months before. Tommy, of course, attended a senior department. But he had a younger brother who was then barely seven years old; and it appeared that, so long as this second child was attending the infants' department, the mother had

---

*Physical History and Condition:* Broncho-pneumonia in infancy. Walked and talked at 2 years. Whooping cough, measles (twice), scarlet fever. Otorrhœa at 7: still a little deaf in right ear. Constant nasopharyngeal catarrh. Numerous so-called stigmata (probably in part attributable to poor nutrition during infancy and to continual respiratory obstruction). Four teeth badly decayed; no permanent teeth beyond three molars. Height 123 cm.; weight, 24.5 kg. Circumference of head, 52.1 cm.

*Intelligence and School Attainments:* Mental age (Binet tests), 5.9; (Performance tests), 5.5; (average mental ratio, 59). Marked defect of auditory memory. Reading, 4.5. Arithmetic, 5.0. Drawing and hand-work about 4.5.

*Temperament:* Unemotional and apathetic.

regularly escorted both of them to and from the gates of the playground. As soon as the younger was also promoted to the upper school and so attained the status of a "big boy," then, by the tradition of the neighborhood, such protection was thought superfluous and even an indignity; never did it occur to any one that, in mind and character, the older child was still an infant. And thus it was that Tommy's roving tendencies first found a chance to manifest themselves.

The chief thing needful was a simple explanation to his mother. It was impressed upon her that although Tommy had the size of a boy of ten, it was impossible to treat him as a "big boy" mentally, and that he still needed a constant convoy, just like a baby of five. When this was provided, no more complaints were received, and ten months later the child was transferred to a special school where the care that was lacking at home could be in some measure supplied.

Older children who are defective may practice almost any of the commoner crimes committed by normal children; and sometimes display unexpected cunning, both in carrying them out and in eluding observation. In general, however, their delinquencies, like all their transactions, bear the hall-mark of inefficiency. And, in a defective adult, the stupidity of the offense is often of itself diagnostic. Many of their follies are enacted in circumstances that must lead to inevitable discovery, and others are so simple, senseless, and fatuous that to entitle them crimes at all is a flattering hyperbole.

Of these older cases nothing could be more typical than the story of a young Londoner described elsewhere by my colleague under the Council, Dr. F. C. Shruballs. The youth, though nearly twenty, had a mental age of only five. He had attended a special school, but had been considered too dull to complete his education there. On leaving he had found work of a light mechanical kind, and being as willing as he was witless, had succeeded in retaining his place. He was the sole support of a widowed mother, and it had been his custom to take home his weekly wage in a small wallet. One day he chanced to see certain ladies in the street holding up bags to passersby, who dropped coins therein with a surprising readiness. It looked



a simple mode of earning. So, returning home, he fetched his wallet, and stationing himself in the main road of the district, held it out with a mumbled appeal, as he had observed the others do before him, only to be seized by a constable ten minutes later for the fraudulent pretense of collecting money for a flag day—a thing he had probably never heard of and assuredly never understood.

*The Degree of Deficiency and Its Relation to Particular Offenses*

The intelligence of defective criminals is, on an average, slightly higher than that of defectives who commit no crime. To be successful, even in wrongdoing, needs a certain minimum of sense. Idiots, indeed, are never, and imbeciles are seldom, arrested for breaking the law. Of these low-grade types, most are early removed to institutions, unless already under adequate control. When troublesome, their misbehavior is simply that of an ill-trained or untrainable animal, although, owing to their physical development and physiological maturity, it may appear far more immoral than that of a normal infant of the same mental age. More often than not, their conspicuous want of common sense is combined with an unusual lack of mental energy. Imbeciles are apathetic rather than excitable, and with a few startling exceptions, their instincts, like their abilities, are weak, withered, and abortive. Hence, delinquent defectives are found chiefly within the higher or feeble-minded grades, such as alone are admitted to the special schools, and even among these they belong generally to the superior types.<sup>15</sup>

The degree of the defective's intelligence bears an appreciable relation to the type of offense he is most prone to commit. The dullest are those reported for wandering, cruelty, and destructive mischief; those who steal, though varying widely, have, on an average, a somewhat better mental standing; and female defectives reported for sex offenses show the highest intelligence of

---

<sup>15</sup> In my own list of cases I find that defective delinquents have an average mental age that is about half a year higher than defective school children who are not delinquent; and in the special industrial schools the mental level at every age is higher by the equivalent of four or five months than it is in the special day schools.

all.<sup>16</sup> This order is of itself suggestive. So far as it goes, it is roughly parallel to the order of the successive emergence and of the ultimate control of the various instincts and emotions that are at work. The normal child reveals symptoms of anger and a disposition to rove long before he shows signs of acquisitiveness, and he shows signs of acquisitiveness long before his sexual functions have ripened and matured. Among adults whose crimes are associated not with *amentia*, but with *dementia*—whose minds, therefore, are not undeveloped from the outset, but after duly developing have begun to decline, and whose intelligence is thus not upon the slow upward path of the defective but upon the steep downhill slope of the insane—among these much the same forms of misconduct make their successive appearance, but they do so in the opposite order. In diseases like general paralysis, where there is a gradual decay of the nervous system, the patient (as is often observed) loses his accumulated knowledge in a reverse order to that in which it was acquired; he forgets first his most recent engagements, then his older acquaintances, later on, the languages and mathematics that he learnt at school, and later still, the power of speech; until, towards the end, his mental life is reduced to the simplest perceptions of sight and hearing which he enjoyed as a new-born baby. In the same regressive fashion he forfeits, step by step, the control of his various instincts; and that, too, once more in the inverse order of acquirement. He turns, first of all, into a reckless spendthrift; then into a sexual profligate; presently, perhaps, he is arrested as a thief or missed from home and caught aimlessly wandering; a few weeks later his true condition is declared by frantic bursts of maniacal violence and destruction; and at last he loses even the habits of decent cleanliness which he was taught as an infant in arms. The old course is traversed, but in the opposite direction; and just as nature builds upwards from the basement to the roof, so when she

---

<sup>16</sup> If we confine our instances to those who are no longer children and so eliminate the influence of physical growth, the same differences of mental level still appear. Among adolescents and adults the defective wanderer has an average mental age of barely seven; on the other hand, the defective sex offender, one of nearly nine.

destroys she starts with the top story and works steadily downward to the foundations.<sup>17</sup>

### *Various Types*

There are among delinquent defectives four or five broad types which it is useful to discriminate.

1. *The Young and Passive*.—First, and most commonly when young, the defective may be a mere tool and puppet in the hands of others more astute. He is highly suggestible, and falls a facile prey to criminal ideas or vicious proposals dropped into his mind by a bolder and more inventive accomplice. The master spirit himself may be shrewd enough to avoid discovery or to escape capture, and even to abstain altogether from putting his own guilty fingers to ventures that might implicate him in personal risks. The foolish jackal is nearly always trapped.

2. *The Older and More Active*.—But, secondly, when somewhat older, the defective may assume a more active rôle. Little more than a babe for ability and wisdom, he may, in his passions and in his sordid knowledge of the street, be almost a full-grown man. Yet, both in school and out of it, by virtue of his puerile intellect, he is still forced to associate with playmates much younger and much smaller than himself. These, by his greater strength and size and by his longer worldly experience, he can often intimidate or provoke into deeds that their own little minds would never have imagined or dared. The defective is not always the harmless creature he is sometimes thought.

3. *The Adolescent and Adult*.—After the age for leaving school, which, with the defective, is sixteen, he is found carrying on his mischief more often alone; his notorious stupidity of itself is enough to make him a useless, if not a dangerous, confederate. Occasionally, indeed, an artful instigator may still exploit him as a catspaw to snatch chestnuts from the fire; but the prudent clique soon drops him. The grown-up defective is left usually to himself. An adult among children, he is a child among adults, and can mix with no one on terms of equality.

---

<sup>17</sup> See, for a clear statement of the parallel, Stoddart, Symposium on "Delinquency and Defect," *Brit. Journ. Med. Psych., loc. cit. sup.*, p. 191.

*C'est que l'homme est toujours enfant;  
C'est que l'enfant est toujours homme.*

Men of his own size despise him; smaller lads are afraid of him; all know him to be odd. His lonely, isolated life deprives him of that natural curb, of that silent supervision and restraint, of all that interchange of views, advice, and criticism, which equal intercourse affords and which are doubly needed by his slow and shallow mind. With nothing to bind him to society, it is small wonder that he drifts into antisocial ways.

4. *The Unstable.*—Most of the defective youths and nearly all the defective girls who are reported for anything beyond mere technical offenses prove also to be more or less unstable in their temperament. It is their emotional nature, as we shall later on perceive, that supplies the main active ingredient in their criminal explosions. This instability, moreover, with the older defectives, makes it additionally hard for them to find and keep a decent occupation. For such rough and cheaply paid work as their blunt wits can perform, an employer will put up with a good deal of simplicity, but he will stand no flares of temper or passion.<sup>18</sup> Defective youths, too, of an unstable disposition show a perilous susceptibility to alcohol. Indeed, given appropriate opportunities, a deficient person of whatever type falls an easy prey to intemperance and to all the vicious habits which intemperance gathers in its train.

5. *Defectives with Specialized Talents.*—But whether young or old, stable or unstable, the defective is not always a self-confessed fool in his offenses. Along narrow grooves and in definite directions, many reveal an acuteness that seems nearly or entirely normal. Their accomplishments may at times quite mislead the layman in his judgment of their mental state. Fail-

---

<sup>18</sup> See the interesting classification of defective delinquents based upon the degree of their emotional stability given in Dr. Shrubsole's tables (*Brit. Journ. Med. Psych., loc. cit. sup.*, p. 183). It is noteworthy that the female defectives in spite of their ill-balanced nature are often in some more or less regular employment; and that their chief offenses are not thieving or violence, but sexual misconduct. The more stable male defective seems to take to stealing, wandering, and begging, chiefly at those periods when, owing to the condition of the labor market, even low-grade employment is not to be had.

ing, as he does, to distinguish a special from a general capacity, he mistakes tricks for skill, craft for reasoned cleverness; and too often the technical smartness of the professional cracksmen is held to absolve him from any imputation of a defective mind. But low cunning in a limited sphere is no proof of high intelligence. Nor is a widespread deficiency at all times incomparable with a narrow line of talent.

The aptitudes displayed are of very various kinds.<sup>19</sup> Some defective delinquents evince a special oral or linguistic talent, and as talkers are fluent, plausible, and inventive. Others have a special motor ability, and are deft to execute such simple sleight of hand as is requisite for breaking into shops or for picking other people's pockets. Many, again, are normal or even precocious in the development of certain instincts—for example, in those hereditary impulses that quicken personal vanity or sexual desire. In a dull mind these specialized abilities and premature emotions are like matches or razors in the hands of a baby; useful gifts in themselves, they are instruments of danger when blindly applied.

### *The Negative Influence of Mental Defect*

There is, however, beyond question an upper limit to the criminal ingenuity of the truly feeble-minded. There are certain crimes which a defective of whatever age can hardly ever carry through. He seldom forges, for he can scarcely write and barely spell. He seldom embezzles, for the arithmetic of all but the simplest transactions in money lies wholly beyond his reach. Fraud, too, where it rises above mere verbal misrepresentation, needs planning and resource, and even a coiner or receiver must have more sense and wiliness than will suffice for the practices of the petty thief. On the other hand, there are certain faults to which the half-witted seem particularly prone. Among children reported for vagrancy, defectives are nearly three times as numerous as normals. Among boys reported as beyond parental control, the percentage of defectives is nearly as high. Among adolescent defectives, sexual mis-

---

<sup>19</sup> See page 348.



demeanors recur out of all proportion. To add violence to robbery is eminently characteristic of the deficient mind, and among murderers defectives are twice as common as among those whose personal violence takes a less extreme and desperate shape. Malicious damage to property is with the feeble-minded a frequent ground of conviction: the village idiot fires a haystack just to revel in the roaring blaze; another will set flame to his employer's offices out of sheer malevolent revenge—both, plainly, less sapient forms of arson than burning insured property for private gain. With adult defectives, indecent assaults upon children and sexual offenses of an unnatural type are somewhat commoner than rape upon persons of their own age and size. Generally, therefore, the misdeeds of a defective mentality are those of blind and childish impulse rather than of intelligent deliberation. }

In truth, many of the so-called crimes of the feeble-minded delinquent should hardly be accounted crimes at all. Low-grade defectives, as we have seen, are continually charged with wandering. But the fact that he is found far from home and astray in a distant street may be due to no conscious resolve to run away, but solely to the failure of what used to be termed "the faculty of spatial orientation"; the child simply lacks sufficient sense to discover where he is, to remember how he got there, or to take the necessary steps for finding his way back: he is as helpless as a lost baby at a fair. Similarly, the cases of indecent exposure may arise from no set intention to offer an affront or to shock. The child merely fails to appreciate the ordinary social conventions and to realize the exposed situation in which at the moment he may chance to be. Even where some spice of culpable malice has entered into his transgression, its real seriousness may still result from nothing but want of foresight, heed, or understanding. A girl of thirteen was sent to me for what was described in the report as "gross cruelty and a homicidal attack on another child"; she had "pushed it into the fire." I found she had a mental age of seven. The circumstances of the act were retailed by the mother. The girl had been left in the kitchen to mind a baby cousin to whom she was devotedly attached. The baby, sitting in a high chair

near the fender, commenced to scream. The girl applied the traditional treatment of her class: she gave it a little shove or shake, calling out in a menacing tone, "Do hold your noise." For a moment the baby was silenced, but presently the crying and the scolding were renewed. On the third occasion the girl, growing more and more exasperated, administered a somewhat harder push; the chair toppled over; the baby fell in the grate; and the mother, hearing a crash and a shriek, rushed in to find the girl standing stupidly over the burning infant, still adjuring it to hold its noise else she'd "fetch its mother."

From first to last, as must now have been perceived, the influence of intellectual defect as a pre-condition of crime is negative rather than positive, permissive rather than provocative. Of itself, mere lack of intelligence can scarcely furnish a motive for wrongdoing. If a delinquent is genuinely defective, the criminal suggestion must either first have reached him from some outside source—a base companion or a "crook film"—or else have developed from some inner instinct or impulse, such as easily expands, in a head that is empty but excitable, to an excessive and uncontrollable passion. The deficiency itself simply removes some of the usual checks, which, based on prudence and rational insight, keep a more normal mind from giving rein to such promptings.

### *Treatment*

It is essential to a just treatment of the defective criminal to deal with him not as a criminal, but as a defective. The result of the present policy may be illustrated by one salient case. The following is the record of a mentally defective boy who at the time of his first appearance was only ten years old:

Date	Offense	Treatment by Court
Nov. 3, 1917	Theft.....	Admonished
Jan. 12, 1918	Malicious mischief.....	Admonished
Mar. 26, 1918	Attempted housebreaking.....	Admonished
July 24, 1918	Robbery.....	Birched: 8 strokes
Jan. 19, 1920	Theft.....	Proceedings dropped
May 8, 1920	Housebreaking: theft.....	Admonished
Mar. 2, 1921	Theft.....	Proceedings dropped
Apr. 2, 1921	Housebreaking: theft.....	Proceedings dropped

At the age of ten this boy must have possessed the understanding of a baby of about five or six—no more. What meaning could the three successive admonitions of the court have conveyed to his infantile mind? Had he been tested and properly dealt with after his first offense, seven reappearances and doubtless twice as many actual crimes would have been prevented.

According to the official returns for the latest year available (1923), out of all the children charged before a juvenile court only 0.10 per cent were committed to an institution for defectives.<sup>20</sup> It is true that, during the eight preceding years, the number so dealt with rose from one solitary individual in 1914 to as many as 29 (out of nearly 30,000 charges, however) in 1923; and, no doubt, among the many who were dismissed or otherwise disposed of, a few were in the end placed under suitable control. But in case after case, as experience shows, the defect has been neither diagnosed nor even considered.

1. Psychological Examination.—The first requisite, therefore, is to see that the offender be scientifically examined and tested by a qualified expert. When so large a proportion of the juvenile delinquents appearing before the court verge on the border of mental deficiency, and when a considerable proportion fall decidedly below it, there is plainly a pressing need, if only on this one ground, for the coöperation of a trained psychologist; practically every second case must call for technical testing. Special psychological experience and special psychological methods are needful more particularly, first, to distinguish the genuinely defective from those who, from accidental causes or from merely physical conditions, appear so dull as to defy discrimination, except by expert scrutiny; and, secondly, to discover any added disorder of mind, temperament, or character, which, in a defective child, must of necessity be doubly hard to detect.<sup>21</sup>

2. Systematic Ascertainment of All Mentally Deficient Cases.—If, throughout the country, every case of mental deficiency were early ascertained and adequately provided for,

---

<sup>20</sup> Home Office: *Report on Works of the Children's Branch*, 1924, p. 69.

<sup>21</sup> See Appendix II on "The Psychological Clinic."

then the number of defectives who bungle into crime would rapidly diminish. The need for a special psychological examination of court cases would not thereby be abolished; but such work would be greatly simplified and helped.

By the Mental Deficiency Act, 1913, the local education authority has the duty of ascertaining what children within its area are mentally defective. From the figures published, however, it is manifest that the duty is very variously performed. One area reports that the defective children within its boundaries amount to as many as 1.61 per cent; another reports only 0.07 per cent. That the local incidence can really differ in this way is beyond belief. If, for the proportion of defective children to normal, we take the lowest conceivable percentage, namely, 1 per cent, then it would follow that there must be in this country at least 60,000 defective children. Of this vast number, less than one half (about 29,300) have been actually ascertained; and scarcely a quarter (14,670) are attending certified special schools.<sup>22</sup> Where the work of ascertainment is thorough, and where a representative of the local education authority is regularly in attendance at the court, the court should have no difficulty in discovering whether the child charged has been certified already and whether he is on the roll of a special school for the defective. In London this is, I believe, the invariable procedure; and the magistrate's decision

---

<sup>22</sup> See *The Health of the School Child* (Annual Report of the Chief Medical Officer of the Board of Education for 1923), p. 62. According to my own inquiries, among the children attending Council Schools in London, approximately 1½ per cent of each age group are mentally deficient (L.C.C. Report on *Mental and Scholastic Tests*, p. 168). In practice, however, the diagnosis is seldom made until the child has passed up from the infants' school. Hence, the proportion of children in special mental deficiency schools to the total number of children of all ages upon the roll is in London about 1.25 per cent. A similar figure, or one but little below, appears to hold good for most industrial areas. It is unlikely that rural areas contain a smaller proportion; the careful investigation of Dr. Bowes in Wiltshire, for example—an investigation carried out by means of psychological tests duly checked—yields a figure of nearly 3 per cent. ("Mental Defect in a Rural Area," *Lancet*, 1924, Aug. 16, pp. 313 *et seq.*) The percentage suggested in the official report on *The Health of the School Child* (0.86 per cent, *loc. cit.*, p. 63) is, to my mind, unquestionably too moderate.

is guided accordingly. But in other districts, as a recent official inquiry has shown, the defect often remains undiscovered until the child has been sentenced to some punishment or institution that requires a special examination: eight or nine years he may have passed in a public elementary school, yet his condition may never have been diagnosed.<sup>23</sup>

3. Special Day Schools for the Mentally Deficient.—From its very nature, genuine and general mental deficiency is incapable of cure. Nevertheless, since its influence is so frequently a negative one, much leniency may be extended toward the first offender. If young, he should be transferred to a special school. The additional supervision that this will entail, together with the association of the child with companions whose mental level is nearer to his own, will often of itself suffice for an immediate improvement in his ways.<sup>24</sup>

4. Home Supervision.—The conditions obtaining out of school, however, are always of crucial importance. The good done in the classroom may be altogether undone in the home or in the street. If the child's own family cannot arrange to superintend him during his hours of liberty and recreation, then the very fact that he is kept during lesson time fully occupied and continually watched, puts him all the more at the mercy of the first mischievous temptation when he is released and left to himself. Defective delinquents, therefore, require unremitting vigilance out of school as well as within. There

---

<sup>23</sup> See *Board of Education: Report on Juvenile Delinquency, 1920*, p. 12.

<sup>24</sup> The war, with its consequent effects both on building and on finance, has rendered it impossible hitherto to provide throughout the country sufficient special schools and institutions for defectives. Where accommodation is lacking, the lack is not of itself a sufficient ground for postponing the duty of ascertainment: and often provisional accommodation may be found either in classes for dull and backward children or in occupation centers such as those already established for ineducable defectives. In any event, such cases should be known, visited, and kept under observation; and in due course, if the need appears, they should be notified to the Mental Deficiency Committee. (See Article 5 of the *Mental Deficiency (Notification of Children) Regulations, 1914*; and, on the provision for mentally defective children not in special schools, see the Board of Education's *Circular to Local Authorities, 1924, No. 1341*.)



is now a large variety of ways in which such supervision can be exercised. It can be carried out by school nurses, by paid welfare workers, by officers of the care committees, by the local branch of the Central Association for Mental Welfare, or by other voluntary organizations. Whether the child be attending a special school or not, one or other of these plans should be put into action in all cases where conduct gives ground for anxiety.

Older children, who are past the school-leaving age and whose defect and condition are not grave enough for them to be transferred to an institution or to other guardianship, will usually remain at home, waiting perhaps for some simple employment to be found for them. In such cases, wherever there is the least likelihood of delinquency or misbehavior, supervision should be diligently continued. If no situation has been obtained for the child, he should attend an industrial occupation center, where such occupation centers exist. At Leeds and elsewhere workshops have been opened specially for cases of this type, and occupations like rug making, boot repairing, and chopping firewood, for all of which a wage is given, have been arranged with considerable success. No doubt, in the near future, for defectives of all ages who are not in attendance at a school, centers of this kind will be more widely established.<sup>25</sup>

---

<sup>25</sup> When a mentally defective child reaches the age of sixteen, the local education authority has the power to notify him either for guardianship or for institutional treatment, but not for supervision. It is the practice, however, of many authorities to supply, either to the Mental Deficiency Committee or to the local branch of the Central Association for Mental Welfare, the names of children who have passed beyond the age for special school accommodation and who are still in need of continued vigilance. Such an arrangement has no legal force; but it provides a useful means whereby friendly contact on a voluntary basis can be maintained between the children and responsible visitors; and has definitely been recommended by the Board of Education in Circular No. 1341. I may add that, in notifying defective cases, whether for supervision, guardianship, or institutional treatment, the child's intellectual level forms but one of many factors that should be taken into account. Besides the facts reported by the teacher and the medical officer, regard should also be paid to the child's home circumstances and general environment, and in particular to such weaknesses of character or temperament as he may have shown outside the school as well as within.

5. *Residential Institutions for Older Defectives.*—Where supervision cannot be supplied by the parents or guardians, the offender, particularly if approaching adolescence, and above all things if a girl, should be segregated in some residential school or colony. There is no other measure. Permanent segregation is in most cases to be preferred. But permanency is not always indispensable. After a spell of training in a suitable institution, the high-grade defective of stable temperament who is sent in due course to a country farm will usually do well, despite the worst of previous records.

A few certified institutions accept so-called moral imbeciles and specialize in training cases of this kind. One or two—for instance, St. Catherine's Home at Durham—stipulate that every entrant must be under the age of eighteen. Some, indeed, make it a rule to exclude certain classes of delinquent or difficult defectives—*e.g.*, criminals, fallen women, runaways, or so-called moral imbeciles; but the majority of the larger certified establishments accept court cases of almost any grade or type.

By the provisions of the Mental Deficiency Act, 1913, the Board of Control "may establish and maintain institutions for defectives of dangerous or violent propensities."<sup>26</sup> There are at present two State institutions so established, one at Rampton in Nottinghamshire and the other at Warwick. The defectives sent to these two places are, for the most part, patients who cannot be managed in other institutions: if offenders, they are usually recidivists; first offenders, as a rule, are more suitably sent to voluntary homes or certified houses. At Rampton there is accommodation for about 370 cases; the patients are of both sexes, of all ages over sixteen, and of every level of intelligence; they are said to include "persons with convictions for almost every crime"; but, for the most part, those selected for removal are the dangerously violent or the grossly immoral.<sup>27</sup> To

---

<sup>26</sup> Section 35.

<sup>27</sup> *Tenth Annual Report of the Board of Control* (for 1923), p. 62; see also pp. 59-65, and pp. 365 *et seq.* A similar experiment was made at Farmfield. The report states that, of defective cases discharged, the "high grade unstable" class "contains the highest percentage of failures and is the only class that contains any success" (p. 59). The fact that success is achieved at all may prompt a query whether the successful

separate the younger and improvable cases from those that are hopelessly vicious and untrainable is a further step of much importance; in this direction an effort has recently been made at Warwick. To the institution at Warwick about thirty of the younger girls and women have lately been transferred from Rampton.

6. *Special Industrial Schools for Defective Children.*—As part of the commendable progress made during the last few years in sub-classifying children committed for prolonged detention, there have now been set apart as many as ten residential schools certified for special cases and receiving boys or girls who are mentally deficient.<sup>28</sup> To such a school should be transferred all those who are either too defective in intelligence for the ordinary industrial school or too unstable in temperament and too dangerous and vicious in disposition for the ordinary institution for non-delinquent defectives. At many of the ordinary industrial schools the managers still exercise their right<sup>29</sup> of refusing to accept a child, whenever he is known to be defective; and although the Mental Deficiency Act has opened a door for relieving them of those who are ineducable, the accommodation as yet provided is far from equal to the number of cases needing special provision. When the time comes for the defective delinquent to be released from the school or reformatory to which he has been sent, after-care and close consideration of further measures are in his case doubly necessary. Instance after instance could be quoted where a feeble-minded boy has been shut up in a certified school for a term of years, and then, so soon as he has been set free, has repeated his offense.

7. *Hostels.*—We have seen that a large proportion of defective delinquents are of a very high grade—boys and girls

---

case was truly defective, since, as the Report observes on the following page (p. 60), "there is no doubt that amentia is a permanent condition." Many perhaps were cases that, in the nomenclature I have here proposed, were "dull" and "unstable," but not "intellectually defective"; a few perhaps were "temperamentally defective" as well as "dull." (See below, Chapter XI.)

<sup>28</sup> A list of these schools will be found in Part IV of the *Directory of Certified Schools* issued by the Home Office (1924), pp. 34-40.

<sup>29</sup> Under the Children Act, Sec. 52.

near the threshold of puberty and just on or just below the borderline for certifiable deficiency. They are, therefore, cases that might conceivably have escaped certification altogether, had it not been for some infringement of the law. Their original fault may have been a purely technical one—wandering, begging, accidental damage, or obstruction—due not so much to vicious instincts as to lack of knowledge and judgment. If left at large, they are likely to transgress again; and so flounder on from bad to worse. If removed to a reformatory, they may be demoralized still further by the inherently depraved and the habitually corrupt. If confined in an ordinary institution, such as commonly contains a large admixture of low-grade cases, they become discontented, wretched, and resentful, sources of contagious trouble and unrest; and, owing to the limited accommodation, they may be from the outset exceedingly unwelcome there, as excluding cases more urgent and more tractable. For these older borderline delinquents a useful halfway measure, one which would avoid both the danger of unrestricted freedom and the hardship of a life completely isolated and confined, might perhaps be found in the organization of colonies or hostels. The defective would live in the home, but would be allowed out during the daytime for work and recreation. Such hostels should be established always as branches of a parent institution, within which most cases would begin their period of supervision, and back to which all cases that proved unsatisfactory could be instantly recalled.

8. *Guardianship.*—As an alternative to removal to an institution, the Act dealing with the mentally deficient makes provision for placing defective children under suitable guardianship. To find suitable guardians is far from easy; where the child has a bad record, or is difficult to manage, it may be all but impracticable. Nevertheless, the plan is one with undoubted possibilities for the more hopeful cases among the higher grades; and it is to be regretted that so little use is made of the powers conferred for this purpose by the Act.<sup>30</sup>

---

<sup>30</sup> Section 2. The Brighton Guardianship Society, which has to my knowledge handled many cases from London with singular success, might serve in some way as an instructive model. Unfortunately, at

9. *Sterilization.*—The sex instinct in defectives is often violent and unrestrained, and in a feeble-minded male may lead to outrages as brutal as they are repulsive. In cases such as these, Healy<sup>31</sup> goes so far as to urge a drastic surgical operation, not merely to prevent the creature from propagating others of his type, but also to root out these vicious inclinations from the criminal himself. By those who press for a policy of sterilization no stronger argument could be found than that which is put into their hands by the defective criminal whose speciality is sexual assault.

Nevertheless, in the existing state of popular opinion and with the same knowledge that we have both of the inheritance of high-grade mental defect and of the psycho-physiology of the reproductive glands, it would, to my mind, be worse than useless to champion such a policy in England. The most dangerous cases are the borderline cases, and these are always the hardest to diagnose and would be the last for which drastic measures could be enforced. The actual removal of the essential sexual organs is attended with much risk and is followed by unpredictable disturbances of the whole physiological equilibrium; nor is the evidence for an ensuing temperamental improvement as yet at all conclusive.<sup>32</sup> Though preventing procreation, mere sterilization by the simpler operations in common use (vasectomy in the male and salpingectomy—a more serious

---

present, it seems impossible to transfer cases that have learnt some measure of self-control from an institution to guardianship, without employing the most cumbersome machinery. To be so transferred, cases must first be recertified: as it is, however, the difficulty can be partly circumvented by arranging for cases to be sent out from institutions "on leave of absence."

<sup>31</sup> *Op. cit.* p. 462. In the United States sterilization laws have been passed since 1907 in fifteen States. In only two, however—California and Nebraska—is the practice extensively applied. In the former, rather over 2,500 cases, chiefly males, have been operated upon; but, unluckily, of the after-careers of these cases no record seems to have been kept, so that no light has been thrown on the effect of the operation. In nine States the law is either a dead letter or has been declared unconstitutional. In one—New York—it has been definitely repealed.

<sup>32</sup> Healy, however, states that "parents who have had defective boys operated upon in the more thorough way are loud in their praises of its effects upon mind and character."



matter—in the female) would not cure or mitigate abnormal sexual impulses. On the contrary, if from a false sense of security these sterilized high-grade defectives were still left at large, the final outcome might easily be to multiply sexual outrages and to facilitate promiscuous and undetected intercourse.

In the interests of morality, to segregate is as effective as to sterilize and renders the latter unnecessary. For defective youths who appear over-sexed and for those defective girls who, by the very fact of a premature development towards the age of puberty, reveal a physical basis for strong and early sexual impulses, there is but one safe measure; it is the measure I have already urged: they should be immediately isolated from all risks until the habit of control has been firmly established, or at all events until the ability to control has fully emerged. This, again, means either unflinching supervision or else immediate transference to some residential place of safety.<sup>33</sup>

## 2. Dullness

If they are not always definitely defective, most delinquents are yet definitely dull. As we have already noticed, barely one case in five rises above the middle line of average ability; one case in three falls so deeply below it as to be technically classifiable as backward in general intelligence (see Table XV).<sup>34</sup>

---

<sup>33</sup> What I have urged above against the policy of sterilization in the present state of knowledge and the present state of public feeling does not prevent a reopening of the question later, when knowledge and public feeling have advanced. The question has recently been considered by the Council of the Central Association for Mental Welfare and referred by it to its Medical Committee. The Committee and the Council have reported that the policy of sterilization is for the time being impracticable; that, if adopted, it would have only a limited effect; and that it would be followed by unintended but harmful results in various directions. (See pamphlet on *Sterilization and Mental Deficiency*, published by the Association, July, 1923.)

<sup>34</sup> For a fuller account of the dull and backward, I may again refer to my reports on the *Distribution of Educational Abilities* and on *Mental and Scholastic Tests* (esp. pp. 184 *et seq.*). For the non-psychological reader I should here briefly repeat that by technically backward is meant a child who is retarded in mental development by more than 15 per cent and less than 30 per cent of his true age. Thus, a child of 10 who, without being veritably defective (that is, without falling below the level of an average child of 7), is yet beneath the level of an average

Between downright mental deficiency and mere mental backwardness there exists, as is now clearly recognized, no sharp line. The one merges into the other by imperceptible gradations. And except for the few pathological specimens belonging to the well-known clinical types—mongols, cretins, paralytics, and the rest—types that rarely come under notice for transgressing the law, deficiency might be regarded simply as an extreme degree of native dullness—that is, of inborn backwardness in general intelligence. It is, therefore, but natural to find that in the production of delinquency, dullness operates in much the same way, though not indeed with the same intensity, as absolute mental deficiency. Crime, after all, is a simple, senseless way of compassing one's ends; hence, its perpetrators are principally those who, in the literal meaning of the phrase, are born simpletons: most rogues are also fools. Indeed, it is a commonplace among detective officers that nearly every criminal, however adept he may become in his own selected line of knavery, can nevertheless be relied upon, almost without fail, to execute some minor piece of folly, to leave some clue behind, to neglect some obvious precaution, and so, with his own hands, to open up the way for easy discovery and ultimate arrest.

Whether he is still at school or whether he has quitted school for industrial life, the history of the dull delinquent pursues pretty much the same general course. At lessons he drifts to the bottom of his class; and, under old-fashioned methods of teaching, becomes quickly branded as the dunce and the nuisance of his school. School itself not only loses any interest it might conceivably have had for him, but comes rapidly to seem

---

child of  $8\frac{1}{2}$  is termed "backward" in this special sense. If the backwardness is an inborn backwardness of general intelligence, such as is measured by the usual psychological tests, it is convenient to speak of the child as "*mentally* backward" or "*dull*": if it is a backwardness in acquired scholastic attainments only, the child may be termed "*educationally* backward" or (where the context leaves no ambiguity) "*backward*" simply—using the term now with a more restricted meaning. It should be noted that after the age of 16 the category of the dull includes many who were certifiable as defective during childhood and ceased to be so certifiable on leaving school, owing to the somewhat lower line of demarcation adopted in certifying adults.

just a useless place of torment, a place where he is hourly scolded or punished, a place where he learns little except that he himself is good for nothing, a place, in short, which it would be better to avoid. He soon begins to live up to the character he is given; and, to escape the drudgery of work for which he has neither aptitude nor inclination, falls readily into the ways of an habitual truant.

When, two or three years after their schooldays have finished, these dull delinquents are brought back to me for some petty offense, their ignorance is amazing. It is difficult to believe that they have had ten years' teaching in writing and arithmetic. For them, however, to forget is always easier than to acquire. What is exposed in a shallow basin soon evaporates, and the little sediment of learning, no longer replenished from day to day, dries quickly up in an unretentive mind.

In later life, the effect of maladjustment is similar to that observable at school. From his lack of common knowledge and intelligence it is hard for the dull youth to find remunerative work, harder still for him to keep it, and all but impossible for him to perform the requisite duties so as to avoid the reprimands of the foreman and the contempt of his fellow laborers. Once more, therefore, he begins to make up by illegitimate means—by shirking, by deceiving, by lying, and at last by stealing—for what he has lost through want of general competence.

Unlike the weak-minded, the dull are not so dull as never to feel their own innate shortcomings. Often, indeed, they are keenly aware of it; and the dim, half-realized sense of their born inferiority, an inferiority which they cannot help, but for which they are incessantly blamed, may act as a rankling grudge against the world in general, or against their luckier relatives and schoolmates.

### *Types and Illustrative Cases*

As with the defective, so with the dull, it is convenient to distinguish one or two subordinate types. If in temperament he is neither aggressive nor emotional, the unintelligent child grows sullen, listless, and disheartened, dull in disposition as well as

dull in understanding; and so seems more stupid and more backward than in truth he is. If, on the contrary, he is by nature self-assertive and impulsive, if his emotions are as active as his reason is inert, then he will refuse to be downtrodden; the humiliating thought that he is and must be a born underling, he will never meekly bow to; more likely, he will with vehemence react against it, finding or creating situations where, in one way or another, he may show himself not inferior but superior alike to his companions and to those under whose authority he is placed.

One illustrative instance I may offer for each of these opposite types, taking the second and more difficult first.

1. *The Aggressive*.—Cases of this latter kind are not infrequent among the backward offspring of the better classes. Vivian L. is a typical example.<sup>35</sup> He was a lean, lank, lively-looking boy of fourteen, the second son of a medical practitioner. His general appearance was not conspicuously suggestive of either foolishness or guile. Sprucely dressed and scrupulously clean, he had a ready smile and pleasing features; but his eyes—vacant, restless eyes that never looked one straight in the face—were sufficient to betray him.

---

<sup>35</sup> *Age*: 14½. *Home Circumstances*: Parents cultured and well-to-do. Discipline and management were above criticism, except for a slight emotional element occasionally introduced by the mother; she is thought somewhat too partial to her eldest son.

*Family History*: Father's family mainly professional people. Mother slightly emotional and neurotic; mother's family literary or artistic, with tubercular tendencies. One brother, aged 16, exceptionally intelligent, but feared to be tubercular. No other defects relevant to the case.

*Physical History and Condition*: Mother worried during pregnancy; labor difficult. Walked at 13 months. Talked at 15 months (6 months later than elder brother). Measles, diphtheria. Adenoids and tonsils excised. Slight bronchial catarrh when examined; health otherwise normal. Height, 159 cm.; weight, 38.4 kg.

*Intelligence and School Attainments*: Mental age (Binet tests): 11.2; (performance tests): 11.5; (average mental ratio, 80). Reading, 10.0. Spelling, 9.0. Composition, 9.5. Arithmetic, 11.0. Handwriting, 10.0. Drawing, 12.0. Handwork, 11.5. Marked defect of mechanical memory, visual and auditory. No undue tendencies to verbalism or imagination shown by tests.

*Temperament*: Somewhat unstable and aggressive. Unrepressed rather than repressed.

He had been boarded at a well-known preparatory school in the North, which happened, from its unusual situation, to be recruited mainly from the clever sons of clever men, boys whose fathers were lecturers\* or professors at the neighboring University. Here it was at length concluded that he must be mentally deficient. Relatively to his own social sphere, he was. His mental age was a little over eleven; yet, with this mentality, he was as much below the intellectual standard of the bright youths of his school, as the special school child is below the average pupil in a school of the ordinary elementary class: he was as much out of place in his form as a genuine defective sitting in Standard VII. The natural reaction followed. By bragging or bravado, Vivian insidiously contrived to gain a malign ascendancy over a small set of juniors in his house. He would draw them round him as spectators of his rebellious feats and as auditors of his far-fetched tales, so that they might see what a bold fellow he was, hear what a noble family he was sprung from, and learn what obscene and hidden mysteries he could unveil. All his imaginative zeal, which should have been fixed upon his lessons, went to concoct or to decorate his riotous exploits. At first his recitals were almost pure inventions: little of what he boasted had actually been performed. But, unhappily, though his master advised his removal, his parents begged for him to be retained. And now he put his fancies into action, seeking to rehabilitate himself, in his own eyes as in those of others, by wild bursts of disobedience and audacity, aimed as acts of subtle defiance against those who sought to shame him. He took to various corrupt practices on a limited scale—a good deal of private bullying, an increasing amount of open mutiny, and presently a succession of daring thefts. For long a disregard for truth helped him in and out of his adventures. Of the smaller boys who were his accessories or dupes, not one dared breathe a word against him. At last, he ran away with a hired bicycle, spent three days at a seaside resort without paying his bills, and then, hungry, scared, and penniless, cycled the remaining thirty miles to his home. A psychological examination made it clear that he was by no means certifiably defective, and led, in the course



of analysis, to a confession both of his secret grievances and of his strange mode of brazening himself inwardly against them. Transferred in the end to a private school for backward youths, he astonished all who knew his past by making a complete recovery and has since achieved an excellent record at sea.

2. *The Apathetic*.—From the long list of dull offenders docketed in my files, I select one more which exemplifies the quieter and commoner type.

A boy named Jim, of coster descent, was brought to me from a slum at the back of Euston Station.<sup>36</sup> He was a loose-limbed,

---

<sup>36</sup> *Age*: 15½. *Home Circumstances*: Father, a carman working for the railway, earning 26s. a week (in 1916): plausible, talkative, but of a somewhat dull intelligence. Mother, stout, slatternly, and slow, of moderate intelligence only; thriftless and over-indulgent. The family had moved from district to district; and once lived in a tenement building occupied by vicious characters. Their ultimate home consisted of four rooms for a family of seven, rent 6s. 6d. The parlor, as I saw it, was a vivid witness to the habits of the family: it was packed with rickety mahogany furniture that told of wealthier grandparents; the window panes were broken and the curtains thick with the dirt of weeks; the walls were hung with photographic memorials of innumerable bank holidays and bridal parties; on the table lay the mingled remnants of breakfast, dinner, and tea; and the whole was lit by a guttering candle end stuck in an empty beer bottle. The tone and discipline of the whole household seemed lax, but not openly corrupt. The maternal grandmother declared that she urged Jim's parents to marry "before all those children were born," and "doubts if they are married now."

*Family History*: The father's family are all laboring people, of poor intelligence and of an unstable type. The parental grandfather, formerly a hawker, is of the same specious and loquacious disposition as the father, and arranges "Sunday concerts" at his lodgings where all the family meet and sing. The mother is said to have come of an intelligent and prosperous coster family and to be of gipsy descent. Four other children, Jim being the second. All are below average intelligence, but none so dull and backward as he. Eldest brother, a delivery boy (20s. per week); said to be steady. Alcoholism in several members of the family on either side. Paternal cousin feeble-minded.

*Physical History and Condition*: Walked and talked at 18 months. Measles, chickenpox, diphtheria. Pale, unhealthy-looking (see text). Adenoid growths, and thickened nasal septum. Treated for nasal discharge at 11½. Vision 6/9 (R and L). Tremor of outstretched hands; occasional dyspepsia attributable to excessive smoking (20 cigarettes a day). Puberty somewhat early (at 13½). Height, 158 cm.; weight, 52.5 kg.

thick-lipped fellow of fifteen and a half, with a big slouching figure, tremulous hands, and telltale stains of brown upon his second finger. Apart from slight signs of nasal obstruction and a tired and puffy look (for which late hours, irregular meals, and ceaseless cigarettes were largely to blame), his general health was fair. He appeared, by his general manner, to be a lad not innately vicious, but foolish, flaccid, self-indulgent, and easily led astray. The art of life was for him some clever trick or puzzle, the key to which he could never quite grasp. At times feebly emotional, he was ordinarily inert and listless. His want of energy and of moral strength, his crude and cowl-like intellect, his coarse but not ill-natured instincts, seemed plainly legible upon his face. There was no need for testing to demonstrate that he was dull, but only that he was not definitely defective. He had a mental age of eleven and a half, but his reading and spelling were those of a child of ten and his arithmetic that of a child of eight. His low attainments are plainly seen from the specimens of his spelling and writing reproduced below.<sup>37</sup>

At school he had played truant and had occasionally pilfered. On leaving, he failed to find permanent work. In two years

---

*Intelligence and School Attainments:* Mental age (Binet tests): 11.0; (Performance tests): 12.0; (average mental ratio, 74, or taking 14.0 as denominator, 82). Reading, 10.2. Spelling, 9.8. Composition, 9.0. Arithmetic, 8.2. Handwriting, 8.0. Drawing, 9.0. Handwork, 10.5. General knowledge, 10.0. In tests of memory and power to report, extremely confused and suggestible.

*Temperament:* Unstable and impulsive; generally repressed, but occasional outbreaks of emotionalism. Physically he resembles his mother's family; mentally he resembles his father's, but is less garrulous and outwardly seems more phlegmatic. Instability aggravated by adolescence: slight hysterical tendencies.

*Employment:* Delivery boy at W.'s, F.'s (dismissed), and R.'s; engine-cleaner's boy for N.W.R.; delivery boy for M.R. (paid by tonnage and earning sometimes 30s. per week; dismissed); now meat porter at Smithfield market (16s. per week).

*Delinquencies:* Frequent truancy from school: "during best year missed 30 sessions; mother always full of excuses." Occasional petty theft at home; used to pilfer fruit from stalls with other boys from tenement buildings; but was never charged. Ran away from home to live with aunt because he feared a thrashing when dismissed from M.R. Attempted a sexual assault on cousin aged 10½.

<sup>37</sup> See page 315, and Figure 16.

he had had six jobs—chiefly as a delivery boy for various firms. From one he was dismissed for swearing at the inspectress; from another, for leaving a cart unattended. He could not tell the time or read the numbers on the street doors when the numerals were higher than nineteen. Thus, for all but the humblest callings he was hopelessly unfit.

He came to me charged with a sexual misdemeanor of a peculiarly senseless kind. After examination, he was recommended for a farm colony for juvenile delinquents, where the discipline was entirely free. His after-history was most instructive.

During the first week in the country he was happy and self-complacent. His health improved; his color returned; his fatuous smile began to disappear. His instinctive interests, however, still survived. To the superintendent one of his first inquiries was: "Will there be more girls coming down—so as we can have one each?" The two girls already in the colony flouted his advances from the start, and he began to take up with a pair of boorish dairy maids from a village<sup>38</sup> three miles away. The little tribe was self-governing and jealously self-contained; and there ensued a clamorous uproar against the breach of dignity that this threatened exogamy implied. The superintendent, so far from forbidding Jim's philanderings, encouraged him to invite his alien Venuses one Saturday afternoon to tea. I happened to be spending a few days there at the time. The visitors were painfully self-conscious and constrained; their mode of dress, their style of coiffure, their manners at the table, were the scorn and scandal of all the young aristocrats from Hoxton. Polly, the hostess of the gathering—a girl with the reputation of a phrase coiner, though her father coined something more material—tartly declared that the newcomers were "rag dolls stuffed with sawdust." And, indeed, compared with a lively minx from London, they were. Jim was mortified. The next evening found him in a glum and crumpled state, wetting his stump of pencil as moist

---

<sup>38</sup> I have been compelled, in the interests of those concerned, to make one or two inessential changes in editing for publication my notes of this short history.

as he could make it and writing in emphatic blacklead this message to his mother: it was the only letter of his that ever reached her, and reveals very plainly what a simple-minded animal he was.

dear mother

just a few lnes to let you know that I am very unhapy just at persent last night I when with another girl insted of going with my one she came down sturdary in some cloths and she look just like marrid wooman that it why I did not go with her she must get cloths before I go out with her I think it beest to stop away from the town girls altotter I havend been in any troble ever sinch I came cores they are all very happy so was I til sturdary think it best to stop atome and go withe the other

from your  
loveng  
son  
jim

After their rebuff his rustic acquaintances declined to have any more to do with him or with his colonial friends. Three days later a different instinct came uppermost, and he resolved to end his grief and heartache by swallowing ink and kerosene. True to the traditions of all disconsolate lovers, the would-be suicide left a letter behind him to explain his fate.<sup>39</sup> He was suffered to consume as much oil and ink as he desired; and the superintendent and myself sat up all night watching his irresolute attempts to drown himself in the stream that ran hard by. We knew, of course, that the first touch of cold water would awake yet another instinct—fear and self-preservation; and so it proved.

This was the crisis, the turning-point in Jim's career. Like a somewhat unintelligent dog, he learnt from these bitter experiences far more than he ever had done from hours of pious expostulation or of drastic punishment at the hands of teacher and parent. After moping sulkily for a day, he betook himself to digging alone in the garden. He was the first of his group, in fact, to turn of his own will to any form of useful work.

---

<sup>39</sup> See Figure 16.

At length, after a few negligible lapses, he was sent back to London, and now has the best after-record of any of his set. He was found an engagement as a porter on the railway, and here his very stupidity helped him to distinguish himself in a truly heroic style. He chanced one day to be on duty when the station hotel was bombed from a German airplane. Too dense to realize the danger of what he was doing, he kept his senses when porters less obtuse and more imaginative lost their heads. His good nature (for he had tender emotions as well as sordid) enabled him to be of signal service to many of the wounded, and, as he afterwards told us, he could not see why any one should mind "cleaning up the blood and bits upon the pavement." He was appropriately rewarded, and this recovery of self-respect steadied him so much that (to quote the pardonable hyperbole of one of his friends) "he is now one of the proudest and most willing porters on the line."<sup>40</sup>

### *Treatment*

1. Special Classes for Dull and Backward Children.—In dealing with this group at the younger stages, the most important broad administrative measure is the organization of auxiliary classes, perhaps even of intermediate schools, specifically for the dull. Here the young dullard would receive something of that extra supervision accorded in the special school to the mentally defective; the curriculum would be so framed as to relieve him of the burden of scholastic exercises that are utterly beyond his powers and at the same time to give him work of a concrete, manual, and practical kind, such as might arouse his interest and use up his energy, and equip him for the tasks of after-school life.

The measure would be preventive as well as remedial. By far the greater portion of our potential criminals would be caught in the meshes of the special class. And it would thus become possible to cope with almost the whole problem from

---

<sup>40</sup> Since the above was written I have heard with regret that, in the general cutting down of staff, the lad whom this history chooses to disguise as "Jim" has been once more thrown out of work, and has become not indeed a criminal, but a sour and discontented loafer.



SYSONBY HOUSE,  
RIVERSIDE VILLAGE,  
MELTON MOWBRAY.

I can mother  
and father  
I am gargly  
doying myself  
in over the trouble  
of ~~boys~~ and girls

FIG. 16. FACSIMILE OF LETTER BY "JIM"

"Dear mother and father I am gradually doing myself in over the trouble of girls." There is no signature. "Gradually" is spelt phonetically, and in correspondence with the boy's pronunciation.



the very earliest beginnings—to study individual cases, to strengthen the weak intellect, and to fortify the infirm will, before the habits of delinquency became thoroughly ingrained, and often before any criminal temptation was encountered or experienced. Much, indeed, in this direction has been accomplished already. And those who visit the backward classes now in existence are astonished to witness the result, to observe how the dull brain is brightened and the unstable temperament steadied, to note what a stimulating reaction upon character may be produced by furnishing suitable school work and suitable intellectual interests adjusted to the low level of each individual child. Provided the transference to a special class entails no brand or stigma, the children committed thither, finding that there is after all a species of work at which they can shine, begin not to lose but to gain in self-esteem.<sup>41</sup>

2. Segregation.—What, however, is to be done with the dull delinquent when he has passed the age of leaving school? Of all the problems of juvenile delinquency one of the most pressing is that of the subnormal adolescent. Most of them, though not mentally defective, are but little above the borderline, and would, indeed, be termed feeble-minded, or “morons,” had the somewhat sweeping definition of the American Psychological Association been practically acceptable. Not a few of them have actually been certified during school years under the Education (Defective and Epileptic) Act, but after sixteen, under the Mental Deficiency Act as at present interpreted, seem certifiable no longer. Accordingly, many a social worker would be disposed to stretch some clause in the statute book and to have these milder cases certified and permanently segregated, together with the admittedly feeble-minded or imbecile. Certainly, it is a mark of the congenitally backward that, both during school life and afterwards, they can never “compete on equal terms with their fellows,” and this inequality in social competition was at one time put forward as the distin-

---

<sup>41</sup> For the mode of organization of backward classes, I may be permitted to refer to my pamphlet on *Backward Children*, published by the London County Council as Development Memorandum No. 1 (P. S. King & Son, 1918, price 2d.).

guishing characteristic of the defective. Were we, however, on this one ground to regard all who are dull and incompetent as mentally deficient, we should soon find that nearly one-tenth of the population had to be treated, in theory at any rate, as in need of public care and control. Ten per cent of the population are technically backward. But these 10 per cent are not all criminals. Most of them, indeed, are too dull to be dangerous.

It may assuredly be conceded that as public opinion advances and as more liberal funds are granted for such a purpose, it will become practicable to raise, step by step, the limit of demarcation for the certifiable and to segregate the more seriously backward, at any rate when their backwardness is coupled with a fixed proclivity to crime. But to any wide extension of this simple measure, threatening, as it would, so deep an encroachment on the liberty of so large a section of the population, there are obvious drawbacks, social as well as psychological. Manifestly, one fatal consequence might be to herd together in close association dull criminals of totally different types, regardless of the real origin of their criminality. To give this measure a pseudo-psychological color by talking, not of the fact of crime, but of a propensity to crime, is simply to obscure the fundamental axiom that propensities to crime are of a very different nature in different individuals and that something approaching a propensity to crime belongs, in one shape or another, to every man of us. As with the deficient, so with the dull, the feebleness of mind is usually a negative or at most an aggravating factor in his violations of the law; the precipitating cause, whether residing in the individual or in his environment, whether hereditary or acquired, calls for fuller psychological investigation before it can be fairly treated either by segregation or otherwise.

3. *Guardianship.*—Many of these difficulties could be surmounted by extending the principle of guardianship to cover the case of the dull delinquent, particularly where the home falls short. Such a person, as experience shows, when placed in the sole care of a firm and sympathetic guardian, may give but little trouble and, after two or three years have passed, may recover his stability. The guardianship need be no formal

committal; it might be simply made the condition of temporary discharge from the court. By this means, the child would be rescued from the bad influences of his neighborhood; he would be isolated from other dullards and delinquents, by whom he might be harmfully swayed or whom he himself might still further demoralize; and he would receive in place of a parent too dull to love or to control him intelligently a substitute for a parent who would do both.

4. *Hostels*.—An intermediate course would be to establish residential homes or hostels of the type already described for high-grade defectives. Here even greater freedom and initiative could be permitted to the mentally backward than would be safe for the mentally deficient. Here the inmates would receive a comfortable home, suitable companionship, and the needful supervision; but at the same time they could be accorded a liberty and an independence that could hardly be allowed in the existing type of institution. Under such a régime an adjustable amount of guidance could be given, and an adjustable amount of control could be exercised, in regard to both money matters and spare time; the young person would be free to go to and fro for daily work, and even, within certain limits, to turn where he liked for recreation and amusement, when the business of the day was over. The hostels might be placed in neighborhoods where there is a demand for labor of a simple routine type—domestic service, laundry work, and work on farms, in fields, or at a factory. The teaching methods of the special school could be adapted to train the inmates in unskilled repetition work, such as a low intelligence can usually learn; and would carry forward the efforts begun in the backward class, just as institutions for the defective continue the work of the special school. A gentle constraint would be used to prevent such persons from flinging up their jobs, squandering their money, or blundering into mischief during leisure hours. A solution of this kind seems particularly commendable for the dull and backward girl during that critical epoch in her life that reaches from the dawn of puberty to the close of adolescence.

5. *Industrial Schools*.—Boys of dense, but not defective intellect often do well at an industrial school; character usually



improves, if intelligence does not. Fuller opportunities, however, are wanted both for suitable training while there and for suitable employment later on. Dull girls, if one may judge by their after-histories, are less influenced by such methods, and, broadly speaking, for girls of whatever type, intelligent or not, institution life is never so desirable. To the girl, home life, home ties, and home affections are essential. For her the cottage system, as adopted, for example, by the Barnado Homes at Barkingside and the Princess Mary Village Homes at Addlestone, provides a domestic experience and a domestic atmosphere far better suited to the needs of her nature.

6. *Choice of Employment and Suitable Vocational Training (Semi-Skilled Labor)*.—Recent work in vocational psychology has led to a grading of occupations according to the degree of intelligence they severally require. The callings suited to the dull and less intelligent are obvious. Many of the boys choose, and choose rightly, either to work upon the land or else to go to sea. Yet, during the three years covered by the Home Office Reports, 1921 to 1923, of the 8,490 boys who left the certified schools only 13 per cent became farmhands, less than 6 per cent joined the army, and barely 6 per cent the navy or mercantile marine.<sup>42</sup> The nautical schools, though distant from London, are good, and the farm schools, though compelled by want of general coördination to employ many of their inmates within the workshops, have often excellent facilities for agricultural instruction. Many a London lad who hates the city life and falls into trouble on the streets would make a first-class rural laborer; yet again and again such youths are sent off to small and overcrowded premises in the middle of some populous town.

The dull girl, provided she owes her delinquency less to her unstable temperament than to bad company or bad surroundings at home, often turns out well when prepared for domestic service: everything, however, must depend upon the tact, sympathy, and supervision bestowed upon her by the mistress to whose care she is committed. The chief alternatives are factory

---

<sup>42</sup> *Home Office Report, loc. cit.* (1924), Table VI, p. 78.

work or laundry work—the latter a trade increasingly common for delinquent girls. More, indeed, might perhaps be done in sending these young girls to suitable work upon the land either at home or abroad. But, unless she shows some special and exceptional aptitude, to train the dull girl for a skilled employment is worse than a waste of time: it increases her sense of failure and leads others to accuse her of laziness or carelessness when the real fault is sheer incompetence. Of those who leave the certified schools as many as 64 per cent become general servants, and a small but appreciable proportion become nursemaids. Yet a large institution is no ideal place in which to train the future maid or nurse of a small suburban villa, and those girls seem to do best who have been sent to some smaller home where they have had greater freedom, a fuller life in the open, the liberty to dress as they will and to earn, spend, or save a little pocket money of their own, and—the most mollifying influence of all—an opportunity for tending the needs of tinier children. It need hardly be added that, in view of the dangers and drawbacks that attend the life of a young girl sent out alone into domestic service, far greater care is requisite in choosing a suitable situation for her than might be necessary in the case of a boy.

### 3. Educational Backwardness

So far I have been discussing primary or inborn backwardness—that is, an inherent backwardness in natural ability due to slow development. I now turn to consider what may be called secondary backwardness—that is, an accidental backwardness merely in acquired educational attainments, or, in one word, ignorance.

Nothing is so startling about the juvenile delinquent as his extraordinary lack of knowledge: it is, with him and with his kind, more frequent and more profound than any other intellectual failing. He is ignorant alike in the narrower respect of the simpler scholastic subjects—reading, writing, and arithmetic—and in all the wider spheres of ordinary information and culture.

Of my delinquent cases, nine out of every ten fall below the

middle line of average educational attainment, and three out of every five are so far below it as to be classified as technically "backward" in school work.<sup>43</sup> Among these, over 20 per cent of the whole number appear so utterly unable to read, spell, or calculate as to be classifiable as "educationally defective";<sup>44</sup> they appear, that is to say, as unlearned and illiterate as a child from the special school. Thus, the majority of criminal children, though not to be branded as defective or subnormal, are nevertheless indubitably backward. The educational ratio of the average juvenile delinquent is only 81 per cent. This means that at the age of ten his attainments are those of a child of eight, equivalent to a meager Standard [Grade] II. At every stage he is far more behind in knowledge than in capacity, and tends all through his school career to be a year or more beneath even the low standard of scholastic work to which, with his intelligence, he should at least attain. Of those who are old enough to have left school already, more than half are under the level of Standard V.

The figures cited, it should be remarked, include the numbers for the previous categories, namely, the mentally deficient and the mentally dull, but the several pairs do not altogether coin-

---

<sup>43</sup> See Tables XV and XVI, pages 282 and 287. By "technical backwardness," the reader will recollect, is meant a retardation to the extent of more than 15 per cent but less than 30 per cent of the chronological age.

In the whole of London the proportion of backward children may be taken as roughly 10 per cent (see *Distribution of Educational Abilities*, L.C.C. Report, No. 1868, 1917, p. 36). The higher proportion found among the non-delinquent children in the present inquiry is owing to the fact that these children, being selected from the same schools and social classes as the delinquents, form an inferior sample in point of culture and attainments.

I should add that the figures for backwardness given in the present work differ slightly from those given in my earlier paper (*Brit. Journ. Med. Psychol.*, *loc. cit.*, p. 25). In calculating the educational ratios for the earlier paper I included tests for handwriting, drawing, and manual work wherever these were applied. Here I have thought it better to exclude all but the definitely scholastic tests, reading, spelling, composition, and arithmetic.

<sup>44</sup> By "defective" is meant, as before, retarded by 30 per cent or more of the chronological age—not now, however, in inborn ability, but in educational attainments.

cide. Congenital defect and congenital backwardness produce almost invariably a defect or backwardness in scholastic acquirements, but defect or backwardness in scholastic acquirements may result from other causes than sheer native incapacity. The dull are nearly always retarded, but the retarded are not necessarily dull.

Of those whose educational backwardness is merely secondary, there are many subordinate types, each of which must be dealt with according to its own particular cause. With many the backwardness is due in a large measure to physical causes—disease, delicate health, and the usual list of bodily ailments that delay the progress of the normal child at school. With others it may be traced to some limited disability psychological in its nature—some temperamental failing or some defect of memory, reasoning, or attention. But most commonly in the delinquent the backwardness has a moral source. In class he is recognized as the lazy child, the disobedient child, the unruly child. Often, like the inborn dullard, an habitual loafer and truant, he will still try to shirk his lessons even when sitting in the school-room, and then, as a rule, feels tempted to hide his shortcomings—with greater craft than his dull colleague—by cheating, copying, and all the tricks of the underhand scamp. One form of dishonesty begets another, and it is no long stride from stealing your neighbor's ideas to stealing your neighbor's purse.

The delinquent, however, is not only a dunce in the special subjects of the school. He shows also, as a rule, the most scanty acquaintance with all common topics of useful information. It is an instructive experiment to draw up a testing scale for general knowledge, arranging the questions according to the successive ages at which, as a rule, they can be answered. Measured by such a scale, the criminal appears a woeful ignoramus. To matters of a thoughtful cast—the popular items of applied science or motor engineering, the elements of local and political government, the sights and institutions of the city in which he dwells—things of which the average schoolboy gets at least some smattering—to all these he is a total stranger. Nor do his leisure interests take any more practical turn. Most

lads of the same years and of the same mental level will have some hobby—collecting postmarks, studying locomotives, making toy kites or wireless sets. He has none. If he reads, it is a picture paper, a colored comic, or the adventures of “Deadshot Dick and the Avenging Nine.” If he goes to any place of amusement, it is to an amusement park or a cinema, from which he culls surprisingly little that is of any intellectual worth. No games can he play that call for skill, judgment, or organized coöperation: and, by the side of the normal youth of his own school or neighborhood, his athletic accomplishments are singularly meager. Thus his mind is utterly vacant: he has no progressive interests, no cultivated pursuits, and, with nothing to engage his wits in his spare moments, it is small wonder that in the hunt for stimulus and relaxation, he lights only upon enterprises that are held in a civilized community for vices or crimes.

Once more the best method of describing the general type is to give the record of a concrete case. Robert N. had been charged as an incorrigible thief and was sent to me on the ground of alleged mental defect.<sup>45</sup> He was a typical street-

---

<sup>45</sup> *Age:* 13½. *Home Circumstances:* An only child. Father, plumber (35s. per week: pre-war). Mother, occasional charing (about 5s. per week). Three rooms (rent, 7s. 6d.) in a respectable tenement building. Father intelligent, but somewhat strict and aloof; mother a little gouty, somewhat dull, but anxious and well-meaning; both often absent from home till evening.

*Family History:* So far as is known, all members of the family on both sides are members of the artisan class, moderately intelligent and highly respectable. Maternal grandfather, a foreman in an engineering firm; but, according to the mother, “like Robert, never a scholar,” and barely able to write. Gout in mother’s family. No other noteworthy defects.

*Physical History and Condition:* Measles at 5½, followed by “bronchitis” (perhaps broncho-pneumonia). Three carious teeth; swollen submaxillary gland; “winter cough.” Height, 142 cm.; weight, 31.3 kg.

*Intelligence and School Attainments:* Mental age (Binet tests): 13.5; (Performance tests): 14.0 + (average mental ratio 102 +). Reading, 7.4. Spelling, 7.0. Arithmetic, 8.0. Handwriting, 11.5. Drawing, 12.5. Handwork, 14.0. Singing well, and has a good ear for pitch and rhythm. Memory, good; visual imagery, unusually good; marked manual and mechanical aptitudes.

*Temperament:* Active, assertive, and adventurous; but not unusually unstable for a young boy on the threshold of puberty: talkative, and a



Arab of thirteen and a half, alive to the finger-tips. His clothes were in tatters; his face and hands were cleaned only on the portions more exposed; one polished cheek had a bar sinister of smut and smudge across it; and a brown wisp of disheveled hair trailed over one eye. His gaze was not shifty, but observant and alert; his eyes seemed always to be watching me whenever he thought mine were not watching him.

Half an hour's psychological testing proved what the first glance had indicated—that he was quite equal to the average in every natural faculty. His mental age was nearly fourteen. On the other hand, when I turned to my educational tests, I found that he could barely read the words from a Standard I reader; and, since so much of the work in a senior department hinges on a capacity to read and to spell, Robert had always lagged behind in arithmetic, English, history, geography, and, indeed, in every subject of his class.

His disability in reading came from a purely accidental cause. At the age of five and a half he had been attacked by measles. The illness was severe; and, owing to his slow recovery, he had not returned to the infants' school until he was old enough to be promoted. Just at the critical period when the ordinary child is taught the rudiments of reading, he had thus been absent; and since it is the recognized business of no one in a senior school to impart these beggarly elements, he had been left to idle in a corner until it was supposed that he must be mentally deficient. Had he only been relegated to the infants' department for an extra year, or received additional attention to make up for the time he had lost, a long succession of crimes would probably have been saved.

Robert's home was a little better than his person might have conveyed. His parents were sober, hard-working people, both of them away from their lodgings during the greater portion of

---

little vain; discusses himself in a detached manner and in grown-up terms.

At the age of eight he had caused much anxiety by running away and singing for pennies in the streets. By the advice of the local clergyman, he was later placed in the church choir, and was paid in money for his help at home. It was now, at the age of ten, that he started his career of secret and successful thieving. Robert's explanation was that "begging's

the day. An only child, he had no one indoors to play with; he was unable to amuse himself with a book, and possessed no toys, no building blocks, no outfits of Meccano to occupy his hands. His father was a plumber, and though the boy was expressly forbidden to touch his father's chest of tools, he furtively borrowed the more interesting appliances when no one was about, thus, in his efforts at self-instruction, committing his earliest essay in theft. Now pincers are useless unless you have something to pinch, and a wrench is poor fun unless you have something to prise open. To try plumbing the gas pipes seemed dangerous, but the meter looked rich in possibilities. And by means of the wrench, the pincers, and a strip of stiff wire, together with a little ingenuity and an abundance of time to himself, it was no difficult matter to get the shillings out and count them, and having counted them, to keep them.

Unfortunately, the enterprise, but not the method, was discovered, and, in future, Robert was locked out in the road while his parents were at work. In the alleys near at hand, as in the playground of his school, he kept with the duller or younger children from his own low class, and soon rose to be the leader and the hero of a band of mischief-seeking scoundrels who followed at his tail. After one or two trials and with a little deft manipulation, the dodge that served for opening the gas meter proved useful in forcing chocolates and cigarettes from slot machines on railway platforms. Then one day they all thought they would be happier with a football. Between them they could muster no more than a dishonestly accumulated half-crown. That evening there came to Robert's mind the thought of a certain locked drawer; the keys were accessible, but the drawer was not, for his mother was in the kitchen. So he took the bunch into the yard, and, by filing down one which would never be missed, made a duplicate for the drawer in which his father kept his cash. But, when his parents were out, the kitchen also was locked; so there was a further delay of a week while he tried other keys from other tenants' kitchens till he chanced upon one that fitted his own. At last, on a

---

not much cop when you're big": apparently, passersby take less notice, and the police take more.

Friday evening after his return from school, he picked first one lock, then the other, and discovered far more money than he wanted, nearly four pounds in all. But now came a hitch. The skeleton key which had unlocked the kitchen door refused to lock it up again, and for a moment he trembled on the brink of sure discovery. Presently reflection suggested a ruse: he quickly pulled out all the drawers, turned the kitchen and the parlor upside down, and, when his parents got home again, Robert was found gagged, blindfolded, and trussed up in a chair, uttering muffled yells for rescue from imaginary burglars.

During the next six months the same mysterious cracksmen broke into nearly every flat in the building. The inhabitants had been wary enough to hide their money but not their watches and jewelry. Robert's usual tactics were first to take a pilfered ring or brooch to a pawnshop a mile or two away and there to pledge it; then while the shopkeeper was writing out the ticket, he would manage to abstract an article of greater value; with this he would journey to some suburb in the south of London and pawn his second acquisition. Should a too-suspicious pawnbroker inquire, "How is it that your mother is sending you with such an expensive ring as this?" he would whimper, "Mother's drunk again: she wants it for the beer." Thus provided, he would set out, like Whittington, on a voyage of discovery beyond the outskirts of London, in trams, in buses, and sometimes even in taxicabs, one day visiting the docks in the East End, on another the restaurants in the West, later still going further afield, and finally, in his last excursion, proceeding as far as Southend. Here at daybreak he was found by the police—curled up asleep in a bathing machine.

The intelligent criminal is usually a vain fellow; and Robert was so vastly proud of his exploits that it was easy to steer him into an autobiographical mood and so gradually to extract his whole story. About the boy himself there was something far superior to the life that he was leading; and, in spite of the long tale of grave offenses, I found it feasible to get him dealt with leniently.

Two things were done. First of all, he was removed to another school where there was a special class for backward

children with plenty of manual and mechanical work: some one gave him a copy of *Sexton Blake* and he rapidly learnt to read it, advancing to *Sherlock Holmes* and other works of Sir Arthur Conan Doyle at a later stage. Secondly, a young university graduate to whose interest he was recommended developed a special liking for the young Bohemian, took him for journeys exploring London, and later for jaunts to the country and the sea. In less than two years—that is to say, by the time he was ready to leave school and take up a career—he was a perfectly normal, law-abiding citizen, still a little backward in reading, but an eager enthusiast for life, full of facts and information and assiduously apprenticing himself to a simple branch of an engineering trade.

### *Treatment*

These cases of mere educational backwardness are among the most hopeful that one can have to deal with. Since the child's native intelligence is but little, if at all, below the average, there is every chance that, as he grows up, he may perceive the hopeless folly of a life of crime and settle down in the industrial world to a post of respectable labor.

1. Examination.—When he comes under official notice, the first thing to do with such a youth is to examine him, keeping two crucial points in view: the one, to discover if the child after all is merely backward and not also innately dull; and the other, assuming his inborn ability is normal, to find out what has caused his backwardness and how the obstacle may best be removed.

No error is more treacherous than the almost universal inference that because a boy is backward in school therefore he is equally dull outside it. Teachers, parents, court officials continually drop into this natural mistake: too often the boy himself finds it a convenience to trade upon the character thus given him, and here, more than anywhere else, the psychologist with his exact mental measurements can tender useful aid. How to treat such backwardness, once it is proved to be an artificial not a natural state, will usually be obvious when the cause is known. Physical defects and ill health may be remedied by

medical treatment on lines indicated in the previous chapter. Truancy and irregularity may be cured with the help of the attendance officer. Other causal factors can similarly be attacked by ways suggested by simple common sense.

2. *Special Intellectual Defects.*—One causal factor of particular importance—and a point that is often overlooked—is the existence of some specialized defect. Express attention should accordingly be paid to those who suffer solely from some limited form of backwardness, who are retarded in one subject alone. Robert's history, though not quite typical of this group, is yet suggestive: his backwardness in reading was due to an accidental circumstance and yet impaired his whole school life. In the more serious instances, such limited forms of backwardness may spring from some inherent defect of the mind, not general but localized—a poor memory, a feeble attention, a specific inability to deal with words or other abstract symbols. A number of my cases include small boys of eight or nine, normal in general intelligence, quick at simple arithmetic, particularly where money sums are concerned, who nevertheless cannot read the easiest two-letter words and can barely recognize the characters of the alphabet. Often their illiteracy is in part an inheritance; and their fathers and mothers prove to be persons of a rough irresponsible coster type, themselves unable either to write or to read. In the elementary school, with its big classes and mass methods of teaching, the poor reader is sadly penalized. Not only is he backward in English itself, but, as he cannot comprehend the textbooks of his grade nor read the arithmetic problems which he might calculate correctly once they were grasped, he drops behind, like Robert, in branch after branch of his curriculum. At an older age, the poor reader suffers another serious handicap. Not only is he shut out from many of the better spheres of employment to which his intelligence might otherwise entitle him, but he is equally cut off from all the boons of literature, from the most valuable mode of quiet recreation, and from the most helpful source of self-improvement, intellectual, æsthetic, and moral. To him every book is a closed volume. He remains, and feels himself remaining, an uncultured barbarian in the midst of a civilized



society, and is prone to act accordingly. The boy, therefore, who is bright but backward, may, if we will, learn nothing else that school usually teaches, but he should at least be taught to read.<sup>46</sup>

3. *Special Emotional Disabilities.*—Where an intelligent boy or girl of excellent health, attending regularly at school, with no innate intellectual defects whether special or general, still fails to make proper progress in his tasks, it becomes imperative to look for temperamental troubles. These are far more frequent among those whose intelligence is nearly normal or more than normal than among those who are congenitally dull. At times, some deep emotional disturbance of a kind we shall study in a later chapter lies at the root both of the child's apparent backwardness and of his moral faults. There may be some hidden hostility to the teacher, some unspoken dislike for a particular subject, some secret revolt against all authority and restraint as such—feelings, perhaps, of which the child himself may scarcely be aware. Psycho-analysis or treatment upon psycho-analytic lines, such as will presently be described, is then doubly necessary and sometimes doubly successful; it ends by restoring the child to a normal course both in school and out of it.

4. *Special Classes.*—As with the congenitally backward, so with the educationally backward, the most useful administrative measure during childhood is transference to a special class. Such transference, however, will now, as a rule, be temporary: after a year's individual coaching, he may be fit for the ordinary standard. If the child's lack of adequate school knowledge rests neither upon any inborn basis nor yet on any emotional antipathy, then proper attention to health and attendance and a tactful appeal to his natural interests should gradually lift him to the average level for his age. A sympathetic approach

---

<sup>46</sup> On the treatment of special intellectual defects I may refer to my London County Council Memorandum on Educational Attainments (*Mental and Scholastic Tests*, Memorandum III, pp. 265 *et seq.*); also to Dr. Augusta Bronner's *Special Abilities and Disabilities*, where the cases described and analyzed were largely drawn from studies of delinquent children.

is indispensable; school and school work should be made so fascinating that these young defaulters come actually to prefer lessons to truancy and the classroom to the street.

5. Change of Class or School.—Where a backward class or school is not accessible, often the mere removal to another class or school of the ordinary type may act as a sharp warning and liberate the child from the mutual friction that has possibly set in between him and his previous teachers. Particular care is needed when such a child is first promoted to the senior department. In the freer atmosphere of the infants' school he has had no occasion to rebel. But upon transference to the upper school, with its stricter discipline, its sedentary habits, and its call for uncongenial book and paper work, his blotted energy accumulates, and even if he does not try to shirk by truancy the shame and punishment to which his ignorance exposes him, he will be certainly in the mood to burst forth into antisocial conduct as soon as school hours are over.

6. Industrial Schools.—Often, however, the boy's delinquencies are not suspected until evil habits have been formed. Backward in school, he has been presumed too stupid to engage in any deep-laid stratagems outside the walls of the classroom. Hence, when at length he is unmasked, he is already hardened; and firm measures are essential. The older boy with such a history, deaf to all sense of honor and too far advanced in tricks of cunning to respond to simple probation, often rallies and turns out well when he finds himself in an industrial school. His intelligence, of a level comparatively rare in such an institution, will enable him to be entrusted with monitorial power, and the responsibility will favorably react upon his character and self-respect. On the other hand, his poverty of school knowledge, glaring as it would seem among normal boys, is there no longer so exceptional. He ceases to be marked down as an acknowledged dunce, and to the practical type of work that is now becoming more and more general in these institutions, he takes with a will.

7. Choice of Employment and Suitable Vocational Training (Simple Trades).—Most of these backward but intelligent boys belong to the same intellectual category as those who, when

adult, get their living by some simple trade. Usually, in the certified schools the teaching of such trades is the central feature of the instruction given. Of the boys who leave, about 24 per cent find skilled or semi-skilled employment, but during the past three years the proportion has unhappily diminished.<sup>47</sup> The occupations are sufficiently varied: carpenters, metal workers, shoemakers, gardeners, tailors, mechanics, bakers, painters, and even printers are drawn from the ranks of the industrial school. There should, therefore, be ample scope for careful vocational guidance, and so far as practicable each boy should be trained at the work he is likely to take up.<sup>48</sup>

At the reformatory and industrial school the girl who is merely backward fails to do so well. Too commonly it has been

---

<sup>47</sup> 27 per cent in 1921; 23 per cent in 1922; and 21 per cent in 1923. (My calculations, as before, are based on the detailed figures given in the last *Home Office Report*; see *loc. cit.*, 1924, Table VI (a), p. 78.) No doubt, as soon as the amount of general unemployment begins appreciably to lessen, the proportion will once more resume its rise.

<sup>48</sup> I name each trade in order of frequency. Year by year the list is becoming longer and more diversified. Unfortunately, however, less than 6 per cent of the boys, on their discharge, get employment in the particular trades which for two, three, or even four years, they have nominally been learning. This is due partly to the limitations under which the schools are forced to work. The trade instruction given—in tailoring and shoemaking, for example—is upon coarse materials necessitating a rough and somewhat clumsy workmanship, not the finer technical skill required by shops and firms outside. Often the boy does not leave the industrial school before he is sixteen, or the reformatory before he is eighteen; he may then find himself compelled to unlearn what he has picked up, obliged to compete with lads with two or three years' start of him, and reduced to accept the wages of a boy of only fourteen. It is claimed, of course, that the trade training has an educational and a moral function, but the theory upon which such a claim is based modern psychology disputes. The execution of repairs and the making of clothes may be of value to the school; it can be of little value to the boy himself. The failing is fully realized, and of late in many subjects of instruction—in carpentry and woodwork, for instance—the standard of work has markedly improved. Better results would probably be obtained if the schools carried still further their tendency to specialize: I venture to think that many of the schools aim at too wide a variety of vocational training. Could each boy be given first of all a period of trial and testing to determine his natural bent or aptitude and then sent to some particular institution concentrating on his chosen form of work, much time and trouble, much money and material, would be economized, and the boy's efficiency, prospects, and contentment would be notably enhanced.

assumed that for such a child there is but one career—domestic service. Ill-educated in reading, writing, and arithmetic, she is judged incapable of anything but menial work. Yet menial work, useful as it may be to the institution, imparts little or no progressive training, and it is against this very kind of occupation—scrubbing floors, cooking dull but wholesome meals, washing plates and dishes, day after day, at the same hour and in the same fashion—that the girl of high spirits and moderately high intelligence is most inclined to mutiny. When her course at school is over, she will be the least likely to remain in a monotonous situation however excellent, at the beck of a mistress however sympathetic, with most of her evenings and week-ends to be passed indoors at her place of employment. To factory work and to laundry work she may turn more genially. But provided she is merely backward and not inherently dull as well, such a girl does best if sent to one of the smaller homes where she can be taught some trade, like dress-making; <sup>49</sup> such a trade will call into play more of her natural capacity and be likely to lead afterwards to a freer and more independent life.

8. *Inculcation of General Interests and Information.*—With every delinquent an effort should be made to build up healthy and progressive mental interests. "Culture," it has been said, "is half-way to heaven." <sup>50</sup> And nothing is likely to kill a passion for something criminal except a greater passion for something more refining. With the child whose ignorance is general as well as scholastic, the need for a broader type of education is redoubled. For such a case, whether in the industrial school or at the ordinary school, the traditional curriculum might with advantage be extended. Among its aims, it might include not merely instruction in the three R's and the teaching of a useful trade, but also the transmission of those wider and humaner interests, of those floating stores of common knowl-

---

<sup>49</sup> Of the girls trained in certified schools less than 4 per cent take up dressmaking when they leave: the proportion, however, seems to be increasing. On the other hand, as already mentioned, no less than 64 per cent enter general domestic service (compare *Home Office Report*, 1924, Table VI (b), p. 79, figures for 1921-23).

<sup>50</sup> George Meredith, *The Ordeal of Richard Feverel*, Chap. xii.

edge and popular information, of those ideals of simple culture and simple intellectual enlightenment which to children of more prosperous parents would ordinarily be supplied at home.<sup>51</sup>

<sup>51</sup> To discuss in detail what modifications, if any, should be introduced into the school curriculum to meet the needs of the delinquent boy or girl is a matter that falls outside the limits of this book. The reader will find many suggestive hints in the "Outline for the Institutional Education of Young Offenders," published by W. Healy and A. Bronner in *Journ. Educ. Psychol.*, VI (1916), v, pp. 301-16.



## CHAPTER VIII

### INTELLECTUAL CONDITIONS: SUPERNORMAL AND SPECIAL ABILITIES

*Che dove l'argomento della mente  
S'aggiunge al mal volere ed alla possa,  
Nessun riparo vi può far le gente.*

For where the reasoning of intellect  
Is joined to evil will and equal power,  
What guard or remedy can man select?

DANTE.<sup>1</sup>

### Supernormal Ability

A clever young thief of fifteen, a small and sturdy lad with bright red hair and bright blue quizzical eyes, walked into my room one day bringing a note of introduction from his former teacher. He had a long column of offenses debited against his name, and marks among all my acquaintances the nearest approach I have found to the master criminal in the making. I may, therefore, be pardoned for transcribing his story in full.<sup>2</sup>

From infancy upwards he had everywhere been noted as a

---

<sup>1</sup> *Inferno*, XXXI, 55; J. I. Minchin translation.

<sup>2</sup> *Age*: 15½. *Home Circumstances*: One of six children. Father, cabinetmaker (50s. per week), of a somewhat domineering nature; mother, staid, intelligent, religious, and hard-working. Four rooms for six persons (rent 11s.), clean and well kept.

Of the children left at home Nipper is the eldest but one. An older brother and sister married young. There are indications that they had found the father difficult to live with, though there was no open quarrel or breach. A daughter of 17 remains, unemployed at present and helping at home: she and the younger children are quiet characters who meekly accept the father's domination. Indeed, Nipper himself, in his own home, has always been outwardly obedient and docile.

*Family History*: All the other members of the family seem of a dependent disposition, a little obtuse and taciturn, with no more than aver-

forward child. Before he was eighteen months of age he could recite nearly all Mother Goose's rhymes, and was of course held up as a marvel of precocity. At school he rose to the top of each grade in succession. When ten and a half he gained a scholarship to a secondary school. But his father, too poor to maintain him, compelled him to decline. The boy, however, was drafted to a central school where he received a sound education, commercial as well as general. This school he left before his time was over. Impatient for his wages to swell the family income, his parents thrust him into the first opening to offer itself—a job in a small firm, combining the dull and triple task of delivery boy, errand boy, and office boy.

Nipper, as he was nicknamed from his diminutive size, was induced to accept the post by an assurance that he might soon

---

age intelligence. In mentality and physique (*e.g.*, his small build and ruddy hair) the boy differs so greatly from all his relatives that doubts have been cast upon his legitimacy.

*Physical History and Condition:* Born after an 8 months' pregnancy: weight, 7 lbs. "Always a precocious child"; (talked at 9 months, walked at 11 months). Measles at 5; was delicate for the next 2 years, and was treated with thyroid extract, but shows no direct symptoms of endocrine deficiency. Health at present excellent. Knee jerks brisk. Has smoked cigarettes from the age of 12, more as a manly affectation than from a genuine desire. Height, 141 cm.; weight, 34.3 kg. (about two years below normal). Pubescence delayed. Rufous type; freckled. Is dressed with particular attention to necktie, collar, tie pin, and socks, and hardly enough to boots.

*Intelligence and School Attainments:* Mental age: at 10.0 (as tested by teacher with Binet tests), 13.5 years (mental ratio, 135); at 15.0 (with group tests), 16.5 years: (mental ratio, 110; but the intelligence of supernormal children of these higher ages cannot be properly expressed in mental years: in the technical terms of the less usual formula, the boy's level is about  $2\frac{1}{2}$  times the "standard deviation" above the average for his age; this means that he would rank as the top child in a representative sample of about one hundred). Reading, Spelling, and Arithmetic, about 15.5 years; Handwriting, Drawing, and Handwork, about 15.0 years; General Information, 16.0 years; (again these assessments are arbitrary and approximate only). Auditory memory, visual imagery, and verbal fluency, all unusually well marked. In tests of report the boy shows marked contra-suggestibility.

*Temperament:* Active, somewhat unstable (instability aggravated by approach of puberty, and by passive suppression at home). Repressed antagonism to father; slight signs of an inferiority complex, and of simple sexual complexes (see text).

work his way upwards to a higher place upon the staff. After twelve months' humble service, he asked for an increase in salary and rank. He was refused. Now the boy's abilities were superior not only to the needs of his own position, but also to the abilities of the manager under whom he was drudging. Several small improvements had, as a matter of fact, been introduced by him into the running of the office and the keeping of the books. But after this repulse his enthusiasm waned. He began to sharpen his wits for his own benefit instead of his employer's and at last to use his cleverness dishonestly at his employer's expense. He stole, first the time, then the stationery, later on the stamps, and eventually the takings of the firm.

So successful was he, to begin with, that he presently grew careless, and soon a long list of depredations was tracked down to his door. All this time, too, his private extravagance was costing him dear. As an offset to the threadbare sameness of his day-to-day routine, he had plunged into a variety of gay amusements—gambling, betting, the music hall, the boxing saloon, and a frivolous life with the opposite sex. His character, said the head of the business, could be put in nine words: "Fond of a ribbon, and fit for the rope."

No doubt, the debts that his spendthrift ways had brought upon him were in part a motive for his thefts. But, as a closer knowledge of him showed, the main cause of his delinquency was the pernicious and perverted twist taken by his inventive intellect. In company he was an entertaining chatterbox and could say a smart thing neatly. For the quiet and comprehending listener, his glib conversation flashed many a sidelight on what was passing in his mind. Thus casually exposed from time to time, his thoughts seemed always brimming with plans for criminal adventure, most of them evolved by his own fertile fancy, some doubtless borrowed from fiction and the films. Many of his notions he would narrate as an exhibition of ingenious wit; one or two were put into practice, "just to show that they would work." "What a lark," he one day suggested, "to go round with a dummy pillar box [letter box]. You'd stick it by the curb; watch 'em drop in their P.O.'s and checks; sort

your haul; and then on to the next street corner." To track the milkman on his rounds, stealing and redelivering for cash his little cans; to renumber at nightfall all the doors in the street and to entrap some wealthy stranger; to "burgle" the houses of burglars; to pass off false coin on counterfeiters,—these were among his cheap little sparks of paradoxical humor and invention. Fantasies of crime, indeed, seemed forever to be spinning within his imaginative brain.

One money-making dodge, drawn from the tricks of the bogus auction room, he had adopted on several occasions with much profit to himself. His method deserves a detailed description. On pay day during the dinner hour it was his custom to turn up with his pockets and luncheon basket stuffed with innumerable articles dear to the young boy's heart—an old watch, four or five pocket knives, two or three fountain pens, studs, cuff links, tie pins, and an odd assortment of shilling novelettes. His usual gambit was to set his fellow office boys bidding for the smaller trinkets, and then with a show of generosity to return the purchase money with the goods, saying he "wouldn't take cash from a pal." Presently, he would put up a fountain pen "cheap for three bob [shillings]." Some gullible boy would bid, hoping to get the money back as before. "Now hand over the dibs, old man, and see how handsomely I'll treat you." The prospective purchaser, not having the exact change, offered on one occasion two half-crowns. "Right," said the junior auctioneer, "in a minute you shall have them back." Other articles were sold, to the constant accompaniment of a jocular patter. "Now—you who bought the fountain pen, what will you bid for this watch? Worth two guineas. Specially cheap as a favor to you. Here's a bargain: fountain pen, watch, and your own five bob, all the lot for half a quid. No? Well, say—going for eight bob, seven bob—six bob!" The victim, becoming the center of general attention, grows flurried and flushed. He has been fearful lest neither his change nor his fountain pen should be forthcoming; now in his eagerness, as the whole packet is held out to him, he fancies he is getting both his money and his pen, with a more or less unwanted watch thrown in, just for one

extra shilling. He takes the packet; gives the six shillings; and turns away to count his gains. This little incident I witnessed myself. When the sale was over, the victim was still muttering he "knew there was a catch in it"; but it cost me fully ten minutes to explain to him the fallacy of buying one's own money with a further sum. The young huckster's arithmetic was too quick for him.

Altogether, to reverse the dictum of Heine, Nipper was certainly *Kein Charakter, doch ein Talent*.<sup>3</sup> To his parents, the disclosure of his prolonged misconduct came as a heavy and unlooked-for blow. Like many of the more intelligent criminals, Nipper was one who led a double life. Within the family circle he was a pattern son and a model brother: at school and wherever he had found just treatment and discerning friends, he was known simply as a bright little boy with the rather obstreperous ways of an uncultivated upstart. But, in his own most intimate daydreams, he played a different rôle: always he was the romantic rogue, the runagates' champion, redressing his own wrongs and those of others, a valiant composite of all the outlawed heroes, from Robin Hood to Raffles.

Apart from a latent grudge against both his father and his employer, a grudge which he professed to laugh over but which he felt acutely at the bottom of his heart, there was no inherent evil in the boy's own disposition. He admitted his tricks, and justified them, with all the sophistry of "Mr. Sludge, the Medium," as a mode of exacting reparation from a world too silly and too selfish to admit his own superlative deserts:

". . . Made fools of them?  
I found them ready made!"<sup>4</sup>

Here, again, it is possible to report success. By the bounty of a friend who refunded all the suns embezzled, this incipient young felon was rescued from a police-court charge. He was found a better job; sent to an evening school; encouraged to find intellectual recreations; and, two years later, was promoted

<sup>3</sup> "Not a person of character, but certainly one of talent." (*Alta Troll*, k. 4.)

<sup>4</sup> Browning, *Dramatis Persona*, *loc. cit.*, ll. 231-2.



to a responsible post where his high abilities, formerly wasted and running riotously to seed, could be used, appreciated, and absorbed.

Supernormal intelligence is thus by no means incompatible with criminal folly. Yet among the ordinary run of delinquents a high degree of supernormality is conspicuously rare. In my total list of cases no more than 2.5 per cent are of central school or scholarship ability, and only 1.5 per cent are equally advanced in educational attainments.

The notorious criminals of history have captured a disproportionate interest by dint of their intellectual brilliance. Benvenuto Cellini, statuary, sonneteer, the greatest goldsmith of his time, and the charmingly egotistical autobiographer of his own misdeeds, Villon, poet and thief, Eugene Aram, philologist and murderer, Vidocq, burglar and police detective, Professor Webster, the skilled American chemist who used his own laboratory to cremate the bodies of his victims, Thomas Henry Wainwright, the art critic and art collector who poisoned his insured relatives to pay for his gems and antiques, these are but a few of the talented scoundrels who still cast a sentimental spell over the amateur in crime. They, however, are exceptions. Nowadays, the man whose temperament or upbringing might have turned him speedily enough into a jailbird had he been devoid of a sound intelligence, is commonly saved by that intelligence not merely from detection, but even from anything palpably illegal; it is still easy for a perverted genius to swindle the public and grind down his dupes and yet all the time to keep shrewdly within the bounds of the law. A fortune-hunting trickster, he lives, in the common phrase, "upon his wits," and his wits support him without scandal. Master criminals, like Moriarty and Arsène Lupin, who steal and murder outright for years without discovery, are, fortunately for human welfare, as rare in fact as they are ubiquitous in fiction.

In the young great ability is never of itself the sole cause of crime. Not once have I found occasion to enter superior cleverness under the rubric of a major factor. Where it comes into play as a secondary cause, the real trouble flows usually from some adverse situation which the child's intelligence only

in part assists to create—from a disparity between the sharpness of the child and the dullness of his parents or between the child's high capacity and his low class in school, or between his far-reaching ambitions and his narrow and monotonous vocation, or between his own cramping poverty and the comparative wealth of the associates amidst whom his high talents have thrust him. Generally, too, there is some added temperamental factor—some powerful instinct, some inner emotional upheaval—which precipitates the final outbreak. For the rest, a quick intelligence inspires the method rather than the motive of the crime. Often the wrongdoing itself is of an unusual order—deep, subtle, intricate, smartly schemed and cunningly concealed, and the wrongdoer gloats in private over the dexterity of his feats. Forgery and many of the more elaborate kinds of fraud and swindling are crimes that no foolish or illiterate youth could ever devise or execute. From the sheer adroitness of the offenses the child's high level of ability can often be deduced.

### *Treatment*

Few of us, however capable, however righteous we now take ourselves to be, have never perpetrated a criminal act, never experienced a criminal temptation. We view such lapses as exceptional, or think we have grown out of them with the growth of wisdom and experience. In a woman's training college, famous for its faultless tone, a recent chance investigation, through anonymous replies to a general questionnaire, showed that, on their own admission, nearly 40 per cent of the inmates had in their earlier days committed at least one theft; yet every one had returned to honest ways, without external assistance, and usually, except for accident, without any discovery of the slip. A first fall from virtue, therefore, in an over-intelligent child will not be too anxiously regarded by an equally intelligent parent.

1. *Passive Expectancy.*—In the greater number of these cases, the child's own good sense may be trusted to work a spontaneous recovery, and the best policy is to wait and hope. In certain bodily diseases physicians have familiarized us with

the use and the efficacy of what they call an "expectant treatment." The patient with pneumonia is placed in hygienic surroundings, made comfortable, silently watched, and, for the rest, left undisturbed by fussy intervention: Nature is given a free hand to bring about a gradual cure herself. In moral disorders, as in physical, the same principle may be applied. The most brilliant reforms reported by "little commonwealths" and colonies under "free discipline" are of children whose energy and ability are above the normal. These quiet, quasi-Montessorian methods are excellent for the short, sharp moral breakdowns of those whose mental constitutions are at bottom healthy and strong. If the child is charged early before the court, a period under probation is generally the most that is required.

2. *Investigation of Causes.*—There come, however, from time to time, cases and occasions when the most vigorous steps are needful. When at length a clever delinquent has been detected and brought for examination, it can often be inferred from the simple fact of his high intelligence that he has enjoyed an unusually long history of triumphant crime, and that he is, therefore, by now in the grip of habits as obstinate as they are old.

Further, should these habits persist into adult life, he is in the way of becoming one of the most dangerous menaces to the community; for, of all criminals, the adult of supernormal ability is by far the most destructive and by far the most difficult to detect. He must, therefore, be checked while young. The cases of this kind, brought to the consulting psychologist, are seldom cases of a first and isolated lapse. Hence, the question that, as a rule, confronts the examiner is not—why has this child committed this crime? but rather—why has he persisted in his delinquencies so long that at last he has been found out? or, perhaps, why has the first plunge assumed a shape so desperate that an appeal to an outside authority has seemed at once imperative? Nothing but a detailed study can furnish the reply. And just because the child's mind is so subtle, so complex, and so highly organized by nature, the requisite inquiry must be protracted and profound. A mere testing of

abilities is by itself of little worth. Where a supernormal child takes to a career of persistent delinquency or suddenly dashes into flagrant crime, there in the background, as we have noted, some deep emotional pressure is likely to be at work; and what the psychologist will really be concerned with is not the child's intellectual quality, but some distressing experience, some environmental disturbance, or some sore and irritated spot in the tender places of his mind. The first essential of the treatment, therefore, is to search for these complicating factors.

3. Change of School or Class.—Often, we have seen, some want of adjustment may be suspected in his school, in his home, or in his place of business. At school the maladjustment is easiest to discover and relieve. In the secondary school the bright delinquent is usually the winner of a scholarship; his own poverty and uncouth ways and the seeming snobbishness of his fee-paying comrades sets up a secret antipathy which issues at last in some act of theft, defiance, or impropriety—the chain of causation we have already seen at work in the histories of Edith D. and Martin G. The kindest measure is not to deprive the child of his scholarship (unless, indeed, it is too late to expect a cure), but to change him to a school where the social differences are less pronounced—to a county secondary school perhaps, instead of the high school or the public school. In the elementary school the situation is still more simple. Just as the backward child may be working in a class too high for his true capacity, so the forward child may be left in a class too low; the lessons and tasks set before him are not hard enough to drain off his excess of mental vigor. Here, too, he may form pernicious partnerships with older but duller companions; and infected with their own degraded standards, he will play the desperado and revel in the startled admiration which his daring feats command. In such a case the remedy is plain. The mere promotion of the bright delinquent to a class more closely answering to his actual talents, with the addition, it may be, of extra but still interesting homework, will often suffice to sever his connection with the little gang of which he was the leading spirit, and to absorb in more

legitimate pursuits his own superfluous energy and misdirected skill.

4. *Change of Home Surroundings.*—More often, however, the maladjustment lurks in the home. As educators most parents are, and must be, mere amateurs, and the harm that their efforts may unwittingly inflict on the bright and spirited youngster near the dawn of adolescence has been a favorite theme with the novelist and dramatist. "Home! parents! family! duty! how I loathe them," cries the brilliant but wayward heroine in Bernard Shaw's tragi-comedy; "the fiendish selfishness of the old and the maudlin sacrifice of the young can be more unbearable than any poverty, worse than any right-down wickedness."<sup>5</sup>

The most frequent and most serious cases are those where the intelligence of the child is superior to the intelligence of his controlling parent, where a swan has been hatched in a nest of fluttered ducks. The trouble may have had its first origin in some petty domestic friction, some reproof perhaps which was unjustified, some punishment which the child was quick enough to see was misplaced, but which the father and mother were too slow to amend. If an argument followed, probably the child had the best of it; and the parent retreated, with more dignity than tact, behind the bulwark of his *patria potestas*. The child retaliates by reasserting, in deeds as well as in words, his own superiority of mind, and every effort to restrain him is accepted as a stimulating challenge to outwit and outflank the restraint. Sooner or later he may slide into the error, shared by so many geniuses, of assuming that the world at large is as much beneath him in wisdom and astuteness as the narrower circle of his own little home. He becomes an avowed and reasoned revolutionary.

In such a case it is advisable to remove the child from his family and to place him under more judicious control. A public institution is seldom a fit place: a public school, when available, is often excellent. Private assistance, however, can often be solicited with success, owing to the interest which the clever miscreant can nearly always count upon.

---

<sup>5</sup> *Misalliance: with a Treatise on Parents and Children*, p. 36.



5. *Choice and Change of Employment (Semi-Professional Work, Technical or Clerical).*—Where the maladjustment lies not in the home but in the vocation, the trouble is less easy to repair. So far as intelligence is concerned, the boy or girl of scholarship ability is fit to enter at least the lower fields of professional work, if not the higher. Apart from their delinquencies, the brightest would make good teachers or proficient engineers; others, together with those of central school ability, would do well in technical posts of an easier grade, in the simpler executive posts or the better commercial posts, or in some clerical position that might offer a fair prospect to their talents: for which of these several lines a given child may be best fitted is a point to be determined only after a closer vocational study; and, as I shall urge in a moment, with the boy of supernormal mind, a psychological examination of his special occupational bent is always well worth while. Nevertheless, for any place like those just mentioned, honesty, good faith, and a steady character are rightly demanded as essentials. Hence, the bright delinquent finds himself, as a rule, deprived of the superior chances for which his abilities have marked him out. In some cases the exclusion is made too hastily: and always it is to be borne in mind that, provided dishonest habits are not yet firmly fixed, by far the best way to imbue a youth with a proper sense of responsibility is to set him in a responsible position.

Where delinquency has followed, not preceded, the choice of occupation, this argument holds yet more strongly; but, unhappily, the right remedy will be yet harder to secure. Thwarted ambition is a common foundation upon which an antisocial attitude is slowly but solidly built up. With rare good fortune, indeed, it may still be possible to procure for the youth a fresh and more fitting employment where his capacities may find full scope and play. More frequently his friends must rest content with redirecting his talents into some non-vocational hobby, some congenial interest to be pursued in leisure hours. Here advice as to the choice of a suitable club, a suitable evening class, or a suitable day continuation school, may be most helpful.

6. *Industrial Schools and Reformatories.*—With numerous exceptions in respect both of institutions and of individuals, it is, as I have just intimated, a sound rule that the industrial school or the reformatory is no place for the supernormal child. The general mental level of the inmates is below, never above, the average. Almost all such schools are characterized, perhaps inevitably characterized, by a want of higher technical and scientific teaching: in none, so far as I am aware, is there any training in electrical work, in the finer branches of skilled engineering, or the practical physics and chemistry so essential to many modern trades.<sup>6</sup> Were it possible, with increased classification, to establish a kind of central or higher grade school of an industrial type, the brighter boys and girls might do well there. In many schools the abler and older child may become a monitor, prefect, or “N.C.O.” But too often the appointment is made by the superintendent, not by the free votes of the pupils themselves; and real authority is seldom entrusted to the pupil so appointed. Where genuine self-government in minor matters has been established, where (as in one or two places) a junior judge and jury are elected to try all breaches of good order, there both the clever child himself and his own companions may profit by his entrance into the school.<sup>7</sup>

---

<sup>6</sup> It is the cost, not the will, that is the chief stumbling-block; what may be done even in the face of obstacles by the provision of a good all-round training in metal work is shown by the admirable results obtained at Redhill, Surrey.

<sup>7</sup> Since the above was written an interesting experiment has been undertaken in changing Elm House Industrial School, one of the Protestant Schools for Girls, into a small central school. Into this school it is now possible to draft by competitive examination those girls from certified schools all over the country who show ability above the average and by character and conduct merit special opportunities. Here and elsewhere, through the facilities offered by the London County Council or other local education authorities, girls or boys housed in Home Office schools may even attend a local secondary school and evening and other classes. These are new improvements that might well be extended. The results would undoubtedly justify them. Already one boy from the Carlton Training School has passed the London Intermediate Examination for the degree of B.Sc., another pupil from Hereford has recently passed the Teachers Preliminary Examination, and several boys and girls from different schools have passed the Oxford Local Examination or the London Matriculation.

7. *Rational Argument.*—Where removal from home is impracticable, the position must be carefully put before the parents; and, if possible, some kind and sagacious visitor found to act as a constant adviser. Unless the parents have an intelligence at least equal to that of the child, it is useless to ask from them anything more than an attitude of patient passivity. We must rely upon an appeal to the child's own better sense for achieving a self-reformation: we must be rational as he is rational, and meet him and beat him upon his chosen battleground. A bright adolescent is usually equal to, and often interested in, the philosophical discussion of ethical problems. He will respond, sometimes with great eagerness, to questions put sympathetically to him in the spirit of Socrates, questions that raise the big fundamental issues of morality. In secret, no doubt, he has already been broaching these problems for himself, and will be amazed to learn that his own assumed philosophy—usually some crude form of hedonism, half thought out by the aid of current catchwords—conforms to a recognized historical doctrine whose merits and fallacies were long ago debated and still lie open to dispute. With the reflecting child this abstract line is far more profitable than taxing him with concrete petty misdemeanors of his own. His, indeed, is the only case where that cherished weapon of the children's counselor—logical or would-be logical argument—is ever likely to do good. If, however, external discipline and sharp correction seem also requisite, dialectics had best be postponed. A frown or a blow can have strange acoustical effects, and leave the listener deaf to the best logic in the world. Chastisement, therefore, should rather be inflicted in the spirit of "the Prooshian Bates": "We understand one another so perfectly, Beetle, that I'm going to pay you a tremendous compliment: I'm going to lick you, without giving rhyme or reason."<sup>8</sup>

But as a general rule the bright child is better left to correct and discipline himself. And in any case injunctions, prohibitions, and reprovings should be reduced to the bare minimum. Should justification of them be thought desirable, the appeal should be based not upon the immoral or the irreligious

<sup>8</sup> *Stalky and Co.*, p. 34.

character of the child's past or possible actions, but upon their foolishness, their ultimate certainty of non-success, judged from his own worldly standpoint. And whether the grounds be given or whether they be withheld, the few restrictions imposed and the few penalties foreshadowed should be firmly, consistently, and unflinching followed up.

### Special Abilities

So far we have had chiefly in view the child's mental level as a whole—his general intelligence. To examine his special mental capacities is almost equally imperative. The psychologist who is content merely to determine an all-round mental age with the Binet-Simon tests has barely begun to psychologize. The child's intelligence may be perfectly normal; yet, as we have seen, some limited disability in some single intellectual function—memory, attention, observation or the like—may unfit him for school or business and so give rise to social maladjustments that may in the long run lead him into crime. Or, on the other hand, where his intelligence is poor, some specific gift may yet be discoverable—some peculiar talent, which in the past has perhaps served his puerile enterprises and which in the future may offer a peg for more reasonable interests and a handle for a more effective training. Over 7 per cent of my cases suffered from specific disabilities, and an even larger proportion showed marked specific aptitudes.

Upon special disabilities I have already touched in dealing with educational backwardness above;<sup>9</sup> they have but an indirect influence in the production of delinquency. Specific aptitudes deserve a fuller notice, since the part which they play is more prominent. Three forms of special ability occur among my cases, and show a clear relation to the crimes committed—manual dexterity, verbal facility, and the power of a vivid imagination.

#### 1. Special Motor Capacity

The boy whose abilities are practical more than academic, mechanical more than intellectual, may easily be tempted to

---

<sup>9</sup> Page 329.

use his nimble fingers in his spare time upon exploits profitable but dishonest—picking pockets, forcing locks, coaxing pennies from slot machines with twisted hairpins, or sweets with flattened discs of lead. The manual or constructive skill so demonstrated comes often as a revealing surprise to his teachers, who knew him in class as nothing but an inert and ignorant sluggard; and when a more suitable curriculum brings more wholesome outlets for his dexterity, the boy's misdoing may cease. The results of a bent in this particular direction have been sufficiently illustrated by the case already described.<sup>10</sup>

## 2. *Special Language Facility: the Verbalist*

Many young delinquents, including some who are definitely dull or defective, can disguise their shortcomings, both from others and from themselves, by an unusual gift of glib and voluble talk. Judged by casual conversation, by a superficial interview, or even by verbal tests like those in the Binet series, their wits may appear far keener than is actually the fact.<sup>11</sup> In temperament the fluent chatterer is often vain, vivacious, and assertive, and can impose upon the stranger with a long and plausible recital of the unjust way in which the world has used him. He has a quick, excitable brain; and, by the incautious listener, mental activity is too often taken for a sign of mental excellence. At an older age, the very unevenness of his powers becomes itself a source of trouble. The ready reception and the misplaced credit which his favorable first impression so uniformly wins for him blind him to his real incompetence. He may throw up some humble mode of livelihood for a more ambitious one in which he can never hope to succeed, and takes his turn as a commercial traveler, a public speaker, or a social agitator. The open-air pulpit or platform often captures such a type. Then, after failing to utilize his limited gift in a

<sup>10</sup> Robert N., page 325.

<sup>11</sup> Their chief failing is a weakness in judgment, in foresight, and generally in what I have elsewhere termed the "higher mental processes." These are qualities best measured, not by the usual kind of intelligence test, but by tests of reasoning and by some of the harder performance tests—by exercises in abstraction, in complex apperception, in ability to plan, and in capacity to make a mental representation of systematic analysis of concrete situations.



legitimate field, he easily swerves into a dishonest path and exploits his verbal facility for the concoction of specious and persuasive tales—begging, swindling, perpetrating frauds, and engaging in groundless and aggressive litigation. Among delinquents of all but the grossest kind, at every age from infancy upwards, the verbalist is a type that is repeatedly met with.

### 3. Special Mental Imagery

A still more common equipment of the juvenile offender is a strong imagination. Imagination, as the word is loosely used in popular parlance, involves both a general and a special ability. It consists in part of a power of mental construction, of a lively and original inventiveness, itself in turn dependent on a fair measure of intelligence; but in part it is the consequence of a more specific gift—the gift of clear and plastic mental imagery. The latter is the component that concerns us here. The imaginative child must have the knack of summoning up concrete ideas and of manipulating them in his mind without the aid of present sense perceptions: he must be able to build up thoughts as others build up things. With some romantic creatures, these mental images are infinitely more realistic than with the rest of us and attain the force of an hallucination. The vivid visualizer in the first few years of life finds it far from easy to discriminate what he has actually seen and what he has inwardly pictured. When older, he may prefer the inner vision to the outer, and luxuriate in a life of daydreams. Sending his fancy out upon the wing, he now regales himself in private upon fictitious self-indulgences, delights he could never hope or dare to find in literal reality. Such reveries are the opiates, the habitual anodynes, of an unhappy or restricted childhood.

In vacant or in pensive mood,  
They flash upon the inward eye  
Which is the bliss of solitude.<sup>12</sup>

In their origin, these mental pictures may be glorified memories of past incidents or fantasies of possible and im-

---

<sup>12</sup> Wordsworth, *Lyrical Poems*, "I Wandered Lonely," st. iv.

possible adventures such as the boy aspires to in the future. In their effects, they may be harmless, debilitating, or positively dangerous. The mere intensity and clarity of the idea—of the scene photographed upon his fancy or of the summons echoing within his heart—may keep alive for him some thought or recollection embodying a criminal design. Like Macbeth's "fatal vision, the dagger of the mind," they "marshal him the evil way that he must go."

The youthful power of fancy quickly fades, and the facts of the imaginative life are so soon forgotten, and so easily overlooked, that their import needs insistence at some length. What the child's actual perceptions are we can usually infer; what he sees daily about him we know from our study of his environment; what things he hears in the company he keeps, it is seldom difficult to guess. We fail, however, to recognize that, with the young, these genuine sensations of sight and sound may take up no more than a tiny corner of the inner panorama of the soul. We have, therefore, to inquire amid what secret scenery and among what mental furniture the child habitually dwells, what painted windows, what storied walls and animated pictures rise before him when he retires within the little stronghold of his mind.

A practical study of the mental imagery of each criminal is especially incumbent when we are trying to analyze the immediate antecedents of his act.<sup>13</sup> With the doubtful excep-

---

<sup>13</sup> Tests for the power of mental representation and for the vividness of mental imagery of various kinds are given in the manuals of psychological examination (*e.g.*, Whipple, *op. cit. inf.*). I may mention, more particularly, the illuminating results to be elicited by the ingenious tests devised by Miss Winifred Spielman for estimating creative imagination—tests shortly to be published in a report of the Industrial Fatigue Research Board on *Vocational Guidance*. The methods are partly those of the ordinary intelligence test appropriately modified and partly those of a special questionnaire. The unexpected information that may sometimes be evoked by these simple means is well illustrated by a reply given to her in answer to one of her questions. The question put was this: "What is the most important thing you have ever invented?" A boy not known to be delinquent, with a chronological age of thirteen and a mental age of ten and a half, wrote down: "A way of getting gas without putting money in the meter by a hole in the pipe and fixing a smaller pipe [where] it won't be seen." More, however, is usually to be learnt from an indirect than from a direct procedure—by noting inci-

tion of certain instinctive and habitual movements, no deed so deliberate and so complex as a theft or an assault is ever carried out without some idea or image of that deed preceding the deed itself. Conversely, every image or idea that is entertained by the mind tends to work out its own realization in corresponding conduct. This double truth is at bottom but a general law of the nervous system: the flow of nervous energy is always from the sensory side of the body towards the muscles. With every one of us and, most of all, with children, mental thoughts are mental tendencies. Every idea of movement is in part a disposition to make that movement. To hear another cough, to see another laugh or yawn, is in itself a provocation to cough, or laugh, or yawn oneself. Ideo-motor action is not the rare pathological phenomenon it was at one time thought to be; it is the basic process of the normal mind stripped bare of all complicating accessories and checks.<sup>14</sup>

The mere entrance of a suggestion into a man's head, then, may be a sufficient reason for his hand to carry it out. Accordingly, the actual contents of the criminal's mind at the moment that he commits his crime may shed a flood of light upon his actions. What was he looking at, thinking of, wishing for, what was he fancying or recollecting—just before, and during, his actual temptation? A bright, willing, introspective girl can usually give a clear report of what her consciousness contains. With most children, however, much tact and some technical expertness in psychological cross-examination are requisite for extracting a trustworthy account. Unpracticed in self-analysis, with neither an interest nor a vocabulary for the elusive processes of the mind, the average healthy English schoolboy will

---

dentally the child's mental processes in the course of other tests, and in his ordinary conversation and everyday habits: his spontaneous introspective comments on the working of his own mind are always of especial value.

<sup>14</sup> "I sit at table after dinner," says James, "and find myself time after time taking nuts or raisins out of the dish. I am hardly aware of what I do. I make no express resolve; but the mere perception of the object, and the fleeting notion of the act, seem fatally to bring the act about." (*Principles of Psychology*, Vol. II, p. 522.) This might serve as an apt description of the mental state of many a simple-minded criminal during the actual perpetration of his crime.

only reply: "I don't know what made me do it. I don't know what was in my thoughts. I was thinking of nothing in particular." The psychological tyro takes such phrases literally and records that the child carried out his theft without a motive and even without a consciousness of what he was about.

From my own juvenile cases I have been able to gather considerable data upon the contents of the child's consciousness at the crisis of his crime. It would seem that, with some notable exceptions, his mind is aware of no clearly formulated plans, no arguments or self-questionings expressed or expressible in words. His thoughts are chiefly pictorial—ocular representations of some concrete object or some definite scene, each realized with sensuous vividness before his inner eye. Children are visualizers, and a visual image of the thing desired, of the place to be visited, of the process to be carried out, is the commonest precursor of the actual deed. Maisie,<sup>15</sup> for example, young as she was, could tell me how all through lesson time she was gazing in fancy at the bright new "chocolate shop," the pretty boxes of confectionery in the window, and the silver money held in her open palm. Another little thief, an impressionable boy of thirteen, told me quite spontaneously: "I saw the sixpence lying on the mantelshelf. I knew it would be silly to take it, so I went into another room; but, all the time I was trying to read, I kept seeing that sixpence. I couldn't get on with my book until I had gone and taken it." A third, a hot-tempered youth of twenty, relates how he was stopped on the verge of homicide by a mental apparition of the consequences. While in the very act of throttling his victim on the floor, he seemed to see, in galloping defile, the constable, the court, the judge in his black cap, and a corpse dangling from the gallows, and then felt himself jerked suddenly back, as if the policeman's hand had already clapped him on the shoulder.

Auditory imagery is less common than visual and far less easy for the child to describe. The plainest instances are those where the words heard inwardly are recollected phrases—insults, perhaps, or instigations, to which the child has actually listened in the past. At times he declares that "something kept

---

<sup>15</sup> See page 136.

telling" him to do what he has done, until at last he felt driven to obey. Asked incautiously who could keep telling him to do such things, he (or, perhaps more frequently, she) mutters shamefacedly "Satan" or "the Devil," doubtless supposing that to be the desired reply. Such expressions, of course, are no more than conventional metaphors, memories of the traditional language of the Bible class, which spring to mind in a penitent or hypocritical mood. But sometimes the child seems genuinely at a loss for a term to describe the mental echoes which he unquestionably experiences, and "the voice" can be proved to be the voice of a comrade, heard in imagination, reiterating some challenge or suggestion. One adolescent had the trick of formulating his own desires to himself mentally in half-articulate language, and was apt to find soundless whispers ringing in his head, like a refrain, such as: "I *must* take it: I *must* take it," or "That was a fine watch: I could get ten bob [shillings] for that watch." A common form of auditory memory is the hearing and rehearsing of obscene or blasphemous words. Curses which the child by chance has overheard keep reverberating in his shocked and impressionable ear. One day he may even catch himself blurting them out in fancy at a person who has ruffled him, and afterwards in some wild spurt of temper he astounds his mother or his teacher by pouring forth the most unexpected imprecations at the most inopportune times.

Touch, smell, taste, and movement are mentioned far less frequently in my records; of all forms of imagery they are the most difficult for the untrained mind to detect and describe. A few children speak of being tantalized by anticipatory sensations of savory food and sweets. Maisie, once more, was a young gourmand who rather reveled in such imaginary flavors, plainly assuming her experiences to be universal. "Oo, can't you smell the pudding still?" she would exclaim, recalling some appetizing cookshop passed an hour or two before. As to tactual imagery, the rare instances that I have noted have been, almost all of them, fancies of affectionate embraces, usually sexual, but sometimes filial. In one case, however, a child who had witnessed a picture drama of a jealous lover strangling his



beloved (apparently a film version of *Othello*) was haunted thereafter by the feeling that his hands were gripping some one's throat, and eventually did half strangle a younger sister.<sup>16</sup> Possibly the common phrases—"my fingers were itching to get at it," "my hands were tingling to box his ears"—empty figures of speech though they usually sound—are repeated by the explanatory offender, because they genuinely characterize the obscure sensations of touch (or, more accurately, the tactile and the motor imagery) which he experienced at the moment.

Mental images such as these are the common property of us all. Yet they seldom goad us into crime. Whence, then, comes the coercive power which they seem to exercise over particular delinquents? In some, the sheer vividness of the imagery seems sufficient to explain its force. In others, all their thoughts have an aggravating tendency to persist until relieved and released by action: in the phrase of the psychologist, such persons are "perseverators." But in most instances, as we shall see later, some deeper reason must be sought, and the vividness or persistence of the obsession has itself to be accounted for by its emotional rather than by its intellectual qualities.<sup>17</sup>

Daydreams and Fantasies.—Where imagery is intense, the child may come to dwell almost entirely in a mental world of his own. Mental pictures can be to him as solid, as lifelike, and as satisfying as the actual sights around him. Many a child thus passes all his vacant moments in a waking dream. In the wilderness of his everyday existence he builds an enchanted fairyland, and the illusion blots out of sight the dreary waste of hunderum matters of fact. His fate is like that of the adventurer in the Arabian tale. When Haakim the Beggar had anointed one eye with the magic salve, all the riches of the earth became visible; but, when he tried the experiment on both eyes, he was struck with sudden blindness. Unless the young dreamer keeps one eye clear and open, healthily fixed upon the outer world, his fancies are likely to blur for him the plainest truths and prin-

---

<sup>16</sup> It is worth noticing that this child and the potential homicide who spoke of feeling the constable's clutch (page 353) were both decidedly psycho-neurotic.

<sup>17</sup> See Chapter XIII.

ciples of common-sense reality. Often the child's fantasies center upon acts prohibited in daily life, and his imagination is tentatively musing on plans for doing some forbidden thing and stratagems for defeating discovery when the deed is done. Sometimes, there may be no thought or intention of putting into actual practice what is simply conjured up as a form of fanciful play. But on some lonely morning when a tempting chance presents itself, his mind is all prepared with an appropriate desire and a suitable device, and almost before he has had time to reflect or resolve, the contemplated crime is accomplished.

It is singular that the vast literature of crime has so completely disregarded the significance of the criminal's reveries and meditations in the intervals of his wrongdoing. Most delinquents—indeed, nearly all at adolescence—are habitual day-dreamers. Hour after hour they moon, unoccupied and idle, making castles in the air. "By degrees the reign of fancy is confirmed; she grows first imperious and in time despotic. Soon fictions begin to operate as facts; false opinions fasten on the mind, and what the heart thinks upon in solitude the hand acts upon as opportunity arrives."<sup>18</sup>

The process is much more than the simple scheming of a future escapade. It is subtle, irrational, and indirect, a game which the mind plays with itself and which somehow turns into an earnest enterprise. Its workings can best be exposed to view by recapitulating an instructive case which I have elsewhere recounted in full.

Nellie Malone<sup>19</sup> was a young domestic servant of sixteen,

---

<sup>18</sup> Samuel Johnson, *Rasselas*, Chap. xlv, "On the Dangerous Prevalence of the Imagination."

<sup>19</sup> Age: 16½. *Home Circumstances*: Father, a foreman in builder's firm, divorced. Mother, now a charwoman, of a severe and worrying disposition, better educated than most of her class, trying hard to muffle up an unsuccessful home life with an outward show of respectability; though helped a little from time to time by other members of the family, she has been obliged to earn her living (about 25s. per week) by cleaning. The home consists of a single room (rent 4s. 6d.); and alike in its tone and in its furniture may best be described as shabbily genteel. One elder brother (aged 22), a shop assistant at a large suburban department store. The family had been better off while the father was living with them and before the brother's marriage.

strong, attractive, over-developed, not obviously nervous or neurotic, but evidently of a repressed and unstable nature. She had repeatedly stolen articles of jewelry—a wedding ring from her mother, a locket and a chain necklace from her mistress. Twice she had spent the whole night out of doors. She was said to lie freely and fantastically, not only about her thefts and wanderings, but also upon trifling points of no perceptible importance. So motiveless were her misdoings, so much pain and discomfort had she undergone for so little pleasure and profit that it was inferred she must be mentally deficient. Accordingly, I was asked to examine her. In tests of practical intelligence, she proved distinctly quicker than the average of her social class; but, in examinations of a more scholastic type, she seemed backward, stupid, and bewildered. A rough probing of her imaginative powers, both auditory and visual, showed that she could call up lifelike pictures before her mind, and could hear “inside her head” unspoken words and phrases, with a rare degree of vividness. Her father, of Irish origin, had been a dishonest workman and a dissipated drinker; he was divorced when Nellie was six. The only other child, a married brother five years older, was at one time a private in a London Scottish regiment and bore a record beyond reproach.

Nellie had been told that her father had died abroad. Young

*Family History:* Father's family said to be “Irish and poor” (no detailed information). Members of mother's family, intelligent, industrious, and self-respecting, all holding responsible positions: two maternal cousins said to be hysterical.

*Physical History and Conditions:* Whooping cough; measles. Puberty at 13.5. Slight astigmatism. Occasional headaches. Height, 160 cm.; weight, 52.0 kg.

*Intelligence and School Attainments:* Mental Age (Binet tests), 13.2; (Reasoning tests), 12.5; (Performance tests), 16.5. Reading, 12.2. Spelling, 11.3. Arithmetic, 11.0. Handwriting, 11.0. Drawing, 11.0. Handwork, 14.0.

*Temperament:* Unstable and repressed. Childish phobias (dread of the dark, of dying, and of blood). Extremely intolerant of cold: yet, after running away, was found asleep in the open under a hedge. Habitual daydreamer with “continued story” (see text). “Father fixation” with transference to brother; antagonism to mother, with transference to head mistress at school, and later to employer; “anti-authority complex.”

as she was, however, she had at the time suspected her mother of evasions. Often she wondered what had actually become of him and tried to conceive what he might be doing and how he looked. She brooded, and in her babyish reveries started a sort of continued story which she told and retold herself whenever her mind was left without employment—in bed just before dropping off to sleep, during her solitary walks to school and back again, and later during her wanderings from home. The tale was made up almost entirely of visualized events. It was a scroll of colored paintings of people, places, and episodes, interspersed with fragmentary scraps of childish dialogue. Of the particulars, much had been culled, as the fable gradually took shape, from story books, from film dramas, and from penny novelettes depicting the gay and gorgeous life of the high society among whom the girl longed to move.

In its final form, her self-told story consisted of a cycle of daydreams. In these she usually figured herself as encountering, in a wood not far from her home, a handsome and affable stranger. He was young, and wore her brother's Scottish uniform; and presently revealed himself as no less a personage than the Prince of Wales, rambling alone incognito. He tells her that her father is "descended from the Irish kings"; that her mother is not her real mother; and that she herself is "a lady in her own right": all the phrases used are dim reminiscences of her father's gossip about his early ancestors and of her mother's sentimental pinings for the days when the family was better off. In a later interlude the stranger takes her to a Highland castle, a blend of Holyrood and Balmoral, situated, incongruously enough, above the lakes of Killarney—buildings and landscapes all mentally pieced together from old engravings on the walls at home. He offers her his hand in marriage, and bestows on her a ring set with pearls and a heart-shaped locket hanging from a chain of gold as visible tokens of his love. Eventually, he says that she must go back to her servile work and for nine months more drudge like Cinderella in the scullery, though all the while a princess in disguise.

The connection of these romantic reveries with the girl's overt misconduct must be evident to all. To begin with, even as

a child she became a moody, absent-minded dreamer, always losing touch with the hard world of practical reality and moral values and moving in a realm of moonshine. She had grown to cherish odd and extravagant desires, all out of keeping with her true situation. Nor was any great exercise of sophistry needed for her illogical mind to pretend and persuade itself that the things she seized were rightly hers, and that, instead of her own actions being unfair to her mother or her mistress, it was her mother and her mistress who had been unjust to her. She would deck herself out in the stolen jewelry and, gazing hypnotically at her image in the mirror, would dream she had just received them from her betrothed. Sometimes the jewelry would be replaced. Sometimes it was not, and then she could always escape the pricks of conscience by launching once more into her fairy tale and floating away in a golden mist.<sup>20</sup>

### *Treatment*

With children who are brilliantly equipped in one direction only, whether they exploit their gift for lawless escapades or fritter it away in games and daydreams, the difficulty is that it is seldom discovered until too late. Before ever its presence is suspected, it has got petrified in some worthless habit, and there it remains, as inaccessible and useless as a chip of shining quartz in a muddy lump of flint.

When the child's specific bent is noted early enough, the general course of treatment will be obvious. It is to take his individual talent, strengthened as it usually is by the enthusiasm that goes hand in hand with it, and turn it from a tool for illicit pranks into an implement for useful work. In school the utmost should be made of such capacities. At present the teacher is apt to look for, and to find, special deficiencies rather

---

<sup>20</sup> I have analyzed the case at some length elsewhere (*Journ. Exp. Ped.*, VI, 1921, i-v, "The Dreams and Day-dreams of a Delinquent Girl"). With this girl the treatment, in the main, followed regular psycho-analytic lines. As soon as she had thus been led to discover the real aim and origin of her caprices, the main delinquency—namely, pilfering—disappeared altogether. In other respects the girl's subsequent conduct gave cause from time to time for much anxiety. But, since her marriage, she seems to have settled finally down to a normal and a reputable life.



than special powers, the negative endowment rather than the positive. Even in the most backward and the most defective, we should still grope not for the causes of deficiency and backwardness alone, but also for latent aptitudes and interests, for rudiments of taste or skill, such as may offer promising material for appropriate cultivation and in some measure serve to counteract whatever is holding him down. As it is, the usual practice is to grade the child down for his worst subject instead of advancing him for his best, so sapping instead of buttressing his sense of self-respect. In many schools promotion by particular subjects rather than by general grades is always a feasible plan. In others, special courses on special topics—in the domestic and practical arts, in the various commercial, industrial, and agricultural branches—should afford some scope for adapting instruction to individual keenness and equipment. The child with dexterous fingers should have full advantage of classes in drawing, painting, woodwork, metal work, or the like. The child with a linguistic gift beyond the average should be encouraged in reading and in composition both oral and written—never kept back just because, as so often happens, his arithmetic is weak. The imaginative child may be trained upon æsthetic lines, in artistic appreciation as much as in artistic execution: indeed, too much execution—writing fanciful poems, strumming sentimental tunes—is apt to intensify rather than regulate the emotional elements of his nature, whereas to imbue him with a right appreciation of the best poetry, of the best music, of the best works of art, may bring his feelings and his fancy under firmer and more delicate control.

The daydreamer needs more tactful handling. From monotonous or mechanical tasks that do nothing but foster abstraction and fantasy he should be lifted entirely away; his attention should be kept continuously occupied, continuously active. With him what is most likely to be effectual is not a roughshod attempt to suppress or crush out his sentimental leanings, but mild, sympathetic efforts to link up the topics of his reveries with the sharp realities of the outer world. He must be brought always into conscious touch with other persons and with actual things. He should have from time to time a taste of real vic-

tory over genuine difficulties, and his dreams must be rendered as objective as can be. Much may be done by supplying his meditative moods with better substance to work upon, chiefly, of course, by the aid of those externalized daydreams of the highest intellectual minds—pictures, poetry, creative literature, and the drama whether of the cinema or of the stage. By placing before him, readymade, the best specimens of each, the whole process of imagination may become, not an accessory to crime, but an instrument of culture and refinement.

### Children's Lies

Of the special capacities we have been discussing, the two last—the gift of a lively imagination and the possession of a ready tongue—together make up the special intellectual outfit of the liar. A lie is not of necessity a crime; yet lies are regularly employed to assist, and almost invariably invoked to conceal, crimes of whatever description; and, upon occasion, a lie, from its very content, may prove a most dangerous and dastardly offense in itself.

The telling of untruths is a frequent reproach, not only against habitual delinquents, but also against children not otherwise unprincipled. "One of my pupils is an incorrigible storyteller. What am I to do with him?" The appeal is a common one, and the first reply is another question: What kind of stories does he tell? Children's falsehoods are of many forms, and the treatment differs with the type. Casuists have diligently discriminated various grades of lying by determining the measure of reprehensibility that ought to be attached to each. Here it is not with moral but with psychological distinctions that we have to do. Classed by their underlying causes, we may recognize at least six or seven varieties, all broadly distinguishable, yet running imperceptibly the one into the other.

### *Types of Lies*

1. There is, first, what may be named the *playful lie*. Tiny children are full of make-believe: "let's pretend" is their favorite game, and much of their amusement owes its charm to a passing or a partial self-deception. A child of five comes to

school solemnly averring that she now has a new companion, a baby girl to play with, and her teacher is presently shocked to hear that there was not a grain of truth in the statement. To charge the child straightaway with lying may be to make a gratuitous sin out of an innocent pastime; probably in a day or two the child will be setting a chair for the invisible friend or chattering away to some superannuated doll whom her fancy has erected into a new-born babe. So, too, when the child announces that he has just seen "a funny man with three noses," "a kitten with pink fur," "bananas growing on the lamp-post," he no more means to deceive than if he had freakishly drawn these Munchausen wonders with a pencil instead of proclaiming them with a prattling tongue. The new discovery that truth and falsity are different is often marked by an outpour of such figments. The child has just learnt that he has the magic power to conceive and publish fancies that have no counterpart in fact, and his first deliberate fabrication yields him an exhilarating sense of frolic. At an older age the same motive repeats itself in a more sophisticated form; spurious lies are related as innocent tricks or as part of some practical joke; and perhaps almost immediately confessed. Such fictions are no more lies than are the creations of the humorist, the novelist, or the poet. They are purely a mode of play.

2. There is, secondly, the *lie of confusion*. Children are exceedingly suggestible. They see little disparity between a fact that is real and a fancy that is vivid. What they have genuinely witnessed gets easily jumbled in their minds with what they have simply imagined or what they have merely been told. Ask them a question, and should their memory, their knowledge, or their power of expression be at fault, they instantly improvise what they feel to be a fit reply or perhaps put a gloss on some authentic experience, all without the least intent to deceive. Convict the little muddler of untruthfulness, and he feels a sort of retrospective guilt at once and grows more rather than less bewildered. All such misstatements are to be dealt with for what they really are—accidental errors or illusions and not downright untruths.

3. The casuists in their classifications, as Dr. Johnson noted long ago, "have generally omitted that kind of lie which is the most common, and, perhaps, not the least mischievous: which," he adds, "since moralists have not given it a name, I shall distinguish as the lie of vanity."<sup>21</sup> Lies designed to attract self-notice develop easily out of childish inventions of the two foregoing types. In general they are exaggerations rather than pure falsehoods; but the embroidery is often thicker and richer than the bare tissue of truth that it decorates. Such lies may range all the way from the empty but straightforward boasting of the braggart boy, to the subtler and more highly colored romances of the self-centered, semi-neurotic, sensation-mongering girl; they merge, at an older stage still, into the baseless complaints of persecution or illness made by the truly hysterical. They express wishes, not perceptions, and are frequently the impulsive utterance of fancies that have long been dwelt upon in daydreams. The most morbid form consists in false self-accusations, in the bogus confession of imaginary misdeeds that have been neither performed nor intended.

4. Graver still are lies where the object is not to extol or magnify oneself, but to belittle, annoy, or even endanger another—the lie of malevolence and revenge. Where a serious charge is falsely laid, the outcome may be tragical. Sometimes the persons so traduced are the very ones who have been nearest and dearest to the child. Sometimes, too, the statement—not infrequently an accusation of a sexual assault—seems so foreign to the thoughts of a healthy child, and the childish denouncer herself seems so guileless, plausible, and innocent, that credence is given at once without inquiry. As a rule, after careful exploration, some analogous experience in the past, hidden or half-forgotten, can generally be brought to light, and may be shown to have provided a basis for the calumny, though the doings or sayings recollected have been fastened, for private and malignant motives, upon a person entirely guiltless.

5. In most of the foregoing examples, harmless and heinous alike, the child is often self-deceived as well as deceiving. In the excusive or exculpatory lie, the child is acutely conscious of

---

<sup>21</sup> *The Adventurer*, April 28, 1753.

deception. The purpose is usually plain. There is something done or something left undone for which the dissembler is anticipating blame. Such lies, in the main, are not constructive fictions but negative disavowals or denials. Most thieves lie to cover up their wrongdoings, and nearly every offender will perjure himself over the offenses which with him are most habitual or for which he has been constantly condemned. But even among the honest and obedient, there are few who have not upon occasion proffered a false explanation for being late, for forgetting an errand, or for breaking a cherished vase.

A lapse of this kind is not so unnatural as may be thought. Secretiveness is the first and strongest tendency that springs from awakened fear: and during childhood fear is universal. The most scrupulous, taken by surprise, may be frightened into a hasty disclaimer, while the cowed and timorous weakling who spends most of his time at home dodging blows and evading reproaches develops, as a permanent means of self-preservation, the defensive attitude of disowning whatever he may happen to have done.

6. In the more hardened and unprincipled, the positive line is exploited no longer as a fear-stricken excuse, but as an audacious pretext—no longer to shirk punishment for what is past, but to gain profit or pleasure in the near future. Cheating at games and at lessons is the commonest and perhaps the least objectionable form of what may be termed the selfish lie. Where the lie is deliberately manufactured as an instrument to some further offense, the practice becomes more reprehensible. "Mother says will you please lend her a penny for the gas meter," is a favorite ruse for fraudulently obtaining a coin. The begging tales of the young delinquent are, as we have noted, at times most elaborately woven, and the wiles of the juvenile swindler are often miracles of ingenuity. One curious feature, making it harder than ever to detect the lie and to visit justice upon the liar, is to be found in a result well recognized, namely, that the habitual impostor may lose all sense that he is stimulating and grow to believe implicitly in the truth of his inventions. Frequently he is himself his own most perfect dupe.



7. Lies of loyalty and convention are not uncommon among older children. In the elementary school the spirit of a sportsmanlike comradeship which prevents one child betraying another to an elder is not so general as in the public school, and everywhere it seems rarer among girls than among boys and older youths. To keep up a joint or comploted lie is much easier for male conspirators than for female. To girlish lips it is the lie courteous rather than the lie of allegiance that comes with greatest readiness. In an effort of tact and flattery, to avoid wounding the feelings of her questioner, a girl may willingly stretch the truth. Among girls, too, modesty, or a notion of what the listener may conceive as modesty, leads often to demure and decorous prevarication. And upon almost any topic, and with almost any child, "I don't know," may be used, with a mental reservation, to insinuate "I don't think you have the smallest right to ask."

Conventions differ greatly in different social classes, and just as the poorer classes are sometimes shocked by what seem to them the shams and hypocrisies of their betters, so the so-called better classes regard as indefensible untruths and shameless falsehoods what are no more than traditional tactics—tactics quite justifiable in the eyes of the humble diplomats themselves, when they feel themselves confronted by an inquisitive stranger from an alien social sphere. Such simple folk are apprehensive lest if they weakly surrender their private confidences, the superior intelligence of the superior person may cunningly catch them at an unfair disadvantage in the ensuing argument, and so an immediate denial or misstatement is held to be a licensed mode of self-defense against a dangerous astuteness. In homes like these the suspicion and the wariness of the parent are communicated to the child, and those Spartan families still survive in which the sin is thought to consist not in the telling of lies, but in the telling of them with such futile clumsiness that they are afterwards found out.

Lying, then, takes countless shapes and has a thousand different motives. It may be employed to compensate for almost any form of intellectual weakness. It may be inspired by almost any emotion—by fear more than any other, but also by greed,

anger, self-display, submissiveness, and even by mistaken loyalty and affection.

### *Pathological Lying*

Among the many quasi-criminal "manias," what is variously known as mythomania, pseudo-mania, or (more pretentiously) *pseudologia phantastica*, has a long literature of its own. The best name is the plainest name, and a simple term like "abnormal-lying" is to be preferred to Greco-Latin technicalities in that it professes to be no more than a purely descriptive phrase. Abnormal, morbid, or pathological lying is simply lying that is wholly disproportionate to any discernible end in view. In character it is usually complex, and in origin seemingly motiveless, impulsive rather than planned, and so repeated or sustained in duration as sometimes to extend over many months or years. From what may be termed normal lying it thus differs in degree rather than in quality, and so may belong to almost any one of the classes enumerated above.<sup>22</sup>

---

<sup>22</sup> The medical and criminological importance of these cases was first emphasized by A. Delbrück, to whom the term *pseudologia phantastica* is due (*Die Pathologischen Lügen*, 1891). Many foreign writers have since investigated the condition. The cases described by continental writers confusingly include many where the so-called "pathological lying" is not the primary symptom, and a few, indeed, where it is not strictly to be denominated lying at all—cases, for example, of borderline insanity where the falsehoods are a logical outcome of persecutory delusions.

It should be added that, even during early years, apparent storytelling may, in rare instances, spring from delusions or hallucinations, such as in turn originate from a definite disease, whether past or impending—for example, the febrile illnesses of childhood like measles, scarlet fever, or meningitis. Dr. Guthrie tells of a nervous school-fellow of his who came one morning with a baseless tale of burglary at home and related how two men had crept into the house at night and how his father had shot them on the lawn; the boy was expelled for lying and a few days later died of brain fever (*Functional Nervous Disorders in Childhood*, p. 99). The hallucinatory and delusional states characteristic of epileptics, of drug habitués, and of the insane are rare among young people, at any rate before the adolescent stage, and do not give rise to pathological lying in the sense in which the term is here employed. The monograph on *Pathological Lying, Accusation, and Swindling*, by W. and Mary T. Healy (*Criminal Science Monographs*, No. 1, 1915), contain a résumé of earlier researches, and gives detailed studies of 27 cases investigated at first hand. It is a book to be read by all who are concerned with this subject.

The disproportion between means and motive—between the extent, elaboration, frequency, and ulterior consequences of the lie, on the one hand, and the purpose which apparently inspires it, on the other—may be due to a variety of exceptional conditions. Of these, the most essential are the two specific abilities already discussed, namely, an over-active imagination and an overflowing facility in the use of words. These two related traits can be demonstrated with ease by simple psychological tests. In a test, for example, of ability in free written composition, the pathological liar is singularly in advance of the ordinary juvenile delinquent. His intelligence is usually average or more than average, seldom definitely defective. His powers of observation and of memory, as other tests will show, are also nearly normal, though, indeed, if the exercises are indifferently administered or examined, his performances may at times erroneously convey that he is by nature unobservant and forgetful. There is, however, one laboratory test which reveals, almost as clearly as his behavior in the outside world, the special proclivities of the morbid liar. This is the so-called *Aussage* test, a mode of measuring a man's precision in testimony and report.<sup>23</sup> The examinee is shown a suitable picture and is required to describe, either directly from the picture itself or more usually from memory, and both spontaneously and in reply to detailed questions, all that he has seen. His responses are marked for their accuracy, and the marks compared with known and standardized results. Nearly always the pathological liar at once exhibits himself as a wholly untrustworthy reporter. He will weakly accept every suggestion put to him or he will volunteer inventions of his own, and throughout he will make astonishingly little effort to discriminate between what might plausibly have been present in the picture and what he has actually observed there.<sup>24</sup>

Of this group of delinquents, then, these are the more striking

---

<sup>23</sup> A test first employed by Binet in France and later by Stern and his pupils in Germany. See, for methods and results, G. M. Whipple, *Manual of Mental and Physical Tests*, ii, pp. 17-42 (Test 32).

<sup>24</sup> Healy, using his own form of the test, also notes that "not one case shows the sturdily honest type of response that is frequently met with in testing other delinquents" (*op. cit.* p. 253).

traits. But besides these intellectual qualities—the vivid imagery, the ready speech, the lack of a faithful recollection—emotional peculiarities, vaguer and more variable, are generally to be found as well. In the background there may be a want of temperamental balance amounting often to a marked constitutional excitability. Sometimes there are definite neurotic complications, like hysteria; less frequently, more serious nervous conditions, such as chorea, epilepsy, and mild psychopathic derangements. The family history is generally of a piece with the emotional characteristics of the child: in many of my cases two or three of the child's near relatives were reported to be neurotic or insane.

As regards environment, it is instructive to note how, time after time, in the home life of the children, there prove to have been dislocations of normal family relationship, sometimes downright immorality, nearly always a weakness of parental discipline, and quite frequently another member in the household with an open disregard for truth. In the habit of fantastic lying there lurks a singular contagion, and when two or more liars belong to the same family, the similarity may be wrongly fastened upon as a proof of inheritance.

With these domestic factors the actual precipitating cause of the outbreak is commonly linked. At times the development of mendacious tendencies can be dated from some upsetting personal experience, both the upset and the experience having been repressed, or at least concealed, by the child herself. As a general rule, her nature is to brood, to nurse a grievance, to live an inner life of self-told fantasy, and her complicated fabrications are the upshot of some secret wish of a suppressed or a compensatory kind. Not infrequently, a further search will bring to light additional delinquencies in her own past history—stealing, truancy, and, most commonly, flight from home. The running away itself is part of the deep disinclination to face reality and to stand up to consequences, and may constitute a rash attempt to escape from some tight quandary in which the child's own lies have fixed her. Bad sex habits, particularly masturbation, are common in such children.

The pathological liar is nearly always a girl, and frequently

pubescent.<sup>25</sup> The cases that have obtained most notice are those of false accusation, sometimes against strangers, most frequently against near relatives, and occasionally against the liar herself. The sender of anonymous letters, usually more or less indecent, is a common instance of the general type. At times the falsehood is kept up by actions rather than by words and becomes more of a hoax than a lie. Of these acted frauds the history of witchcraft and of spiritualistic prodigies furnishes the best examples. Where the family circle is disturbed by weird cries and mystic messages, where uncanny raps are suddenly heard, missiles hurled, windows smashed, tables overturned in the dark—all seemingly apart from human intervention—the simple and usual agent is an hysterical child or young woman, and a safe precept has been formulated for such cases: *Ne cherchez pas la femme, mais le tendron.*<sup>26</sup>

From my own records I select the following case, not only because it best exemplifies the general type, but also because, in many minor points, it is full of curious interest for the student of childish misdemeanors.

One morning in 1917, Mr. Naylor, a highly respected foreman holding a responsible position in a large electric light company, arrived at his work and found himself suddenly confronted by two furious acquaintances waiting for him at the gate. "Look here, Naylor," cried the first, "how long have you been carrying on with my wife?" "And I want to know the same," said the other. "Look at this." They showed him a couple of letters scrawled in filthy language upon equally filthy sheets, addressed to each of them by name at the "Lectric Light Shop, Blank Street, Richmond." The first letter began: "Mr. Thomas. This is to tell you your Mrs. Thomas came to our house on Saturday. That pig Naylor took her up into the bedroom; and then he . . ." The remainder contained a minute account of certain repulsive and perverted practices; and was subscribed "May Naylor." The second letter was to

---

<sup>25</sup> In Healy's cases there were five males among eight cases of borderline mentality, and among the nineteen whose mentality was normal, one male only.

<sup>26</sup> "Look, not for the woman in the case, but for the damsel."



much the same effect except that it trailed off into a string of foul words, ending "Amen amen and bow-wow-wow to you," with a little dog scratched in underneath.<sup>27</sup>

While Mr. Naylor was protesting that he did not even know that either of the men was married, a third workman came up with an identical complaint. Now the thing was manifestly something more than a practical joke in unwholesome taste, for Mr. Naylor had himself been receiving from the postman almost daily an interminable correspondence, scribbled in the same illiterate hand on torn and crumpled flour bags and signed with the same name, which was that of his only daughter. These letters contained a similar string of baseless accusations. And two days after the foregoing incident, a long document was sent to the vicar of the parish and a copy to the head of Mr. Naylor's firm, urging each of them to "drive this lothsum man from London." Accordingly, after consultation with his friends, Mr. Naylor put the whole affair in the hands of a detective.

The detective began with inquiries at the school. May appeared a neat, happy, inoffensive child of nine. Both at the day school and at the Sunday school (which she attended with punctual regularity) she bore the character of a well-behaved and even pious pupil: "the last person in the class," said her class mistress, "who would ever use bad language." She was a careful speller and wrote a tidy printed hand,<sup>28</sup> the very opposite of the dirty scrawls her father had received. Her mother, however, an ill-educated woman of bad repute, had been divorced two years before, when the father returned from the war; and the detective at length decided that the letters must have been composed by this woman out of spite. His inference seemed confirmed by a small circumstance the father now recalled—

---

<sup>27</sup> Compare Figure 17—a facsimile of a letter sent to the father. The phraseology of this letter is decency itself compared with that of the majority.

<sup>28</sup> See Figure 18. The "print-script" of this second note (written two days after the foregoing) was taught in all the classes of the senior department: the cursive hand, used in Figure 17, had been taught in the infants' department—at the age, therefore, at which the girl's trouble first started and at which she heard the language and the ideas displayed.

to me [ ] will you old come  
I have given you some peace  
and now I am going to  
start to again you here  
I am going to tell you matter  
munday I am going to tell  
here lot of his about you and  
rotten cow wife and I will  
put that dam rod on the  
fire or cut the winder and  
you just wait when I am  
grown up I will be over  
you old swore and devil  
I will never call you bastard  
again

Amen

o o o o  
Bow wow wow  
to ~~you~~ you

Mary [NAYLOR]

not [LOMAX]

FIG. 17. FACSIMILE OF LETTER BY "MAY NAYLOR"  
One-half original size

Dear Sir,

I thank you very much for the nice needle work box you have given me. I feel very proud of it.

I am trying hard to be a good girl. Will you please give my love to the lady you had with you on Sunday. And I thank you very much for the kindness you have shown me, and I am looking forward to seeing you again. Will you please excuse this short note, but will write again.

Your affectionate friend  
May [LOMAX]

FIG. 18. FACSIMILE OF LETTER BY "MAY LOMAX"  
Original size

namely, that a rare and coarse expression recurring in several of the letters had been always on the lips of his former wife.

Nevertheless, May's stepmother (for the father had remarried) gave it as her conviction that the letters were really the handiwork of May herself, though possibly inspired or dictated by her divorced mother's malevolent mind. Other children had once seen the girl talking at the school gates to a gesticulating stranger in bonnet and shawl—a figure answering in many points to the description drawn of her mother. But though May was closely shadowed, nobody ever saw her meeting the woman again or caught her writing letters, buying stamps, or slipping envelopes into the pillar box. At last, owing to the stir created among her schoolfellows, the head mistress applied for the girl to be excluded until the mystery should be cleared up. I visited the school, and the child was brought forward for interview.<sup>29</sup>

To me, as to every one else, she seemed a serene, sweet-tempered, blissfully innocent child, a little sentimental, and of a

---

<sup>29</sup> *Age:* 9½. *Home Circumstances:* Father, a foreman and superintendent of mains in an electric light company (£4 10s. per week). Step-mother, quiet, not strong in health, and barely of average intelligence. One half brother, aged 11 months. Three rooms, clean and well-furnished (rent 12s. per week).

*Family History:* Father, intelligent, but neurotic, excitable, and garrulous. Mother (divorced), alcoholic: repeated sexual misconduct. Father's family, all said to be intelligent, highly respectable, and in comfortable circumstances. Maternal grandfather, formerly a coachman to a Yorkshire country family: excitable, a heavy drinker, and obtaining only casual work. Maternal aunt (housekeeper for grandfather), dull, quiet, and well disposed towards May. Maternal uncle (lodging with grandfather) a postman, highly intelligent, an enthusiast for social and religious work: has a better understanding of May than any other member of the group.

*Physical History and Condition:* Measles, diphtheria: incontinence (day and night) till 8. Somewhat anæmic; frequent headaches; slight astigmatism; masturbation. Mentions, with a smile, occasional stabbing pains in her head and side, and similar small complaints, probably psycho-genic: apart from the slight defects mentioned, no genuine physical trouble. Height, 121.6 cm.; weight, 23.5 kg.

*Intelligence and School Attainments:* Mental age, 10.8 (mental ratio, 114). Reading, 11.0. Spelling, 10.5. Arithmetic, 9.5. Handwriting, 10.5. Composition, 11.0. Drawing, 9.0. In tests of special abilities, appears imaginative and suggestible, with a memory unusually good.

distinctly neurotic strain. She was moderately clever, her mental age being a year above her actual age. She possessed great facility in English composition, strong powers of visual imagination, and a wide and refined vocabulary. Her tastes and ways were dainty, indeed almost demure. She told me, I remember, that her favorite flower was the lily of the valley; it was "so white and pure and clean"—the exact antithesis of the writings I had just inspected. Her teachers and all who knew her protested that it was "a shame even to think of the child in connection with such wickedness."

I made no mention of the letters and put no questions to her about them, for I was at once convinced that she was the sole and secret author. My belief was corroborated when, after a special speed test, I found that she had committed several of the same mistakes in spelling that were sprinkled so thickly all over the disputed documents. For some months she came to see me almost weekly. She proved highly suggestible and went easily into a semi-hypnotic state. In these dreamy moods she would chatter with freedom of her own past life. She recollected in much detail how, three or four years ago, strange men had visited her mother in the nighttime, and it was evident that more than once she had witnessed scenes of a kind no uninitiated child could guess at or invent. During all these weeks, despite the strictest watch at home, the surreptitious writing still continued. It was a veritable effusion of ink and gall. New scandals were trumped up; alleged witnesses were named. Letter after letter, card after card, arrived by post, accusing the father now of theft, now of heartless cruelty, and ultimately of an incestuous assault upon the girl herself. Twice they announced, without a shred of truth, that May herself was stealing; once, that she had taken to immoral practices upon Wimbledon Common; and on three occasions they all but led to criminal proceedings against the father.

One evening I showed her an unopened envelope sent on to me from her home. In her trancelike condition she could recite, word for word, every item that the letter contained.

---

*Temperament:* Unstable, sensitive, repressed. Mild hysterical tendencies, with a marked degree of mental dissociation (see text).



It had been written, she explained, in the lavatory, stowed away in an undergarment, and stamped and taken to the post by a triumph of maneuvering. Next week, in her waking state, she repudiated the whole thing, protesting with bitter tears that she knew nothing of it, utterly oblivious that she had already confessed all that the last communication stated and how it had been composed. Now, too, in her open correspondence she began systematically to sign herself "May Lomax"—taking the maiden name of her mother;<sup>30</sup> and appealed to other children never to address her by her father's surname. There were thus, by a sort of spiritual split, two minds in the same body. Behind the visible May was an invisible May, and their natures were exactly opposed. The one was frank, the other cunning; the one was affectionate, the other mean; the one was fastidiously correct and scrupulously pure, the other coarse, revengeful, and foul-mouthed. The child was, in truth, the nearest approach that I have ever known, at an age so young, to a dual personality. She seemed the living counterpart, in feminine miniature, of Dr. Jekyll and Mr. Hyde.

How far her strange oblivion was due to a covert wish to forget, and how far it rested on a sincere inability to remember, it would have been fruitless to inquire. But the proper course seemed plain. It was, by gradually talking her (as it were) out of her hypnoidal states instead of rousing her abruptly, to try to bring her two opposite moods into contact and so blend the separated halves of her twin life into one.

In the course of all these discussions, the hidden roots of the child's abnormal conduct floated gradually to the surface. Her own mother, it would seem, she had always loved so much that she could never believe anything evil about her; the memories seemed like memories of a dream too frightful to be true, and she had shut them away in some back cupboard of her mind. Her father's remarriage she had, in secret, fiercely resented, and the transfer of his affection from herself and from her

---

<sup>30</sup> This name, as a matter of fact, had previously been used, in part to distinguish her from another girl called Naylor attending the same school and in part from an early misunderstanding as to the child's real surname—an error produced, perhaps with a purpose, by the mother when she first brought the child to school.

mother to the new wife had goaded her to jealous fury. These heated feelings she had tried to extinguish—with entire success, had it not been for what she called her wicked moods.

Why her revenge took a shape so singular was explicable when I knew more of the family and her history. Her father himself was a prolific correspondent; his foolscap communications to me fill a large box file. Plainly, he pinned great faith to the written word, and during the war, when he left home for the second time, he had insisted on a weekly note from his little daughter. If she had done anything wrong during the past seven days, she had to write and tell him, and he would send back a loving letter of advice. Some of her later notes contained small self-accusations that were wholly untrue, but they served to provoke an answer full of tenderness. Once or twice even, her distressed father, after receiving them, had traveled home, petted her, promised her toys and presents, if only she would be good. But so long as her notes reported immaculate behavior, he saw no reason for a prompt reply and merely sent through the stepmother a greeting at second-hand. May's penetrating shrewdness soon taught her that in this power of correspondence she was wielding a formidable weapon, an effective instrument for wresting her father's attention back upon herself and for repaying his neglect with blows more cruel than any other she could use. The letters became almost a diary of her "wicked moods," and the periodic outflow seemed to bring a consolatory relief to all the agitating memories that kept gushing up in her mind. Most of the earlier notes the stepmother intercepted and forbore even to mention them to the father. When at last the father returned for good the epistolary habit sank into abeyance until the baby brother was born. Then May's jealousy returned with an overmastering force; her worst humors revived. Not for a moment could the father credit his own daughter with compositions so outrageous, and the stepmother, reproached with a prejudice against the child, kept her notions to herself. Very foolishly, however, the wounded man displayed his grief before the girl, even ejaculating one day in her hearing: "Good Heavens! Some fine morning they'll be sending letters like this to the works." And it was

from exclamations such as these that she reaped much of her encouragement and inspiration.

As, little by little, May unfolded the autobiography of her soul, the bad moods and evil impulses began to diminish and at length to disappear. But before this final stage was reached, the detective had discovered that the first wife had long ago left England for Australia. The news by accident came to May's ears. She had one more "bad day"; and ran to me, announcing that she was afraid she would murder the baby or her father would murder her if she stayed any longer in her own home. She begged that her maternal grandfather, an old, drunken, poverty-stricken coachman who thrashed her without mercy, should adopt her and that she should take his name. In the end, this was the course agreed upon. May left the comfortable home of Mr. Naylor and lived instead in a two-roomed tenement with Mr. Lomax in a slum. A little further treatment made it possible to break down the barricade between her two contending personalities and, by putting each, as it were, into communication with the other, to reunite and synthesize them in a single and harmonious whole. When this was done, May Lomax ceased to be quite as prim and proper as she had previously seemed, but May Naylor, the jealous and vindictive letter writer, vanished like a ghost at daybreak, and the scurrilous correspondence came at last to an end.

### *Treatment*

The problem of childish lying is of such importance, alike in the training of the ordinary boy or girl and in the handling of the young delinquent, that I may be pardoned for devoting space to a few primary but neglected principles.

1. *Differential Treatment*.—In dealing with a particular lie uttered by a particular child, the first step is to ascertain whether that lie is a single isolated lapse or one of a numerous series; if the latter, it becomes important to inquire what type of lies he generally tells and what may be their animating motive. One lie does not make a liar. All children tell occasional untruths, and many have fits and periods of dissembling. The sense of systematic truthfulness comes late.

Different forms of falsehood call for very different remedies. As a rule, what has to be attacked is not the lying, but some deeper trouble in the background, and this may vary from child to child. To treat the lie as a simple, self-subsistent mode of perversity, to scold and castigate the liar each time he is found out, will seldom purge him of his tricks; it will only teach him a sharper cunning for the future. Accordingly, the basis of every lie must be explored before the lie itself is dealt with, and where the lies are so extravagant as to seem pathological, the analysis may be protracted. In particular it is always well to hunt out any special weakness or bad habit, any darker fault or vice, which the lie may be exploited to conceal.

2. *Avoid Provocative Occasions.*—Both the incipient and the habitual liar must be protected from situations setting too great a tax on their intelligence or candor. A regular thief who has been as regularly punished for his thefts should never be questioned as the sole source of information and thus presented with a gratuitous chance to tell yet another untruth. So far as possible, all lies must be immediately detected; the first exculpatory falsehood that a child happens to palm off with success is often the starting point of a long series of deceptions, each cooler and more calculated than the last. Never let the child see you are uncertain whether he is speaking the truth or not. Rather throw the uncertainty to him; let the blusterer feel puzzled whether you may not be laughing at him in your heart for a bluff so silly and transparent. Equip yourself beforehand with conclusive evidence; never challenge him on the strength of pure suspicion, trusting, from a downcast head, a stammer, or a blush, a shifting eye, or a brazen stare, to detect his consciousness of guilt. Should you, indeed, be doubtful, allow him the doubt's benefit, accepting what he says with punctilious civility, just as you would accept the statements of an equal. Treat the deceiver as though he were trustworthy and you may shame him out of his deceit. Grant him, therefore, the fullest credit for every particle of fact his fabrications may contain, with the dictum of the practiced charlatan always in mind:

That every cheat's inspired, and every lie  
 Quick with a germ of truth.<sup>31</sup>

The worst approach is the weak and wavering one so generally adopted. The hearer first feels and expresses a misgiving; he then puts further questions, which, naturally enough, are answered only with renewed and more sophisticated lies; at last he has to give up the cross-examination and gulp down the doubted word; a few days later, having chanced upon some independent confutation, he returns to the story-teller and now denounces him as a barefaced fraud. What could be more devastating to the questioner's prestige? He has shown, first, that he is incapable of recognizing a falsehood at first sight; secondly, that he can be persuaded to swallow a succession of lies, if only the lies are good ones and the liar stubbornly persistent; and, thirdly, that what betrays the liar, if ever he is betrayed, is not the hearer's perspicacity, but some unlikely accident of outside evidence, such as usually comes late when the heat of the crisis is over and quite conceivably may never come at all.

3. Confession.—No punishment should follow a confession. To extort an admission publicly, in the face of the whole class or in front of the injured party, is to make that admission insuperably hard and a shuffle irresistibly easy. As a means of eliciting facts, the practice of urging a clean breast should be abandoned.

It is amazing how almost every teacher and parent expect the most hardened little sinners still to tell the truth about their sins—as if a lie were the last and worst offense the child could fall to instead of the easiest and the first. Should a child be bad enough to steal, he is almost certain to be bad enough to equivocate about his theft, when taxed with it outright. And once he has begun to delude you, a barrier is set up and any free and friendly discussion about his general situation becomes all but impossible. In the rare case of a frank or voluntary avowal, the outlook is most hopeful. With the remainder, it should be almost an unbroken rule never to begin with a direct

---

<sup>31</sup> Browning, *Dramatis Persona*, "Mr. Sludge, The Medium," I, 124.



interrogation—"Did you or did you not take that sixpence?" For thus asking the child to own to his undisclosed misdeeds, there is but one justification; it might be put to the culprit in such terms as these, though it is better expressed by an attitude than by an argument: "You and I have been friends hitherto. We can remain friends no longer if you are conscious of misleading me and I am conscious of mistrusting you. Let us each be unreserved and open, so that we may start afresh on the same happy basis as before. I am asking you to tell the truth, not because I am too lazy or too stupid to get decisive proof myself, much less am I asking you to bear witness against yourself that I may then reproach and punish you. My only motive is that I may understand you better. Friends have no secrets from each other—not even shameful ones. And if everybody lied to everybody else, society would be impossible and all intimacy poisoned." At times, in seeking a confidence it is wise to disarm a possible dread beforehand by saying, plainly and explicitly: "You need not answer if you do not wish; or if you prefer, I will promise never to tell your mother" (or "your teacher"—"your schoolfellows," or whoever may be feared) "without your express permission first of all."

The utmost discretion must be used as to when to expect an acknowledgment of guilt. Demand it too soon, and the agitated conscience, all eager to disown the misdeed even to itself, may be hustled into a lie it never for one moment meant to tell. Defer it too long, and the child may feel that, after all, the blame has not been brought home to him, and in reply to some more hasty questioner, he may have committed himself to a denial already and may now think it too late to retract.

4. The Encouragement of Confidence.—With young children truthfulness is at first no more than loyalty to persons, a return of gratitude to those who are sympathetic and kind—to their mothers, to their favorite teachers, to their closest companions and friends. Children, like savages, feel that frankness and candor are precious gifts, pledges of affection, to be bestowed only upon near and understanding comrades, and that a stranger, or an elder, or a representative of authority, is a sort of impersonal or potential enemy, an alien and a spy, with

no title to the free exchange of confidence, an inquisitor whose entrapping questions are rightly countered with an equal craft. Veracity, therefore, is a thing to be wooed and courted, not a thing to be ordered or enforced. Nor should those whom the child dislikes or dreads cross-examine him when there is the smallest risk that he may parry them with a trumped-up tale.

The habitual liar is apt to be an egoist and an introvert. He walks on a solitary stage where he sees himself always in the heroic, self-defensive rôle; of what those outside him are thinking, and particularly of what they think about the vice of falsehood, he has but the vaguest inkling. When his conduct and its consequences are roundly put to him, he is aghast to learn what a deep hostility his paltry fibs are causing. Often this very antagonism, which he ascribes to no fault of his own but to mean conspiracy or prejudice, thrusts him still further back upon himself. He slinks into his mental cell and slams the door. It is, therefore, vital that at an early moment some one should make kindly overtures; softly draw the little skulker out of himself again; lead him back among tolerant friends, and win him gently over to a finer care for the opinion of his fellows and a keener sense of social foresight.

Should any form of rebuke or punishment seem necessary, the best measure is not to stigmatize the child to his face as a liar, nor yet to thrash him there and then, much less to expatiate on how he has pained you: it is rather to cut or cold-shoulder him (as you might any adult acquaintance whom you found dishonorable) until of his own accord he resolves to prove himself worthier of your trust and credence.

The inventive child should never be laughed at or admired for his ingenious concoctions. The imaginative verbalist should not be called out before the class to improvise exciting stories of his own. The proper treatment is a chill indifference. Darwin relates in his *Autobiography* how he was cured of sensational story-telling by the icy silence with which his most startling narratives were always received.

5. *Literary Instruction*.—Yet the childish fantasy must not be too ruthlessly suppressed. Another autobiographer, Sir Edmund Gosse, describes how, in the endeavor to cultivate in

him a spirit of pure truthfulness, his mother refused to let him hear, read, or write any fiction whatsoever. "They desired to make me truthful; the tendency was only to make me positive and skeptical."<sup>32</sup>

With the young fabulist who is telling himself or others extravagant romances because his own life is so limited and dull, the best course is to enlarge and enrich his range of actual experiences. Let him learn that truth may be more thrilling and more entrancing, as well as stranger, than fiction. Travel, school journeys, visits to places of interest, will give him authentic matter to relate. With older children the over-active imagination may be given its needful grist through good fiction, good poetry, and good romance—Scott or Shelley, Dumas or Conan Doyle. With younger children of a nervous fancy, the stimulus of the cinema and the fairy tale is sometimes best withheld: and oral composition should be exercised through precise observation and logical reasoning rather than through memory or imagination.<sup>33</sup> At times a bracing course of literary nonsense—the tales of Lewis Carroll and the rhymes of Edward Lear—may assist the child to distinguish between absurdity and fact within his own confused experience.

6. *Scientific Instruction*.—Crude homilies on the sinfulness of lying are of small avail, and to cite the fate of Ananias may create more harm than holiness. The child should be led to understand what a baffling thing it is to formulate the precise and literal truth. The task of the truth-teller is twofold, first to know, and then to express. Each is a science in itself. The schoolboy can be shown how, even with instruments ingeniously contrived for the purpose—a plumb line, a spirit level, or a stop

---

<sup>32</sup> *Father and Son*, pp. 23-24. It may be observed that Sir Edmund Gosse's mother, having been lectured when eight years old by a Calvinist governess on the wickedness of entertaining her brothers with stories such as she read in books, grew to be so obsessed by the sinfulness of story-telling that, at the age of twenty-nine, she was still praying to be delivered from her "corrupt propensity" and ever afterwards excluded all novels or story books from her house (*ibid.*, pp. 21-22).

<sup>33</sup> See, for sound advice upon this point, Dr. Crichton Miller's discussion of Madame Montessori's well-known prohibition against the fairy tale: (*The New Psychology and the Teacher*, Chap. iii, "Reality and Phantasy").

watch—it is never easy to be exact, and that many languages, many literary styles, and whole libraries of philosophy have been constructed in the effort to impart what each man thinks. To the youthful mind, an ounce of scientific instruction and of linguistic practice is far more helpful and wholesome than any quantity of high-flown narrative or of trite and tedious moralizing.<sup>34</sup>

Truth is accuracy to fact, and as such it is to be placed before each pupil as an intellectual rather than as a moral obligation. How often even the cultured teacher is blind to this profounder aspect, failing to see that lying is always relative, not absolute, and that there must be infinite degrees of falsehood just as there are innumerable nuances of truth. The unsophisticated child is often shrewd and perceives with amazement how grown-up men receive from other grown-up men the mere assertion of beliefs and opinions as though they were realities, as if for an adult a simple unsubstantiated statement were a sufficient guarantee. Such a child should learn rather that the logical mind looks first for objective evidence and seldom sets much store by mere asseveration, and that consequently it is really not worth while to lie because a critical mind puts so little weight on human utterance unsupported by producible proof.

7. The Avoidance of Pious Figments.—Finally, if you wish the child to tell no lies to you, have a scrupulous care to tell no fables to the child. Myths about Father Christmas, the all-seeing Eye, the origin of babies, and the riddle of sex, should never be offered as facts to the young and sensitive inquirer. The strongest shock may ensue when the child finds out that those whom he thought impeccable have told him tales about the most solemn of mysteries, and it is no more than a natural reaction should he start fabricating lies and legends of his own.<sup>35</sup>

---

<sup>34</sup> Healy recommends exercises on testimony and report based upon the tests for those qualities (*Pathological Lying*, pp. 274-5).

<sup>35</sup> See, for the importance of these and kindred points, the writings of the psycho-analytic school, e.g., Ernest Jones, *Papers on Psycho-analysis*, Chap. xxxiv, "The Significance of Sublimation for Education and Re-education," and Chap. xxxv, "The Unconscious Mental Life of the Child," or Barbara Low, *Psycho-analysis*, Chap. vi, "Social and Educational Results."

## CHAPTER IX

### TEMPERAMENTAL CONDITIONS: INSTINCTS AND EMOTIONS

*Dieu nous incline vers le bien du corps par instinct. C'est obéir à sa voix de se rendre à cet instinct de la nature, qui nous porte à satisfaire nos sens et nos passions. Cette disposition est fort ordinaire aux jeunes gens.*

God disposes us to seek the well-being of the body by instincts. To obey these natural instincts, which lead us to the satisfaction of sense and passion, is to obey His voice. It is an inclination particularly common among young people.

MALEBRANCHE.<sup>1</sup>

### The Emotional Aspect of the Mind

On proceeding to analyze the psychology of the young delinquent, we found it a convenience to bisect the mind into two distinguishable parts, the intellectual and the emotional. Of these twin parts or aspects the former alone has occupied us throughout the last two chapters. The intellectual nature of the child—his general intelligence and his special talents, his inborn capacities and his acquired attainments—these have been discussed in detail and due order. We turn now to the emotional side, and shall study at some length what is plainly of far greater moment in dealing with the criminal, his character or temperament. "Character" and "temperament" are terms that I use loosely, and here almost with indifference,<sup>2</sup> to disig-

---

<sup>1</sup> *De la Recherche de la Vérité* (1674), liv, v.

<sup>2</sup> If a division is to be made between them, the word "character" may be used where reference is primarily to moral and therefore to acquired factors, and the word "temperament" where the reference is primarily to emotional and inborn factors. The term "temperament" is thus employed in a somewhat broader and more popular sense than is usual in most psychological textbooks: (see, however, Shand, *The Foundations of Character*, for a closely similar definition—"By 'temperament' we mean that part of the innate constitution of the mind which is different in different men, so far as this refers to their feelings and perhaps also to their wills"—*loc. cit.*, p. 129). The name "disposition" has been



nate the sum total of those personal qualities of mind which do not constitute, or are not pervaded by, intelligence. In technical terms, they may be said to cover all tendencies composed in their essence of affective and conative elements rather than of cognitive; they are marked by feeling rather than by knowledge, by will rather than by skill.

## The Measurement of Temperamental Tendencies

### *Experimental Methods*

A child's temperament is always more difficult to judge than his intelligence. Intelligence is relatively constant: emotions are vacillating and evasive, hard to seize and harder still to measure. How far, then, and by what artifices, can they be accurately assessed?

Here, as in every science, two avenues of approach are open—experiment and observation. To the study of temperament or character, the devices of experiment, applied with such success in the study of intelligence, have not been adapted upon any systematic scale until quite recent years. Binet, to be sure, who worked so fully on tests of intelligence, was also among the first to essay the measurement of moral qualities. His tests for estimating the suggestibility of children, the correctness of their testimony and the fidelity of their reports, I have alluded to already. But his experiments were few, and for long they were allowed to lie where he left them. Of late, however, many ingenious workers have entered this new field, and if only to show the limitations of existing methods, it will be useful at this point to glance rapidly over the more promising lines of research and to touch briefly on their applicability in detecting a disposition towards crime.

1. *Emotional Tests.*—The tests that have been used are broadly of two kinds, emotional tests and moral tests. Among the former—tests concerned primarily with the emotions—the

---

proposed by McDougall, as including the sum total of a person's specific emotional dispositions (*Social Psychology*, p. 120). But this usage of the word, convenient as it is for scientific purposes, would seem a little forced in popular discussion, nor does the noun "disposition" possess any serviceable adjective.

most effective are the associative reaction and the so-called psycho-galvanic reflex.

Devised long ago by Sir Francis Galton, the associative reaction has been lately taken up and freely used by psychoanalysts.<sup>3</sup> The method is simple. The examiner calls out, one by one, a prearranged list of disconnected words. Throughout the series are interspersed what may be called incriminating stimuli, words calculated to strike some particular emotion, or perhaps to hint at some culpable experience plausibly suspected but not definitely proved. To each word the examinee is required to reply as quickly as possible with the first word that comes into his mind: for example, *Head?* "Master," *Father?* "Cross," *Girl?* "Friend," *Laugh?* "Pictures," *Fear?* "Stick," *Love?* "Mother," *Anger?* "Father," *Ask?* "Penny," *Money?* "Stolen," and so on.<sup>4</sup> The time taken for each response is

<sup>3</sup> Galton, *Inquiries into Human Faculty* (1883), pp. 133-46, "On Psychometric Experiments." For psycho-analytic applications see Jung, *Studies in World Association* (1918), and for early criminological applications, Wertheimer, *Experimentelle Untersuchungen zur Tatsbestandsdiagnostik* (1905).

Two recent adaptations of this method are of special interest to the student of juvenile delinquency. Moore gave his subjects a series of concrete nouns naming types of situation that provoke particular instincts, e.g., "insult" (suggesting pugnacity), "success" (suggesting self-assertion), "danger" (suggesting fear). The subject was required to respond with an appropriate verb, and it was assumed that he would respond most readily when his strongest instincts were touched upon ("A Method of Testing the Strength of the Instincts," *Am. Journ. Psych.*, XXVII, 1916, pp. 226-33). Moore's special list of words and his special technique have led, in my own inquiries, to no very successful results; but his principle seems capable of fruitful development, particularly (if my data can be trusted) when concrete pictures are substituted for mere words. Another investigator, Marston, has used the associative method to detect a so-called lying complex. It appears that liars are chiefly of two types. Some reveal their deceitfulness through the direct effects of self-conscious embarrassment, which issues, as a rule, in retarded and confused reactions to critical words. Others, by sheer power of concentrated attention, deceive the superficial observer more completely, but betray their dishonesty in the test by reactions that are a little too quick and eager ("Reaction Time Symptoms of Deception," *Journ. Exp. Psych.*, III, 1920, pp. 136, *et. seq.*).

<sup>4</sup> The examples quoted are taken from a hundred replies given by a boy of thirteen who had stolen half a crown and had spent it at a cinema with a girl acquaintance. The lists of words most commonly employed are those of Jung (*loc. cit.*, p. vii), and of Kent and Rosanof

measured in fractions of a second with a stop watch or a chronoscope. The answers themselves are compared with a standard collection compiled beforehand from a thousand normal persons, and the general frequency of each can thus be ascertained. The significant replies are those that are unusual and those that are delayed. The few investigations that have been made with criminals show that it is possible, by this means, not only to lay bare the man's deeper emotional interests, but also to unveil a guilty consciousness of some specific crime.

The so-called psycho-galvanic reaction is often utilized in conjunction with the foregoing test. The experiment rests on a singular phenomenon. Whenever a person experiences a transient emotion, the resistance that his body offers to an electrical current is for the moment reduced. If, therefore, electrodes be attached to the palms of either hand and connected by wires with a galvanometer, the deflections of the needle reveal at once whether his ideas—excited by some particular word, name, object, or picture—are taking an emotional turn. The extent of the deflection answers roughly to the intensity of the person's feeling, and again it becomes possible to explore his strongest interests and to discover his most sensitive thoughts.<sup>5</sup>

---

("A Study of Association in Insanity," *Am. Journ. Insanity*, LXVII, 1910, i, pp. 37-96, and ii, pp. 317-396). Neither list is very well fitted for use with English children, and the English psychologist ought rather to construct his own.

<sup>5</sup> See Jung, *loc. cit.*, pp. 446-530. The cause of the phenomenon is still not accurately known. It has been supposed that every emotion is accompanied by a slight reflex increase in the perspiration of the skin. Since the skin is the chief seat of the resistance offered by the human body to the passage of the current, the moistening of the parts in contact with the electrodes would thus temporarily lower that resistance. In this country, the first experiments with the psycho-galvanic method were those carried out by Mr. R. C. Moore and myself, with the assistance of Dr. Roaf and Dr. Graham Brown, in the physiological laboratory at Liverpool University. It proved possible to demonstrate to a jury of research students which among a series of suspected persons was guilty of an artificial crime. For recent work with the test upon more general lines the reader may be referred to Whately-Smith, *The Measurement of the Emotions* (1922), and Prideaux, "Expression of Emotion as shown by the Psycho-galvanic Reflex," *Brit. Journ. Med. Psych.*, II (1921), i, pp. 23-46.

Besides these two more striking devices, endeavors have also been made to measure the changes of pulse, blood pressure, and respiration produced by emotional stimuli; such attempts, however, have proved more suggestive for theory than for practice. The study of muscular movements is a further method, and one that involves a simpler technique and admits of wider application. Every observer of human nature knows how men disclose their thoughts, their moods, and their emotional dispositions, unconsciously and despite a fixed intention to conceal them, through peculiarities of voice and gesture, or by some slight and fleeting movement of the hand or eye, or by small but significant changes in expression, gait, and bodily bearing as a whole. As a typical form of muscular movement, indicative of temperamental qualities and readily measureable by rapid means, handwriting has often been employed. One well-known scale for temperamental measurement, Dr. Downey's "will-temperament" test, depends upon this principle. The subject is required to write a chosen phrase at normal speed, at maximal speed, and then as slowly as he can; to disguise his normal handwriting; to imitate a model script; and to continue his writing during slight and unexpected distractions. By means of these and other similar exercises, Dr. Downey believes it possible to detect and estimate three main groups of temperamental qualities—speed and ease of reaction, decisiveness and forcefulness of reaction, persistence and carefulness of reaction.<sup>6</sup>

All the foregoing tests turn primarily upon the extent to

---

<sup>6</sup> June E. Downey, *The Will-Temperament and its Testing* (G. G. Harrap & Co., 1923). The same investigator has applied a similar technique with speech instead of handwriting as the diagnostic medium (cf. *loc. cit.*, pp. 238-43). Although the "will-temperament scale" has been freely employed in the United States, and apparently with much success, I have obtained, among my own experiments, but poor results from it: the correlations, alike with independent estimates, with the speech form of the tests, and with results of the same test repeated for reliability, are never more than moderate. Indeed, it would seem that the first inquiry needed is to ascertain which, if any, of the temperamental qualities are truly general—indisputably common to all forms of muscular movement—and how far handwriting may be treated as a typical example. It cannot be denied, however, that, from time to time, very significant deductions are suggested by the application of the scale to individual cases.

which the subject betrays his emotions by slight bodily disturbances. Others turn chiefly upon the degree to which his emotions disturb the processes of his mind, affecting his attention, his memory, or his preferences. The former depend on the way he reacts to stimuli; the latter on the way the stimuli react upon him. Thus, one group of tests may be said to use the method of *expression*; the other, the method of *impression*. Though hitherto but little used, the method of impression seems by far the more promising for practical work. It is capable of the most varied adaptations. It allows but little distortion or disguise. A series of illustrative drawings, for example, may be put before the subject, and afterwards he is asked to describe or to identify them: it is assumed that those that impinge on ideas most active in his mind will be the most intently noticed and the most minutely remembered. Sometimes he is given a selected set of colored picture postcards, humorous, sentimental, artistic, and the reverse, appealing to various tastes and different feelings, and is then desired to rank them in the order of his choice. Sometimes he is given the outline of a story and is required to fill in the missing sentences; the method resembles the completion test, used for testing intelligence, but the narrative is drawn up in such a way that the subject's own insertions may indicate his temperamental qualities rather than his intellectual skill. Sometimes he is shown a list of suitably selected words and is told to underline those that are connected with some personal worry or dislike. Sometimes he is given a list of questions relating to specific temperamental symptoms and leading him to analyze his own predominant emotional traits.<sup>7</sup>

---

<sup>7</sup> The last three methods may be used as group tests. For an instance of the first—the unfinished story—see Myerson, "Personality Tests involving the Principle of Multiple Choice," *Arch. Neur. and Psych.*, I, 1919. The second is based upon a test extensively employed in examining American recruits during the war: for details of procedure see Pressey and Chambers, "First Revision of a Group Scale for Investigating the Emotions with Tentative Norms," *Journ. Appl. Psych.*, IV (1920), pp. 97-104. The third—that of the temperamental questionnaire—has been employed in countless forms: the most widely used are those based on Woodworth's list of questions, intended for detecting soldiers with neurotic tendencies; a revised and expurgated form for use with children



2. *Moral Tests*.—Moral tests have been used less freely than emotional. The majority are designed to measure moral judgment and discrimination; a few, to measure moral strength or control. One method is to prepare a list of offenses, each described in concrete detail upon a separate card—breaking windows, robbing an orchard, scalding the cat, not going to church, flirting with a stranger, committing suicide, killing a thief, and the like. The examinee is required to arrange the offenses by what he takes to be the degree of their relative wickedness: the arrangements made by individual delinquents differ significantly, so it is found, from those of law-abiding children and adults.<sup>8</sup> The test is much improved if, instead of verbal descriptions, pictures are employed, representing the various actions to be judged.

A better method still is to describe not actions but individuals: a number of photographic portraits, accompanied by short character sketches, are placed in sets of ten before the child, and he is asked to arrange each set in order of preference, as if he were selecting these persons for his friends. The normal order of preference is known from standardized trials, and, as usual, the correlation of the examinee's order with the normal order measures the normality of his choice. The following, for example, are three from a series of ten character sketches for older girls:

1. LILY is smart and clever. She is good company and is always making the other girls laugh. She says that she is too old for

---

has been drawn up by Ellen Matthews ("A Study of Emotional Stability in Children," *Journ. Delinq.*, VIII, 1923, pp. 1-40) and by Cady and Terman (*loc. cit. inf.*). Other references will be found below, page 397, footnote 23. With all these methods, however, the American test material is not well suited for English children. In England, the Vocational Department of the National Institute of Industrial Psychology has recently undertaken a revision and extension of temperamental questionnaires, and a particularly suggestive series, arranged for the most part according to the several human instincts and emotions, has also been drawn up, in conjunction with Mr. Flügel and others, by Mr. E. J. Dilston Radclyffe, and has been tried with some success at the London Day Training College and elsewhere.

<sup>8</sup>Fernald, *Am. Journ. Insanity*, LXVIII (1912), p. 547; Haines, *Psychol. Rev.*, XXII (1915), p. 303.

playground games and the girls' clubs have too many rules; but she is the leader of a group of big, healthy girls, who have great fun out of doors in the dark evenings and are rather fond of teasing the old lady who keeps the candy shop round the corner.

2. JANE looks pale and is badly dressed. She does not mind doing dirty work like scrubbing and cleaning, and when she has a little time to herself, she would rather be studying some dull lesson book than playing games with other girls. She is always thinking about her examinations and never cares to join in a lark.

3. MARY is a lively, good-looking girl. She loves romping with the boys, and when her mother scolds her, she does not lose her temper, but just laughs. She never tells tales, and says it is silly to make a fuss if a poor girl takes a penny that belongs to a richer girl who really would not miss it.

Even more instructive is it to ascertain what is the child's real attitude towards common social problems stated without any overt reference to delinquency. In a group test, for instance, situations of the following type may be named or indicated, and four or five alternative reactions may be described to the child. He is then asked to choose from each set of replies the one which best indicates how he himself feels about the matter and the one with which he least agrees. I append a few selected specimens:

1. SCHOOL.—(1) Very few children would go to school unless they had to. (2) Some teachers are unfair, and are always finding fault. (3) There are many useful things which you are never taught in school. (4) Those who always know their lessons only do so because they are the teacher's favorites.

2. PARENTS.—(1) You should always obey your mother and father even if they tell you to do wrong. (2) Parents are very kind to you when you are little, but when you go out to work they ought not to want to know everything you do. (3) Some parents are unkind to their children, but most parents act for the best. (4) Some parents expect their children to do all the errands and the housework and then refuse to let them play games or go out.

3. THE PICTURES.—(1) No children should go to the pictures until they are over thirteen. (2) The love stories which you see at the cinema have a bad effect on the minds of children. (3) Some children enjoy going to the pictures more than stopping at home. (4) It is wrong to ask for money just to go to the pictures, but there is no harm if you can slip in halfway through without paying.

4. SMOKING.—(1) It is difficult to refuse to smoke when all the other fellows are smoking too. (2) You should not waste money on packets of cigarettes, but there is no harm in smoking cigarette ends that other people have thrown away. (3) Men and boys should never smoke. (4) An occasional cigarette does not hurt you when you are old enough.

5. GIRL FRIENDS.—(1) It is best never to go with girls, because then you are never likely to go wrong. (2) Most girls are too cowardly to join in any real piece of fun. (3) Sometimes a girl and boy get on better together than two girls or two boys. (4) Girls are all very well for an occasional lark; but sometimes they tell tales.<sup>9</sup>

Healy<sup>10</sup> sets his juvenile offenders a couple of problems that are rather more complex; both call for an appreciation of the moral issues involved in a somewhat exceptional situation:

1. A poor man was so sorry for a sick widow and her starving children that he took some bread that did not belong to him and gave it to them. Did he do right or wrong?

2. An Indian chief threatened to burn a village and its inhabitants unless a certain white man was given up to him. The villagers knew that the white man was innocent and would be tortured and killed, and that the Indian chief could easily burn the village, as he said. Had you been one of the villagers, what would you have advised?

Another American investigator<sup>11</sup> prefers to use a booklet of six tests, each test containing some twenty or thirty ethical problems. The child is required to define moral terms (good, wrong, temperance, etc.); to mark the worst offense in each of

<sup>9</sup> The statements are nearly all picked from children's voluntary comments in essays written on these subjects. The difficulty is so to select or rephrase them that the final choice shall be as genuine and as unsophisticated as possible: this can only be done through repeated trials. To require such a test to be answered at full speed and to insert it among others that ostensibly test intellectual knowledge rather than moral opinions, will conduce to the same end.

<sup>10</sup> *Loc. cit.*, pp. 98-99. The problems, here slightly abridged, were first used by F. C. Sharp, *A Study of the Influence of Custom on the Moral Judgment* (University of Wisconsin Bulletin, 1908).

<sup>11</sup> Kohs, "An Ethical Discrimination Test," *Journ. Delinq.*, VII (1922), i, pp. 1-16.

a given series (*e.g.*, over-eating, getting tipsy, smoking, dancing, drinking); to assign the appropriate punishment or reward for specific actions (*e.g.*—for conceit, honesty, dirtiness, laziness, or blackmail—death, imprisonment, praise, scolding, or nothing at all); to select the right meaning to certain ethical proverbs (*e.g.*, “God helps those who help themselves”); to supply the correct reasons for certain moral prohibitions (*e.g.*, “why should you not steal a penny from a blind man’s cup?”); and, finally, to state the proper course of action in certain social situations (*e.g.*, “if another boy hits you without meaning to, what should you do?”)—the last a type of problem suggested by exercises in the Binet Scale.

Of these so-called moral tests, however, the greater number palpably depend quite as much upon intellectual comprehension as upon ethical beliefs or criminal tendencies. With children, in particular, effort is chiefly needed to understand the question and to reason out a suitable reply; indeed, among the questions I have just cited, the last was used by Binet himself to test, not character, but intelligence. Even when the child has grasped the problem, his answer will reflect not the blind impulses which he would obey in practical life, but his conscious or professed opinions or the opinions of which he supposes his catechist to approve. And the examiner, as he listens to aphorisms of piety on the lips of the most depraved, is continually constrained to murmur: “Not every one that saith unto me. . . .”

This intellectual element the so-called tests of moral control are intended to shut out; but, even then, it still remains a matter for doubt how far the experimenter can justifiably argue from “will-power” exhibited in the laboratory to the exercise of “will-power” in the street or in the home. Moral control is generally tested by an actual trial task: the test (if one may borrow a convenient phrase from work upon intelligence) is of the “performance” type. Fernald<sup>12</sup> measures self-command by the time the candidate can balance himself upon the ball of the foot; Downey<sup>13</sup> measures self-confidence by noting the way

<sup>12</sup> “An Achievement-Capacity Test,” *Journ. Educ. Psych.*, III (1912), pp. 331–336.

<sup>13</sup> *Op. cit.*, pp. 118, 124 *et seq.*

the examinee reacts to contradiction and to some unexpected obstruction of a movement that he has been asked to make with both eyes closed; Moore and Gilliland<sup>14</sup> measure self-assurance or the lack of it by requiring the examinee to return the fixed gaze of the examiner during the performance of some mental computation and by then counting the number of evasive eye movements made by the embarrassed calculator; Voelker,<sup>15</sup> by constructing more natural situations, tests the child's inclination to cheat when he is no longer watched, to accept help after a promise of refusal, to return a borrowed article, to retain an excess of change from a purchase, to take a tip for trifling courtesies, and to neglect a routine task under tempting distraction. However, all the practical tests in common use—the maze tests devised by Porteus,<sup>16</sup> for example—will provide in some degree a measure of reckless and impulsive action and of the power to control it. And the child's variability in repeated tests of almost any simple kind may yield a fair index of the instability of his moods.

But with all forms of individual testing, where the child is examined privately and by himself, and particularly with sustained exercises of the practical or non-linguistic type, the most helpful suggestions are to be gained, not from any formal or

---

<sup>14</sup> "The Measurement of Aggressiveness," *Journ. Appl. Psych.*, V (1921).

<sup>15</sup> Voelker, "The Functions of Ideals and Attitudes," *Col. Univ. Contrib. Educ.* (1921).

The procedure employed in most moral tests of the "performance" type—trapping the less scrupulous by a seeming suspension of vigilance—is again based upon a principle devised by Binet. A plan analogous to those described above is to ask the children to work sums or spell words which are rather hard for them. Concealed in their writing pads are sheets of carbon paper. The secret copies are abstracted and retained by the examiner, and the top sheets torn off and handed back to the pupils to mark for themselves. The illicit correction of figures or letters, detected by the aid of the carbon copy, is taken as an index of the child's dishonest tendencies. In such a test, however, some may be disposed to think the morals of the examiner are as much in question as the morals of the examinee.

<sup>16</sup> "A Study of Personality of Defectives with a Social Rating Scale," *Vineland Training School Bulletins*, XXIII, and other papers. The mazes employed are reprinted in my *Handbook of Tests for Use in Schools*, pp. 96-106.



quantitative mark, but rather from an alert attention to his method of attack—his confidence, his heedlessness, his readiness to coöperate, his attitude when faced by difficulty or doubt: the side lights so secured are often far more illuminating and far more correct than any single score upon a scale. It is true, a few enterprising workers have sought to adapt the written or group procedure for ethical testing and to examine children's moral control by paper work in class. But this inevitably forfeits any opening for individual observation. Of such ethical class tests perhaps the most instructive is the set recently drawn up by an American investigator and applied to groups of delinquent and non-delinquent lads. The child is required to trace mazes with closed eyes; to fill up and correct completion tests with the key temptingly accessible upon the back; to say how much he knows of various topics, with the prospect of earning a box of confectionery, should he obtain full marks. The measure is the number of times he cheats or over-states; and the marks are found to correlate with independent ratings for moral character to the extent of .42.<sup>17</sup> The written questionnaire, applied, as we have seen, to temperamental qualities, has also been adopted for ethical qualities, and the examinee,

---

<sup>17</sup> Cady, "The Estimation of Juvenile Incurability," *Journ. Delinq. Mon.* (1923). More recently still a somewhat similar series of tests has been worked out by A. S. Raubenheimer ("An Experimental Study of Some Behavior Traits of the Potentially Delinquent Boy," *Psych. Mon.*, 1925), and has been applied with slightest modification by Terman in his study of supernormal children, *Mental and Physical Traits of a Thousand Gifted Children* (Stanford University Press, 1925, pp. 485-517).

In my own experiments I find that such tests, when administered by the group method, depend far more upon the general tone of the school or class as a whole, and vary little with individual peculiarities. Certainly, with or without the group procedure, if a particular child *does* cheat, the natural deduction is a safe one; but, if he does not, he cannot be acquitted with an equal assurance. In this country, teachers and research students should apply such tests very gingerly, and if untrained in psychology, leave them altogether alone. As is manifest from protests published in the daily press, the purpose and nature of these expedients are easily misinterpreted by the public mind; and there can be little doubt that the lay experimenter may do more mischief than good—injuring the cause of psychology, even if he does not injure the morals of the child.

as in the research just mentioned, is sometimes given a syllabus of questions inquiring into his own moral character: "Do you often lose your temper? Can you control your feelings of jealousy and envy? Do you get on well with teachers and with other children? What kind of boys and girls do you like to go with? What do you think about when you are alone? What would you do if a large sum of money were left you? Would you like to wear jewelry and fine clothes? Would you like to go to the pictures every day?"<sup>18</sup>

On the whole, however, an indirect technique is far preferable to a direct. The moral test should be camouflaged, as it were, in the guise of a test of intelligence or of general information. The optional question paper is full of possibilities in this direction. Every teacher knows how, in examinations on languages or mathematics, the indolent choose the mechanical questions, such as need no strenuous thought, while the more enterprising make for the problems and the riders; the cautious prefer the prepared texts; and the venturesome, the unseen translations. With material suitably compiled the artifice may obviously be adapted to throw into bold relief the general inclination of the child.

That tests, such as those I have described, can claim more than a mere experimental interest, few at present would go so far as to pretend. I hope, when further data have been collected from both normal and delinquent children, to publish statistical results showing the practical value and limitations of the different methods here reviewed. So far as my present findings can be trusted, the self-consistency of the several tests varies from about .40 to .75; and their correlation with independent estimates of the qualities tested from .35 to .65. The figures are encouraging, but too poor for practical work. Terman puts the position in a sentence: "The reliability and validity of tests for moral traits have proved lower than an optimist might have hoped for; but the correlations obtained are quite as high as

---

<sup>18</sup> The sample questions which I have quoted above are taken from several different group tests. On the general method of simple interrogation, whether applied to group testing or to individual testing, see footnote 24, pages 397-8.

those yielded by the early intelligence tests of fifteen or twenty years ago; and this is no small achievement."<sup>19</sup>

### Observational Methods

For all practical purposes, therefore, in dealing with delinquents and in cases of every kind where temperamental and moral qualities have to be assessed, we are driven to place our faith more in the method of observation than in the method of experiment. To the observer who knows what signs to look for, the child's face, physique, and general deportment are always rich in significance. Physiognomy as a science has been much neglected. It was shown long ago by Darwin that almost every human emotion has its instinctive expression on the face, produced by slight movements of the eyes, the lips, and the muscles of the cheek and brow. Hence, a child's habitual cast of countenance and his facial play under appropriate stimulation may indicate his dominating mood and chief susceptibilities.<sup>20</sup> The whole build of his body, the structural peculiarities of his general physique, are at times suggestive of constitutional conditions, such as often bring with them distinctive qualities of temperament. Of these physical signs, some, as we have already noted, point to specific disturbances of the glandular secretions, and the secretions themselves, as the old doctrine of temperamental "humors" rightly divined,

---

<sup>19</sup> Preface to Cady's monograph, *loc. cit. sup.*, p. 4. I may add that, with emotional and even more with moral tests, there is a striking improvement in marks from age to age—a rise not wholly explained by increase in intelligence; towards puberty this rise becomes still further accelerated in the moral tests, but tends to be temporarily reversed in the emotional tests owing to pubertal instability. This suggests both the possibility and the limitations of an age scale for temperamental and moral characteristics. Sex differences are noticeable: girls seem superior to boys in nearly every trait except trustworthiness; and, in particular, the pubertal improvement indicated by the moral tests appears much earlier in girls than in boys.

<sup>20</sup> For the qualities which may be so judged with greatest reliability, see Burt, "Facial Expression as an Index of Mentality," *Child Study*, XII (1910), i, pp. 1, *et seq.* Cf. Dewey, "Judgments of Emotions from Facial Expression," *Journ. Abn. Psych.*, XIII (1919), pp. 172-84; *cf. id. Psychol. Rev.*, XXV (1918), pp. 488-94, and Dewey, *Journ. App. Psych.*, V (1921), pp. 152-5.

have a far-reaching influence over emotional states.<sup>21</sup> Along each of these two lines—from physiognomy and from glandular symptoms—much help in temperamental diagnosis may be anticipated in the near future from prolonged research. The few concrete inferences warranted by existing knowledge may be marked down from a first rapid glance.

For the present, the one safe method of approach, the only method that can be equally relied upon in every case, is the time-honored method of the personal interview—the close observation of the child's varying demeanor during a sustained conversation directed to this end. Tests and experiments are but supplementary to this.

*The Personal Interview.*—The interview is a method that admits of much refinement. By the use of a well-planned and well-standardized technique, by applying the scientific principles already worked out by psychologists for all forms of oral testing, much may be done to convert what is generally no more than a desultory talk into a systematic procedure for gathering pertinent facts. The results may be greatly improved by two devices in particular—the use of tabular schedules and the use of rating scales. My own practice involves a combination of both.

The student of Mrs. Thrale's diaries may remember how she made a "tabular-sketch" of the chief members of her circle, awarding her acquaintances quantitative marks on a scale of 0 to 20 for certain specified qualities: to Johnson she gave 20 for morality, 16 for humor, but 0 for good temper and 0 for manners: to Boswell 5 for morality, 3 for humor, and 19 for good temper; Burke gets 16 for religion, 10 for morality, but, strange to say, 0 for wit and 0 for humor; Garrick receives

---

<sup>21</sup> For a popular delineation of the types of personality supposed to be traceable to endocrine overaction or insufficiency—the positive and negative thyroid types, adrenal types, anterior and posterior pituitary types, the thymo-centric, the gonado-centric and the rest—together with their distinctive peculiarities of appearance and of temperament, see Berman, *The Glands Regulating Personality* (1921), pp. 202 *et seq.* Dr. Berman's whole-hearted theories, however, must not be absorbed without criticism, and unfortunately he furnishes the lay student with few references for his facts.

18 for person and voice, and as much as 19 for wit and for humor.<sup>22</sup> These quaint numerical tables are a striking forecast of the technical methods adopted by psychological observers of today.

For my own special purposes, I take, first of all, a classified list of temperamental and moral characteristics, expressible in recognized psychological terms.<sup>23</sup> The list embraces all the fundamental instincts and emotions and all the commoner interests, sentiments, complexes, and social habits acquired by persons of the age and type I am examining. Of these qualities each has been carefully defined beforehand; for each, the commoner symptoms have been noted down and appropriate questions framed; and, with each of them in view, circumstances and occasions, so far as is possible, are specially arranged to precipitate some hint, some clue, some small but telling indication.<sup>24</sup>

---

<sup>22</sup> *Thraliana* (unpublished MSS. in the possession of Mr. Salusbury), Vol. III, May 19, 1778. The table for Mrs. Thrale's male acquaintances will be found printed, not quite in full, in *Mrs. Thrale's Thraliana*, by Charles Hughes (1913), p. 21; the table for her feminine friends has, I think, never been published.

<sup>23</sup> Many inventories have been drawn up, cataloguing the personal qualities which it is most important to review. One of the earliest is an English list compiled, I believe, by Professor Spearman and published in Webb's "Character and Intelligence," *Brit. Journ. Psych. Mon.*, I (1915). Among others, the more suggestive are those of Johnson, "Emotional Instability in Children," *Ungraded*, IV (1920), p. 4 (based upon a well-known questionnaire of Woodworth), of Hoch and Amsden, "A Guide to the Descriptive Study of Personality," *Rev. Neurol. and Psychiat*, II (1913), pp. 577-587, of Yerkes and La Rue, *Self-Analysis: Outline of a Study of the Self*, 1914, and of Allport, *Social Psychology* (1922), Chaps. v and vi, esp. pp. 103 *et seq.* Allport's questionnaire and those of several other American writers are obtainable from C. H. Stoelting & Co., Chicago. Quite recently Terman has published some practicable schedules for rating character employed in a survey of supernormal children (*A Thousand Gifted Children*, 1925; see esp. Chap. xviii, "Trait Ratings").

<sup>24</sup> Every investigator gradually compiles for his own use a set of questions, more or less stereotyped and more or less widely comprehensive, which he habitually draws upon when interrogating the child himself or those who know him. I may be allowed to suggest two helpful expedients: first, the questions should be systematically arranged so as to cover for all cases all the more important emotions in turn; only in this way will the inquiry be complete; secondly, the questions should be



2 Secondly, in assessing the strength of these qualities, I adopt a uniform scale. The scale comprises five degrees, and no more. Accordingly, for every quality, each child is marked 5, 4, 3, 2, or 1—or, in letters, A, B, C, D, or E. These symbols indicate diminishing degrees of strength: A, much above average; B, slightly above average; C, average or medium; D, slightly below average; and E, much below average. The grades are defined upon a percentile basis. The whole population, or a random sample of it sufficiently representative, is conceived as being ranked in order, according to the intensity with which each person exhibits the quality in question; the group is then divided up by equal intervals into five successive classes. A, therefore, indicates that the child falls within the top 7 per cent, as thus marked off: B, the next 24 per cent; C, the middle 38 per cent; D, the next 24; and E, the lowest 7 per cent.<sup>25</sup> Should

---

phrased and formulated from the natural standpoint of the child. One questionnaire, for example, tells the examiner to ask the examinee: "Do you tend to get angry with your brothers and sisters?" This is not put from the standpoint of the examinee: *he* thinks, not of his own anger, but of the other person's provocative acts. To ask the child about his own angry tendencies will suggest to his guilty conscience that you are simply seeking, as others have done before, some ground for reproof, and will instantaneously set up an attitude of self-defense. The proper approach is, therefore, to inquire: "Does your brother tease you very much?" This will lead naturally to an inquiry as to what the brother actually does and how the examinee then behaves: and the examiner must judge for himself whether the behavior of the child is disproportionate. Generally, the first question on any point should relate rather to some other person than to the child himself: *e.g.*, "Has your father ever whipped you?" "Does your mother often scold you?" "What does she scold you for?" "Does she think you ought to come home earlier in the evening?" etc. If in these earlier stages of the interview the examiner is led to sympathize—or seem to sympathize—unduly with the child's own selfish attitude, the impression can be rectified towards the close by asking the child frankly to admit where he was wrong. This will then, in all likelihood, have a double weight and influence if the child feels that his own standpoint was understood at the outset.

<sup>25</sup> The use and basis of this scale are explained in detail in my small book on the *Distribution of Educational Abilities* (L.C.C. Reports, 1916, p. 50). The statistician will observe that its unit is the standard deviation. To the non-statistical it is sufficient to say: "Think of twenty children whom you know well, and arrange them in order according to the strength with which they show the given trait—*e.g.*, general emotionality. Mark the first or most excitable, A, and the next four, B; the

a finer grading be required, plus and minus signs may be affixed. But their value is probably fallacious. To differentiate between more than five gradations is, as a rule, in one short interview, to attempt the impossible.

*Standard Situations and Standard Personalities.*—Observational methods, such as these, may be helped out still further by one or two subsidiary contrivances. The number of observable traits may be extended by the use of standardized situations, and the accuracy of the rating scale may be much enhanced by reference to standard personalities.

In the artificial and well-disciplined atmosphere of a school or police court, children seldom exhibit their inmost qualities. Under more natural conditions, where conduct is spontaneous—at home, in the street, in the playground, and in places of amusement generally—their characteristic habits and true propensities come more quickly to the surface. "A man's nature," says Bacon, "is best perceived in privateness, for there is no affectation; in passion, for that putteth a man out of his precepts; and in a new case or experiment, for there custom leaveth him."<sup>26</sup> With a little management, under cover of a tea party or a holiday ramble, of a visit to the pantomime, the cinema, or the zoo, it is possible to conduct different individuals at different times into the same prearranged situations. Their characteristic reactions can then be observed and standards of comparison formed. To take a personal part in such experiments may not always be practicable for the psychologist himself. He must depend upon reports of willing assistants—teachers, welfare workers, research students, and charitable volunteers. It is imperative, however, that these observers, and indeed all who submit such statements, should describe

---

bottom or least excitable child E, the four next above him D; and the remaining central ten, C." Among numerous papers dealing with the problem of rating, the reader may be referred to Scott, "The Rating Scale," *Psychol. Bull.*, XV (1918), pp. 203-206, Thorndike, "Fundamental Theorems in Judging Men," *Journ. Appl. Psychol.*, II (1918), pp. 67-76 (compare *id.*, *ibid.*, IV (1920), pp. 25-29), and Rugg, "Is the Rating of Human Character Practicable?" *Journ. Educ. Psychol.*, XII (1921), pp. 425, 485, and XIII (1922), pp. 30, 81, *et seq.*

<sup>26</sup> *Essays*, xxxviii, "Of Nature in Men" (Everyman ed., p. 128).

concrete facts and actual behavior, and not merely their speculative inferences couched in popular or pseudo-scientific terms: to know that Harold went off with the nuts intended for the monkeys and that Lizzie pushed her little sister in the pond is far more enlightening than to be told (I quote one observer's account of these two incidents), "the boy seemed a plain case of kleptomania" and "the girl almost homicidal." Even where such helpers employ a well-defined list of temperamental attributes and conform to a uniform scale of rating, their bare marks should always be supplemented with a verbal epitome of the salient facts perceived.

The ratings of different observers may be made more nearly comparable, and the ratings of the same observer kept more closely consistent among themselves, if recourse is had to the same group of standard personalities or "key subjects"—typical individuals, that is, who are thoroughly known to all the observers and who are made to serve as common and constant points of reference.<sup>27</sup> Five representative children picked out at intervals along a percentile scale—the 1st, 3rd, 10th, 18th, and 20th in a sample group of twenty ranked as above described—are sufficient for rough purposes. Where the observers cannot all enjoy a first-hand intimacy with the living specimens themselves, detailed case descriptions may be used instead, and will to some extent supply the need for a concrete picture of representative types. These and similar expedients may combine to render the observer's judgments more objective; they certainly force him to reflect before he judges.

### Inborn or Inherited Tendencies

In reviewing the emotional qualities of any particular delinquent, it is desirable, wherever it is possible, to preserve the

---

<sup>27</sup> This plan was developed and used during the war by the American Committee on Classification of Personnel: see *The Personnel System of the U.S. Army*, Vols. I and II (U.S. Adjutant-General Office, 1921).

For a general discussion of psychological methods of estimating temperament, I may cite as an introductory volume Hollingworth's book on *Judging Human Character* (1923). An excellent bibliography of the subject will be found in Cady's article, "The Psychology and Pathology of Personality," *Journ. Delinq.* VII (1922), pp. 225-48.

same broad distinctions of origin and kind as were introduced in reviewing his intellectual qualities. We have to distinguish, so far as we can, first, the child's inborn tendencies from those that are acquired, and, secondly, his general stability of temperament and character as a whole from the specific strength of his several emotions and interests regarded one by one.

To discriminate what is innate from what is acquired or accidental is of paramount importance. To know whether a spiteful boy is inherently ill-tempered or merely chafing under some half-hidden grievance, whether an erring girl is constitutionally over-sexed or merely copying some corrupt companion, will make, in either case, a world of difference to the outlook and the treatment. What is inborn is incurable; what is merely superadded may yet be removed. Tests help but little here. For measuring inborn all-round emotionality we have no serviceable scale, like the Binet-Simon Scale for measuring inborn all-round intelligence. Physical signs of constitution or diathesis, such as those already alluded to, may in occasional instances yield fruitful hints. The characteristics of the child's parents and remoter relatives may at times be indicative of some hereditary trait. The early history of the child himself—the apparent origin, the first symptoms, the sustained consistency of his own peculiar aberrations—are perhaps the most instructive of all.

Thus, by every method and device he can apply and with the highest accuracy that he can muster, the first task of the psychologist in considering the personal character of each delinquent is to sift and separate what is original from what is acquired, to discriminate the primary defects in the child's congenital nature from the secondary defects in those overlying habits of moral control which are built up slowly during the long years of mental growth, and are gradually superimposed, step by step, and layer after layer, by experience, by social training, and by all the manifold influences of his *cultural milieu*.

What, then, are the inborn elements of character? And by what signs can they be known?

The foundations of character, as recent psychology has

taught us,<sup>28</sup> consist essentially in the inherited instincts, together with their accompanying emotions. These are the mainsprings of human conduct, the prime movers in all human life. It is they that supply both the driving force and the ultimate ends of all human activity, whether good or ill, social or antisocial, moral or immoral. To a brief examination of the universal instincts of mankind we must, therefore, devote ourselves first of all.

### Instinct and Emotion

An instinct may be regarded as an inherited physiological mechanism, common to all the members of the race and originally formed to meet those primitive conditions of existence under which the race was evolved. It consists in a threefold natural tendency—a tendency to perceive, and pay attention to, certain objects of vital importance (at least in uncivilized life) to the individual as well as to his species; to become pleasurable or unpleasurably excited about those objects whenever they are perceived; and thereupon to carry out, immediately and almost automatically, certain specific bodily movements, likely in the long run to preserve the individual, or at any rate the species, so behaving. An instinct is thus a source of interest, of pleasure, and of motion; it impels every child who is born with it to notice certain things, to experience certain feelings, and to act in certain ways. What those things, those feelings, and those acts will be we can foretell from our knowledge of human psychology: for all children bring with them the same repertory of instincts, and at bottom all are urged on by the same elementary motives.

No change, so far as we can tell, has occurred in the innate constitution of man since first he emerged from barbarism. The instincts which we inherit today are identical with those that served our forefathers, half a million years ago, on the

---

<sup>28</sup> This doctrine has been most clearly expounded by two contemporary British psychologists, W. McDougall, in his *Social Psychology* (Methuen & Co., 1908) and A. F. Shand, in his *Foundations of Character* (Macmillan & Co., 1914). These works should be textbooks for every student of the delinquent mind.



Asiatic steppes or by the European swamps. The same situations rouse us; the same movements relieve us. We are tugged, every one of us, savage and civilized, sinner and saint, by the same simple strings. The opposite sex, the young of our kind, our natural prey and our natural foes, these still tap the feelings of the polished citizen precisely as they stirred the soul of the prehistoric bushman; and until self-control and moral tuition have subdued afresh the earliest impulses of the growing child, these primitive thrills tend each to provoke some crudely appropriate reaction—cuddling, kicking, snatching, swallowing, hitting, running away—all types and patterns of behavior which, however indelicate in the classroom or the parlor, had obviously a rough and ready value in the forest or the cave.

What, then, is the relation of these primitive instincts to moral delinquency, of the paramount needs of bygone era to the crimes of the modern city child?

In an early table in this book, I enumerated and classified the chief complaints and charges alleged against the young offenders referred to me for study. On looking back to that list it will be seen that, according to the apparent nature of the precipitating motive, the offenses fall at once into certain well-marked categories; and, further, that these several categories, one after another, betray a close and curious correspondence with the accredited classifications of the primordial instincts of mankind.<sup>29</sup>

This unexpected parallel suggests a pregnant inference, a

---

<sup>29</sup> Table I, pages 14 and 15. It should be remarked that the main headings there given do not necessarily indicate the ulterior or predominant motive, but only what I have termed the precipitating instinct. Thus "soliciting" (there classed as a sexual offense) might be partly or even wholly due to a need for money; the need for money in turn to truancy from home; the truancy from home to an angry outburst; and the angry outburst at bottom to grief or fear.

Nor could the crimes of adults be forced without remainder into the same restricted scheme. Many counts may be entered upon an indictment which are of a purely political or technical complexion, and even with younger persons such common offenses as gambling and drunkenness can hardly be derived immediately from any one specific instinct. Offenders under these rubrics, however, are seldom brought to the school psychologist for special examination.

working generalization which I believe to be of the deepest significance and of the greatest use in the comprehension and treatment of juvenile crime. It may be formulated thus: *The commoner delinquencies committed by the young consist essentially, in almost every case, either of the hereditary reactions which constitute the universal human instincts, or else of slightly modified reactions elaborated out of, but still evidently springing from, these aboriginal modes of response.*

Where the overt movements to which nature prompts are wholly or partly checked (as, indeed, they are in almost every civilized adult), the internal excitement—the disturbance of the glands, the lungs, the heart, and other viscera—being beyond the power of voluntary control, still irrepressibly persists; it is the confused and overwhelming sense of this inward agitation that we call an emotion. An emotion, therefore, may be defined as the conscious aspect of a curtailed instinct, and, broadly speaking, to each particular instinct a specific emotion corresponds. Hence, in all but the most immature offenders it is the primitive emotion rather than the primitive instinct that provides the motive and the energy for crime.

### SPECIFIC INSTINCTS

#### General Influence

There is some evidence that human instincts are inherited, or tend<sup>30</sup> to be inherited, as unit qualities. If this be so, the intensity with which each of them is born in us may vary widely from man to man. It becomes, accordingly, conceivable that the inheritance of an ordinary emotion in an extraordinary degree may be sufficient to drive a young person to misconduct.

---

<sup>30</sup> I say "tend," because, to one who, like myself, holds the theory of "general emotionality," some qualification of this sort is vital; its special significance will emerge in a later chapter (see page 484). I must warn the student at once, and I shall repeat the warning, not to regard human life as a composite of clean-cut blocks. Life is one—a single, flowing stream, not an aggregate of discrete faculties or unrelated reflexes. The total of a man's emotional force is no mere additive collection of independent feelings or propensities. Rather, the several emotions themselves are but specialized differentiations of a primal emotional energy, of a fundamental will to live.

The violent-tempered child will commit assaults, the over-sexed child will commit sex offenses, the child of gipsy stock will wander, solely as a result of his unusual native endowment. Each will be swept along by the swift current of his strongest need.

A causation at once so simple and direct occurs, it is true, only among a few of the more easily analyzed types, such as are presented by the exceptionally young or the conspicuously defective. But what happens in these plainer instances will help us to unravel, or at least to understand the motives that run like a twisted skein through cases that are commoner and more complex.

Before any given person can be classed as a case of excess or defect in one or another of these instincts, it is proper to decide first of all on some uniform criterion of abnormality. The definition I have adopted is a statistical one. Any person deviating from the average by more than twice the standard deviation of the general population I have regarded as abnormal. In simple words, this means that one child in about every forty-three<sup>31</sup> (the top child when a group of that number has been ranked for the quality in question) is considered to suffer from an abnormal excess, and a like proportion (the bottom child in a group of about forty or fifty) from an abnormal deficiency. In dealing with immeasurable quantities like emotion, such a guide as this is, at its best, but crude and imperfect. But it is the safest rule available where abnormality is a matter not of kind but of degree. Holding so far as possible to this standard, I find that in nearly sixty out of every hundred delinquents, some instinct or other appears defectively or excessively developed, excess being far more common than deficiency; out of

---

<sup>31</sup> The exact percentage falling beyond the limit of  $+ 2$  S.D. is 2.3 per cent. It comprises all the individuals who, on my scale of marking (see page 398) would be marked A +. From Table XVII it will be perceived that, among the normal control group, rather more than the expected percentage showed excess or defect in many of the instincts. This may in part be the effect of chance; more likely it is due to the fact that, since the control group was chosen from the same low social strata as the delinquents, it contained a somewhat unusual proportion of families in whom the primitive instincts were strongly developed.

a hundred cases of non-delinquents, similar conditions are to be found in no more than twelve (Table III). In about 12 per cent of the delinquents, an excessive strength of some particular instinct seems, upon a nearer analysis, to be not merely contributory, but the sole or main cause of the child's offenses (Table XVII).

Any one, therefore, who would penetrate the motives of the young offender must first acquire some detailed understanding of the fundamental instincts that together make up our common human nature. He must begin by learning, so far as present knowledge can tell him, what they are, how they operate, and how they may be recognized and trained.

In the number and names of the instincts that they enumerate, psychologists differ. Nor is it possible to conceive these inborn tendencies as sharply marked off from each other by any clear-cut lines. For practical purposes, however, they may be treated as distinct and relatively independent.<sup>32</sup> And the list that I shall here adopt will be a composite of the catalogues drawn up by James, McDougall, Shand, and Drever—versions, after all, that diverge but little in the crucial points of classification.<sup>33</sup>

---

<sup>32</sup> All subdivisions of human instincts are more or less arbitrary and are to be followed for their practical utility alone. Thus, what for certain purposes may be usefully spoken of as a single or unitary instinct—such as sex, anger, curiosity, or fear—resolves itself, on narrower scrutiny, into a miscellaneous bundle of several subordinate impulses, each more or less independent: often the splitting off of some such partial impulse becomes regarded by society as a distinct vice or perversion as is seen in certain sexual practices and in certain habits of ill temper. Further, the subordinate responses of one instinct—*e.g.*, the tender reactions of the maternal instinct—may subserve another instinct, such as sex. McDougall's lucid classification brings with it both the advantages and the defects of too definite a differentiation. The partitions of his pigeon holes may look to some too straight, too rigid, too impermeable. But, as the reader will perceive in working through my own descriptions, to simplify and separate a little more than nature has done for us is almost unavoidable if exposition is to be clear.

<sup>33</sup> James, *Principles of Psychology* (1902), Vol. II, Chap. xxiv, "Instinct"; McDougall, *Social Psychology* (1908), Chap. iii, "The Principal Instincts and Primary Emotions of Man," and *Outline of Psychology* (1923), Chap. v, "The Instincts of the Mammals and of Man"; Shand,

TABLE XVII.—PSYCHOLOGICAL CONDITIONS, EMOTIONAL, INBORN:  
SPECIFIC INSTINCTS AND EMOTIONS

	DELINQUENT					NON-DELINQUENT		
	Boys		Girls		Average	Boys	Girls	Average
	Major Factor	Minor Factor	Major Factor	Minor Factor				
Gluttony.....	0.8	10.6	—	4.1	8.6	1.5	0.5	1.0
Sex.....	1.6	9.0	6.8	17.6	15.7	2.5	1.0	1.7
Homosexual tendencies <sup>1</sup> .....	—	4.1	—	1.4	3.0	0.5	2.0	1.2
Bad temper.....	0.8	9.8	2.7	13.5	12.7	1.5	2.5	2.0
Acquisitiveness.....	1.6	12.2	—	9.5	12.2	4.5	1.0	2.7
Wandering.....	3.3	10.6	1.4	5.4	11.2	2.0	0.5	1.2
Curiosity.....	—	5.7	—	4.1	5.1	—	—	—
Self-assertiveness.....	—	13.0	—	8.1	11.2	4.5	1.0	2.7
Gregariousness.....	—	6.5	—	2.7	5.1	1.5	—	0.7
Suggestibility.....	2.4	1.6	1.4	4.1	4.6	3.0	4.5	3.7
Affection.....	—	[2.4]	—	[4.1]	[3.0]	[2.5]	[6.5]	[4.5]
Timidity.....	—	[3.3]	—	[5.4]	[4.0]	[2.0]	[4.0]	[3.0]
Sorrow.....	—	[1.6]	—	[2.7]	[2.0]	[0.5]	[3.0]	[1.7]
Insusceptibility to sorrow.....	—	4.1	—	5.4	4.6	2.0	0.5	1.2
Insusceptibility to pain <sup>2</sup> .....	—	3.3	—	1.4	2.5	—	—	—
Insusceptibility to disgust.....	—	4.9	—	2.7	4.1	1.0	0.5	0.7
Incontinence <sup>3</sup> :								
Urinary: present..	—	[2.4]	—	[2.7]	[2.5]	—	[1.0]	[0.5]
past.....	—	[4.9]	—	[4.1]	[4.6]	[1.0]	[1.5]	[1.2]
Fecal: present....	—	[4.1]	—	[1.4]	[3.0]	—	—	—
past.....	—	[6.5]	—	[2.7]	[5.1]	[0.5]	—	[0.2]
Total.....	10.5	95.4	12.3	80.0	100.6	24.5	14.0	19.2

<sup>1</sup> Among delinquents, tendencies here include practices as well as inclinations. Among non-delinquents no actual homosexual practices were encountered.

<sup>2</sup> Strictly, a relative insusceptibility to pain is a sensory rather than an emotional deficiency; but few of the non-delinquents were tested on this point. It is included here for convenience.

<sup>3</sup> Incontinence is included here because, in the instances specified, it seemed due to some emotional condition—apathy, laziness, relative insensibility to disgust—rather than to any physical cause. The figures, like all bracketed figures, are not included in the totals.

*The Foundations of Character* (1914), Book II, "The Tendencies of the Primary Emotions"; Drever, *Instinct in Man* (1917), Chap. vii, "Classification of Instinctive Tendencies of Man." See, however, Thorndike's criticism of such lists in his *Educational Psychology*, Vol. I, "The Original Nature of Man" (1913); and the rejoinders by McDougall (*Social Psychology*, preface to latest edition) and Drever (*loc. cit.*, pp. 154-5). The philosophically minded reader may also consult with profit J. Dewey's *Human Nature and Conduct* and E. Faris's critical paper on the question "Are Instincts Data or Hypotheses?" (*Am. Journ. Sociol.*, XXVII (1921), pp. 184-96).



To establish the hereditary nature of any impulse considered as possibly instinctive, we must fall back upon four or five criteria: first, its spontaneous manifestation in the tiny child apart from training or experience; secondly, its spontaneous manifestation in the lower animals, particularly in those nearest to man; thirdly, the possession of bodily organs or appliances subservient to the impulse—for nature, when she equips a creature with a particular apparatus, endows him also with the power and wish to wield it; fourthly, the manifestation of the impulse in different races with different degrees of intensity, inexplicable by mere custom or tradition; and, last of all, its manifestation with an exceptional degree of intensity in various members of the same family, particularly where the members have been brought up apart from mutual contact, and therefore without the means to influence each other by example or instruction.

### 1. Hunger

The animal origin of certain human impulses is seen most plainly when we consider the nature of our universal appetites—those, for example, which impel us to seek food and drink.<sup>34</sup>

---

<sup>34</sup> Appetites are by some classed apart from ordinary instincts (*e.g.*, by Drever, *Instinct in Man*, Chap. xi, pp. 246 *et seq.*). They are more dependent upon internal and intermittent bodily states than upon the presentation of an external stimulus. It is true that the sight or odor of a palatable dish makes the mouth (as children say) water, but it is the literal emptiness of the stomach that in the main promotes that cumulative uneasiness only to be assuaged by the reflex swallowing of food. Thus, to the plain man, appetites in their nature seem more physical than psychical. But the distinction at most is but a matter of degree. Shand, for example, classes hunger and thirst, like sex, with the human emotions ordinarily designated as such (*op. cit.*, p. 28); and McDougall protests against any sharp disjunction (*Outline of Psychology*, p. 103).

Among other so-called appetites are sometimes placed the need for exercise, for air, and for sleep. To the same general group belong also, in my opinion, a pair of additional impulses seldom named in this connection, to wit, the two excretory impulses. These, both directly at an early age and indirectly at a later, become, as every student of childhood knows, associated again and again with petty acts of juvenile naughtiness and may prove centers of perverted interests. In the simple, or the seemingly simple, forms of incontinence, a child's excretory

Here it is patent and beyond dispute that the most powerful of all human motives may spring from a physiological mechanism and serve a biological need. Hunger, among starving men and famished nations, has, in the past, inspired the most lawless deeds. Today, in all but the poorest homes and among all but the most voracious, the daily need for bare nourishment is satisfied with tolerable fullness. Among a few juvenile offenders a natural greed or gluttony may prove the incentive for an occasional crime. But chiefly it is an acquired taste for sweets and dainties, and at a later stage for alcoholic liquors, that leads to these simpler forms of theft and depredation.

I have noted, in my tabulated series, but one case in which an excessive or gluttonous hunger could be regarded as the chief source of a child's offenses. In about 9 per cent, however, it seemed a contributory cause, the cases being more commonly those of boys than of girls (Table XVII).

## 2. Sex

Of the general view that I wish to enforce, by far the most convincing illustration is to be seen in the chronicles of sexual vice and crime. Sexual activities, by general consent, are ascribed to the working of a specific animal instinct, a propensity with which every man or woman, however chaste or civilized, is indefeasibly endowed. In the strength with which they inherit this instinct, races differ, families differ, and individuals differ. In one it is the most frigid of all his feelings. In another it is an urgent and importunate want, as inexorable as thirst or the necessity for sleep. With persons of this latter class—particularly with the over-developed girl after puberty—the physiological predisposition is hardly to be mistaken,

---

habits may even constitute the main ground of complaint (see Table XVII, also Table XXI, under "Anal and Urethral Complexes"). Vomiting, which may be classed as a third excretory impulse of more anomalous kind, has remoter associations of a similar type, and perhaps, in the form of nausea, comprises the germ of disgust (see page 459). Finally, it may be remarked that such cravings as those for tobacco, alcohol, sweets, and drugs, though popularly spoken of as habits, may, alike in their intrinsic nature and in their relation to crime, be regarded as acquired appetites.

legible often at a glance from every curve of her form and every motion of her body. Quite commonly, too, in others of the same family there is a tale of similar misconduct. External factors may, of course, connive; and the influence of negative conditions—unsatisfied affection at home or inadequate control during the spare hours of leisure—should never be overlooked by the investigator. But of the inner working of the delinquent's own mind no further explanation seems required. It is a part of his animal nature, of his inborn physical and mental constitution, so to crave and so to act. An exaggerated sexual instinct suffices to account for all.

Every worker among adolescent girls, and, I suspect, the more watchful of those who work with adolescent boys, could cite innumerable cases where recurring sexual delinquency or unusual sexual vice seems manifestly the outcome of an over-active sexual impulse. But, in most of the more ordinary instances, it is hard to prove beyond dispute that the excess is innate: the early history is too imperfect, and the influence of others equally over-sexed within the same family circle may have been exerted as much through silent example or positive encouragement as through direct biological transmission. In the case that follows, however, the basic factor appears undoubtedly to have been an inherited predisposition.

A young girl of thirteen<sup>35</sup> was brought to me as "beyond

<sup>35</sup> Emmeline O. Age: 13½. *Home Circumstances and Family History*: see text.

*Physical History and Condition*: Whooping cough at 4; measles at 7. Present health, excellent. Height, 157 cm.; weight, 49.8 kg. Menstruation started at 11.3.

*Intelligence and School Attainments*: Mental age (group tests), 17.0 (mental ratio, 131). Reading, 16.0. Spelling, 13.5. Composition, 15.0. Arithmetic, 11.5. Handwriting, Drawing, and Handwork, about 12.0. (The backwardness in the last four subjects due partly to poor teaching at a private school.) General information, 15.0. Considerable ability in singing and elocution.

*Temperament*: The girl's natural suavity of manner and almost unnatural composure of mind had deceived both her school mistresses and every one of her relatives except her mother. Ordinarily, she bore herself with an air of self-contained serenity proper to a young lady under the eye of the world. But, behind this mask, her mind was wildly active. During interviews she was manifestly excited yet able to master

parental control." Dark-haired, dark-eyed, of a deep complexion and a full, rounded figure, she looked to the casual eye to be at least sixteen. After some interrogation, I learnt from the mother that the child, though truthful and obedient in all other respects, would absent herself from home periodically for long hours in the evening, and spend those hours, according to rumor, casting about for male acquaintances, consorting by choice with colored men of an oriental race. The family were all highly respected members of the neighboring church; and it was only by slow steps that I discovered, what hitherto had been kept from the girl herself, that alike on the father's side and on the mother's there were strong sex tendencies. The father was a well-to-do solicitor whose business took him to provincial towns, where from time to time he was admittedly unfaithful. The mother had been reputed something of a flirt before her marriage. Afterwards she had settled down to producing a fraternity of eleven children, of whom all but three have since gone abroad. Of those who remained in England, the eldest, a young woman of twenty-one, had suffered two miscarriages before marrying, had later wedded a handsome but penniless artisan, and had given birth to a child six months after. The next, a dissolute young bachelor of eighteen, had suffered from at least three attacks of venereal disease. The third was the girl now under discussion—the youngest of them all. I found, as time went on, that the eight abroad had reputations to match, and that aunts in both branches of the pedigree had found themselves in similar quandaries. Owing, however, to the varying fortunes of the family, the child I was called to examine had been thrown into no close contact with her other relatives and had been

---

her excitement. She would talk fast and flush quickly, but contrived to give to all her remarks a tone of forced fortuity. She was less artificial when her mother was out of the room, and by laughing away her screen of bland decorum, it was easy to make her reveal herself as by nature she really was—assertive, unstable, and eminently unrepressed.

Her physical appearance, besides the many slight but significant indications in her glance and voice, suggested, almost at first sight, an endowment unusually over-sexed. And it may be added that, in her periodic outbreaks of flirtation, a rough monthly rhythm seemed traceable.

brought up under the careful superintendence of her outwardly conventional parents.

Nevertheless, the mother recollected that, even as a baby in arms, the child was, as she put it, "always too, too affectionate," taking a fervid pleasure in voluptuous embraces. Time after time, from four years of age to seven, she was caught in various modes of self-abuse. Later on, there was a complaint from an elder girl—a cousin who had slept with her—of inclinations seemingly homosexual. At eleven, she was already a notorious coquette—powdering her nose, blackening her eye-lashes, rouging her lips, and shamelessly striving to draw masculine glances wherever she moved.

Several measures were adopted, and the cumulative result of all appears to have been successful. First, she was provided with fuller outlets for her abounding physical energy; she was allowed and advised to join hockey clubs, net-ball teams, and, later, parties for tennis. Secondly, she was induced to take up certain artistic pursuits, such as might offer an opening for her overmastering taste for admiration and display—singing, dancing, and amateur theatricals. Thirdly, being a girl of supernormal ability, with wide, intellectual, and even philosophic interests, she was aided in improving her general education and culture by various plans, particularly those that might fit her histrionic leanings—attending theaters instead of revues, picture galleries instead of picture palaces, Queen's Hall concerts instead of music halls, and reading the plays of Galsworthy and Bernard Shaw instead of the romances of Victoria Cross. Fourthly, in every one of these activities she was encouraged and even urged to preserve male companionship. Taboos were withdrawn, and her parents, not indeed without some intercession, gave free consent to her bringing to the house any man or youth, whether friend or stranger, whose acquaintance she desired. Finally, the task of full sex enlightenment was undertaken by the family physician, and at about the same period, since a chance disclosure brought a fitting opportunity, a complete and candid recital was placed before the child of the troubles and tendencies of the several relatives who labored under temptations akin to her own.



The facts I have summarized were not learnt at a single sitting, nor were the measures I have enumerated set in motion all at once. For nine successive years, through the mediation of personal friends, I have now been in continuous touch with the family. With much ebbing and flowing, after numerous philanderings and not a few premature betrothals yet without any dire catastrophe such as had been foretold, the girl has steadily won her way from a life of defiance and deceit to an honest career, and is now, at the age of twenty-two, a young actress of promise, the sole support of her widowed mother.

Among my two hundred delinquent cases, I trace the offenses alleged to an over-potency of the sexual instinct in as many as 16 per cent. In about 2 per cent of the boys and in nearly 7 per cent of the girls this was the sole, or at least the chief, contributory cause, and the offenses themselves were sexual. In the remainder, where the sex instinct played a secondary part, the offenses were quite often not of a sexual, but of a so-called substitutional type, and the instinct, partly or wholly repressed, acted usually through the formation of some hidden complex. Whether operating as a principal or as an accessory factor, the effects of this instinct seemed far more serious, or at any rate were brought far more frequently to notice, among girls than among boys.<sup>36</sup>

A word or two of caution, must be added. In its minuter details, the popular psychology of the sex instinct is grossly incomplete and deplorably inaccurate; and many of the gaps and inexactitudes may prove fatally misleading to those who have to do with childish misdemeanants. To begin with, the traditional doctrine that the sex instinct in man does not emerge

---

<sup>36</sup> This may be due in part to some inherent sex difference. Hyper-sexualism seldom shows itself so early in youths as in girls, and in girls is apt to color and dominate the whole of their life's interests in a way it seldom does in men. But in part the difference between the figures is a superficial one. Open sex offenses form the ground of anxious complaint much more commonly against girls than against boys, and since among boys unrepressed sex instincts may thus vent themselves with comparative impunity, boys suffer less often from those complexes and substitutive outbreaks that arise from repression.

until the crisis of puberty is demonstrably wrong. Freud, as is notorious, has called attention to immature manifestations existing from the earliest years of infancy. And even Freud himself seems to slip into a kindred error when he implies that, during the so-called "period of latency"—a period roughly conterminous with the elementary school career—the sex instinct lies dormant and inactive.<sup>37</sup> Tiny children still in the infants' school, and therefore barely six or seven years old, often perform aggressive actions towards each other of a decidedly sexual cast. Many school mistresses, believers in the accepted innocence of infancy, either ignore these unlooked-for exhibitions or regard them as grim symptoms of moral depravity, affecting none but the abnormal. Both attitudes are equally mistaken. These little boys (for, at such tender years, in contrast to the later, it is boys more often than girls who are the subjects of complaint) inherit an instinctive interest shared by all other children, and when this interest is displayed with premature and persistent strength, there is frequently discoverable an hereditary excess handed on from one or both of the parents. The child is the victim of a natural propensity unnaturally precocious.

A second misconception has similar currency. The sex instinct, when the proper time is reached, is supposed to burst abruptly forth, already perfect and precise, a single simple procedure for the sole purpose of propagating the race. On the contrary, at any rate in man, it is a thing singularly vague, incomplete, and heterogeneous. Simply to note the numerous and divergent forms of sexual delinquency is to see that this so-called instinct must be in fact a composite cluster of instincts, covering far more than the mere semi-reflex act of mating. It unfolds, especially during the younger stages, into an incongruous coil of partial and subordinate tendencies—variously excited and differently expressed—each of which may lead to its own special mode of misbehavior. And here once more, in ignorance of the psychological facts, teachers some-

---

<sup>37</sup> *Introductory Lectures on Psycho-Analysis* (Engl. trans., 1922), pp. 274 *et seq.*

times miss the deeper implications of minor symptomatic practices.<sup>38</sup>

Again, the sex instinct may combine as well as disintegrate. Often, as we shall presently observe, it blends with other instincts, and the union may issue in childish habits which may be heavily but unjustly punished from a false belief that the sole motive is some horrible perversion of a lewd or licentious caprice. Of these, the commonest at the earlier ages are those monkey tricks in which the instinct of curiosity or the instinct of display excites inspections or exhibitions, all wrongly referred to downright sexual nastiness.<sup>39</sup> At the later stages, both during and after the crux of adolescence, much flirting, fondling, and embracing are, we shall find, the outcome of the hunting instinct (especially in youths) and of the mothering instinct (especially in older girls), rather than of sheer unadulterated sensuality.

### 3. Anger

Next to the instinct and emotion of sex, the instinct of pugnacity or combat, with its concomitant emotion of anger or

---

<sup>38</sup> The topic is too delicate to be pursued in greater detail here. To make the practical import of my meaning clear, however, I may draw attention to the frequency with which elementary school teachers misinterpret obvious indications of open self-abuse among girls and of homosexual practices among boys. In the infant, habits popularly described as unnatural are just as natural as those that are universally conceded to be such. That these erotic tendencies of childhood are by no means isolated or peculiar, but are often the forerunners of excessive heterosexual misdemeanors, is not always realized.

<sup>39</sup> It should be added that many of the habits to which school children are sometimes addicted and which are commonly reported as sexual are really perversions of the excretory rather than of the reproductive processes. The two types of dirtiness should not be confused. The excretory interests develop, as we have seen (note 34, page 408), out of a couple of physiological impulses which are as essential to the life of the individual as the sex impulses are to the life of the species. These different sets of impulses, the sexual and the excretory, are confused together in the popular mind because, by some singular muddle of nature, both of them involve the same or closely adjacent organs; and thus they arouse, almost equally in most of us, the restraining instinct of disgust. It is, indeed, with this last instinct of disgust that the excretory interests get mainly bound up far more than with the instinct of sex in the narrower sense of that term (see page 458). Often, how-

rage, is probably the most widely recognized. Throughout the human race, as throughout the animal kingdom, to fight is hardly less universal than to mate; and, just as all creatures but the lowest are endowed with special organs of sex, so many of the higher are equipped with special organs for defense and for aggression—the bull with horns, the fighting cock with spurs, the tiger with tooth and claw. Man, when fully grown, being—in the definition of Herr Teufelsdröckh<sup>40</sup>—“a tool-using animal with the gift of speech,” fights now with artificial instruments of violence and now with his tongue. But in the first few months of infancy he is limited to, and in later childhood he still intermittently employs, like all the humbler creation, the members and appendages of his body: he bites and kicks; he scratches and cuffs. And, indeed, so early, so immediate, so obviously unlearned, are all these movements of aggression that they wear the nature of hereditary reflexes rather than of conscious and considered acts.

Not only is the combative instinct itself inherited, but differences in its strength seem demonstrably inherited, too. Certain races, as the Irish, the Italian, and the Red Indian, are reputed to be passionate and pugnacious.<sup>41</sup> In certain families an extreme liability to anger or bad temper appears unquestionably innate; again and again, where a child has been brought to me for violence, assault, or fits of fury, there has also come to light a history of similar traits among his parents or remoter relatives. Some have claimed that the inheritance of pugnacity is sex-limited and that to fight is the peculiar prerogative of the male. But the difference is a difference more of strength and mode of manifestation than of sheer presence or absence: the boy hits out; the girl more commonly screams or sulks. No doubt, in all these instances—whether of race, sex, family, or individual disposition—the inborn susceptibility is but one

---

ever, in actual conduct, the manifestations of all these different instincts become united or merge the one into the other.

<sup>40</sup> Carlyle, *Sartor Resartus*, Chap. v, p. 23.

<sup>41</sup> In schools attended by immigrants from Ireland or South Italy, teachers are always ready to bear testimony to the unusual number of quarrels, blows, and bouts of temper among the pupils in their charge.

of several elements. Tradition, custom, and example are alike contributive. If a child is one of an ill-tempered family, he must be living in a daily atmosphere of squalls and violence, and this association of itself may induce an equal ill temper in the child.<sup>43</sup>

The crimes and delinquencies to which anger may directly lead are classifiable under three main heads: (1) physical violence to persons, (2) angry behavior towards persons, without physical violence, and (3) physical violence to property. Of these, the first includes a wide variety of hostile actions, from killing, wounding, and fighting both with and without weapons, down to mere bullying and the infliction of a single blow; under the same head, too, may be placed physical cruelty to living beings generally—animals as well as children—where the cruelty is an incidental accompaniment of a vicious or vindictive attack.<sup>43</sup> The second group includes abuse, threats, insults, whether by speech, gesture, or the written word, and forms of contentious behavior less sharply definable, such as teasing, quarreling, incorrigibility, and all the subtler modes of mental annoyance.<sup>44</sup> The third and last group includes malevolent or mischievous damage and various acts of destructiveness, such

---

<sup>42</sup> An irritable frame of mind, as already remarked (page 242), rests often on a disturbed condition of the body, and the milder forms of anger—petulance, peevishness, and sensitive fretfulness—appear, in a majority of cases, to be the indirect outcome of physical weakness or of physical irritation. Some go so far as to declare that they "have failed to find excessive irritability without some physical cause" (Healy, *op. cit.*, p. 767). The fundamental agency, however, is still the natural instinct of anger: the physical condition acts partly by robbing the child of firmness and self-mastery, partly by providing him with an abiding situation that gives ground for vague uneasiness and discontent, and thus, in one way or another, keeps continually in a state of sub-excitement a cross, cantankerous spirit.

Storms of violence, apparently motiveless, and moody spells of obstinacy and ill humor are highly characteristic of epileptics; and, in a member of an epileptic stock, who himself shows none of the distinctive physical symptoms, repeated attacks of rage may sometimes occur as so-called "epileptic equivalents." Similar exhibitions form no uncommon sequel to *encephalitis lethargica* (see pages 258-60).

<sup>43</sup> Where the impulse to cruelty seems primary rather than incidental, other factors are usually at work: see pages 451-3.

<sup>44</sup> In official charge sheets and case records the use of the term "incorrigibility" does not of necessity connote angry or aggressive conduct.



as window breaking or arson, so far as they are animated by pique or rage rather than by a spirit of adventure, self-assertion, or cold and calculated revenge.

These reactions are all immediate. The angered person shrieks and hits out at the person who affronts him or smashes whatever lies nearest to his fist. But anger, like sex, may also promote delinquency by mental processes that are roundabout and indirect and so issue in substitutional reactions which on the surface might seem the outcome of some different instinct. An infuriated youngster repressing his first impulse, instead of dealing blows with his knuckles or curses with his lips, may take to stealing, wandering, or staying out late; he may rush out of the house; or he may hang about the home, engaging in a long campaign of minor disobedience and perversity, such as makes his exasperated parents at last declare him unmanageable and beyond control.

The ease and frequency with which anger may inspire delinquency, whether by direct or by indirect reactions, are owing in part to the singular intensity of this passion, but in part they are also attributable to the unusual nature of the situations that are apt to arouse it. All other emotions have their special stimulus, their special form of provocation: there is always some particular object or some particular class of objects which, when perceived, fires off the hereditary mechanism, as a spark set to the right touchhole explodes the connected train. A loud noise awakens fear; pain precipitates weeping; the sight of the opposite sex quickens amorous desires; a nauseous smell or taste evokes disgust. What is the peculiar stimulus, the special sense perception, that kindles the instinct of rage? There is none. The proverbial red rag which, by its mere exhibition, goads on the ferocity of the untamed bull has, in

---

Unwilling to register against the child a conviction for some definitely criminal offense like theft, a magistrate will frequently request the parent to prefer a charge of general incorrigibility.

I should add that, where the annoyance, however varied in character, is consistently leveled against one particular person or type of person, there not a simple and passing emotion of anger, but a complex and permanent sentiment of hate, is more likely to be the underlying source. See Chapter XII.

the case of man, no counterpart. The combative instinct thus differs from instincts more truly typical: it is stirred by no specific object of its own; it is called into play only when some previous impulse, already roused and active, is obstructed or opposed. These preëxisting impulses may be of almost any kind. With lower animals, it is enough to interrupt the creature, while with its food, its mate, or its young: fury is instantly displayed. With man, interference with any eager course of mental action tends to summon up his anger. Anger, therefore, always presupposes the prior activity of some other emotion, and the propulsive energy of the combative instinct, thus secondarily called forth, reinforces and is reinforced by the pent-up energy of the primary and thwarted desire. It is this wide range of excitability, together with this double source of strength, that turns anger, of itself essentially a destructive passion, into the most vehement and the most dangerous of all human motives.

From this it is plain why so many offenses in the young are offenses of primitive violence. Children, from their position of physical and social inferiority, are peculiarly liable to have their childish whims frustrated. Hour after hour, by the adults around them, and by the hard world of fact, their hopes are disappointed, their activities disturbed, their natural wishes defeated or baulked. Hence, since childish behavior still lies so largely upon the instinctive plane, this constant thwarting cannot fail to stir up the spirit of strife in those who possess it, and the wrath of the more irascible is inflamed almost daily.

The angry misdeeds with which school children are commonly charged are, in their concrete nature, very various: the age, the size, and the sex of the offender exert an obvious influence over the manifold ways in which the combative instinct may express itself. The passionate displays which from the second month onwards the smallest infant makes are viewed by every one as no more than instinctive ebullitions and are treated as devoid of all ethical significance. We condone them as "temper"; we correct them as "naughtiness"; we never call them criminal. The actions reported during the earliest days at school are equally crude and brutish. Biting is among the

first. Scratching, hitting, pinching, kicking shins and pulling hair, sticking pins and nibs into the next child in the line, are the commoner matters for report from infants' schools. Even at this tender age, however, such proclivities may take a cruel or a criminal complexion, and it is by no means exceptional for boys of six or seven to evince alarming habits of barbarity and to make vicious little onslaughts with a stone, a knife, or a pair of scissors upon their parents or companions. Little girls of eight or nine are sometimes seized with singular paroxysms of rage. The child will revert to the behavior of a tiny baby in a tantrum, flinging herself on the floor, kicking, screaming, struggling convulsively, and flushing scarlet in the face. Teachers and physicians sometimes speak of these seizures as "brainstorms," or think of them as "fits" of a quasi-epileptic nature, the effect of some organic discharge within the nervous system. Close questioning, however, will commonly reveal that the "fit" is nearly always precipitated by some ascertainable though trifling cause—a slight reproof, a passing disappointment, or an unwelcome injunction from the class mistress. At a somewhat later age, particularly in boys of ten and eleven, criminal malice and mischief get directed more against property and less against persons; and when aimed against persons, anger now appears rather as a defensive and reinforcing instinct issuing in disobedience or defiance and far less frequently as a direct propensity to aggressive assault. As adolescence draws near, however, personal violence becomes commoner once more, and the pugilistic aspect of the instinct reappears in all its well marked forms. Most boys develop at puberty an augmental disposition to fisticuffs. Yet, at the same time, thanks largely to increasing intelligence, there is also evolved a curious half-automatic habit of self-restraint: so that no more than a small proportion of the actual brawls issue in serious injury or in recourse to harmful weapons. The young antagonists set to, like a couple of contentious puppies skirmishing together, where one dog seizes the other by the throat or pins him to the ground and yet no drop of blood is drawn. Never to go too far is now a rule of the game. Such exhibitions have often the deliberate purpose of terrifying or bewildering the on-

looker. Both boys and girls at this stage will sometimes run amuck with all the semblances of a reckless frenzy, and the parent who may be the observer or even the object of the attack imagines that the frantic onsets are really homicidal. Calm attention, however, will be able to discern that, in most instances, the young assailant is almost consciously feigning a mad absence of control and warily abstaining from any actual injury; he hurls the most dangerous missiles about—knives, door knobs, dinner plates, but with a dissembled prudence, covering care in carelessness, takes a bad aim.<sup>45</sup>

With some young people, however, the pubertal moods of anger may assume the form not of desperate fury or wild violence, but of petty petulance or glum and moody sullenness; the child sulks and chafes and mopes. As adolescence is completed, these spells of ill humor, whether rabid or morose, are left gradually behind: and, with the young adult, anger begins to depend more upon outer provocation than upon inner mood. But, since the most usual component is now sexual jealousy, passion becomes once more a possible instigator of dangerous or fatal assault.

Among children who are smaller or weaker than their fellows and among girls, particularly girls of riper years, animosity finds a subtler and a safer outlet than the sheer use of physical force. Injury and assault are rare. Their anger vents itself rather in the modified form of hostile speech and moral persecution. They wound through the feelings, not with the fist. Taunts, insults, false insinuations, all the vexatious slanders that a malevolent volubility can devise become the chosen means of aggression or revenge.<sup>46</sup>

Murder is the taking of human life with malice aforethought.

---

<sup>45</sup> In very young children the power to discriminate and to control what is excessive is undeveloped; in passionate adults it may at times prove ineffective. And, in either case, manslaughter may result.

<sup>46</sup> This seems assignable, not so much to any sex-limited difference in the inherited tendencies of anger, nor solely to the proverbial and well-established linguistic aptitude of the feminine sex, but rather to the inferior size and the inferior muscular strength by which the feminine sex is characterized. Complaints of violent language are, it is true, more frequently preferred against girls than against boys. But here, I

To kill another in the heat of anger or under strong provocation is not murder. Murder, therefore, is never the result of a simple instinctive action. The boy Jerry intended his act to kill and knew that his act would do what he intended.<sup>47</sup> Thus, his crime involved a state of intelligence relatively developed. Most children, when they talk or think of killing (and they very often do), have but a dim and shadowy notion of what death means. Sometimes quite tiny infants startle their parents and their teachers by the outspoken vehemence of their threats. "I wish you were dead," or "I'd kill her," are no rare expressions on the lips of a little child.<sup>48</sup> Yet of what may or

---

conceive, the sex difference is apparent only. Mothers and women teachers who have the oversight of girls are more likely to be distressed by coarseness and profanity than are fathers and men teachers, and both men and women consider such offenses (and rightly so) as constituting a graver ground for solicitude when occurring among girls.

<sup>47</sup> Some may think that, in using the word "murder" of the acts of Jerry and other small children, I am unwarrantably applying too harsh a term. Jerry, however, was over seven; and, young though he was, it is a legal maxim that *malitia supplet aetatem*—that the presence of a malicious intent makes up for lack of years. In abolishing the death sentence for children and young persons, the Children Act (Sec. 103) clearly contemplates that a child may be convicted of murder in the future: in the past, a boy of ten has been so convicted and hanged (Fitzherbert's *Reports*, tit. Corone, 118, *cit. ap.* Hale, *History of the Pleas of the Crown*, Sec. 25). Nowadays, however, in actual practice, it is highly probable that the Court would decline to attribute the necessary malice aforethought to a young child and would sum up the case to the jury as one of manslaughter. (This, in fact, was recently done: see *R. v. Kershaw*, *Times Law Reports*, XVIII, 357.) Barely two years ago, a lad scarcely eighteen was sentenced to death (Henry Jacoby, executed for the murder of Lady White, June 8, 1922), and in the preceding year a boy of fifteen (Harold Jones, sentenced Nov. 2, 1921) was ordered, in accordance with the new provision of the Children Act, to be detained during His Majesty's pleasure—the boy in this case pleading guilty to two murders "lest other consequences should ensue" if the trial went on till he was over sixteen.

In the case of a tort or actionable wrong, as distinguished from a crime—for example, damage or destruction done under a passing wave of anger—there is no rule analogous to the presumption of the innocence of young children in respect of any criminal charge; since, in the matter of civil injury, *mens rea*, a guilty or malicious motive, need not necessarily be proved. It is hardly likely, however, that a child would be held responsible for a want of greater care and self-control than might be reasonably expected in one of his age (*cf.* Beven, 3rd ed., i, p. 45).

<sup>48</sup> The bloodthirsty words themselves are nearly always picked up from



may not be fatal, children are strangely ignorant. Readers of William James will call to mind the classical case of Jesse Pomeroy, who cut a little girl's throat "just to see what she'd do." In another instance, a country girl of five, having one day with great interest watched her father slaughtering a sheep, said to her young brother afterwards, "Let's play killing baa-lambs," and making him lie on the floor, proceeded to slash his throat from ear to ear, so that he died. Killing to the tiny child means usually two things: first, in its method it is merely the most thorough form of personal retaliation that he has heard of, and, secondly, in its result it simply implies the complete removal of the unwanted person once and for all. As Freud has pointed out, the death wish is singularly common among the young, and connotes, as a rule, no more than a desire for its object to be out of the way.<sup>49</sup>

In spite, therefore, of the early use of murderous threats and of many authentic cases where children of four or five have taken life in a burst of fury, I cannot accept the view of some writers that to kill is the natural end of anger.<sup>50</sup>

In my group of analyzed cases, anger or pugnacity appeared to be the main factor with less than 2 per cent—0.8 per cent among the boys and 2.7 per cent among the girls. In nearly

---

some older person: "I'll half kill you when I catch you," is a threat to be heard at any time of the day in any London slum and promises no more than a smarter slap than usual.

<sup>49</sup> *The Interpretation of Dreams* (Engl. trans., 1913), pp. 218 *et seq.*

<sup>50</sup> Mr. Shand speaks of "a primitive variety of anger of which the end appears to be to destroy life"; and adds that, in many animals—as, for example, in the *Felidae*—"killing is the end, whether there is or is not resistance" (*Foundations of Character*, pp. 226 and 227). But the instinctive killing carried out by carnivorous creatures is part of the hunting rather than of the fighting instinct, and the victim's death is but the incidental consequence or the necessary preliminary to devouring him. In man, the combative instinct as such is satisfied when opposition is beaten down—when the opponent retreats or is stretched motionless and powerless on the ground. If by the blows given during the attack or by the continued battery of the fallen foe under the persisting violence of the mood, he happens to be done to death, this ultimate result is not the essential aim of the original blind impulse. Deliberate murder for revenge is, of course, far from being merely instinctive; it presupposes a conscious resolve to punish outright and to end opposition forever.

all of these instances the offenses were of the nature of recurrent fits of stormy temper, accompanied usually by open assault. As a subsidiary factor it was far more frequent, particularly among the girls—commoner, indeed, than any other instinct except that of sex (Table XVII).

The following may be offered as an illustrative instance. It is one where offenses of the sort just enumerated seem to flow almost entirely from an inherited intensity of this particular instinct. A girl was brought to me charged, like the last case, with being "beyond parental control." She was named, most inappropriately, Irene; peace was the last quality to which she could lay claim. A big, burly, fierce-looking maiden, with a puckered scowl on her forehead and a square, undershot, resolute jaw, she shouldered into my room with a policeman's blood literally moist upon her knuckles. Her history had been self-consistent all through her thirteen years of life. Almost from the hour of birth she had shown a passionate temper. Her babyhood was punctuated with recurrent transports of screaming. In the infants' department she was known for a little spitfire, and tales were still remembered telling how she had pinched, and pushed about, and on one occasion even stabbed, the other children. Similar scenes were renewed in every classroom of the upper school. As she grew older and stronger, so her quarrelsome habits became more formidable. Her crowning outrage was a vicious tussle with her mother, which she terminated by knocking out, with a single blow, two of the woman's incisor teeth. There were, besides these open acts of violence, other and smaller offenses—a couple of thefts, several bouts of truancy, and a good deal of willful destruction. But each of these successive outbreaks was assignable to the same overruling motive. All were demonstrable of hostility and defiance.<sup>51</sup>

She was one of the numerous cases in which a nearer inquiry

---

<sup>51</sup> Irene P. Age: 13 $\frac{1}{2}$ . *Home Circumstances*: Father, boxer, said to have had occasional drinking bouts; died of cirrhosis of liver. Mother, charwoman (earning about £1 per week); quiet, careworn, but apparently respectable. Two rooms, untidy but not dirty (rent 6s., pre-war).

*Family History*: Father's family, Irish and choleric (see above).

showed that the child's pugnacity was in fact a family trait. Her father was a man of choleric moods, and, comfortably enough, his occupation was that of a professional boxer. Most of the male members of his stock were of a fighting disposition. Several had enlisted in the Army after implacable quarrels at home; one, a paternal uncle, was in an asylum as a homicidal maniac. They were Irish and lived in Belfast. Hence Irene had never been in contact with them. Her father had died before she was five. Of his character she apparently knew nothing, and could hardly have been influenced by his example.

Except for her moods of rage or sullenness, it was generally allowed that Irene was an exemplary child. Of ability she had more than the average. At her lessons she was diligent and exact. In the senior class she rose at last to be a prefect, and there, despite her fierce and fiery methods, she won the hearts of all her fellows by her prowess in hockey, in swimming, and in the matches of her school.

Had she been a boy, these and similar sports might have offered both an outlet for her combativeness and a lesson in self-restraint. As it was, such safety valves, though freely provided, brought but little relief. With her the reformation arrived by another path. The first step was to make her angry and indignant with herself, and, with tact and ingenuity, it was not hard to contrive situations which secured this issue with some frequency. The next stage arrived without any intentional arranging. There chanced to be in Irene's class a down-trodden little weakling, much bullied by the other girls, who perhaps had set themselves to copy the pattern of their prefect.

---

Mother's family, dull, but healthy. Mother has had two miscarriages; one child died in infancy. No other children.

*Physical History and Condition:* Measles, whooping cough. Wassermann blood test negative. Slight hypermetropia. Height, 155 cm.; weight, 46.2 kg. (approximately those of a girl of 15).

*Intelligence and School Attainments:* Mental age, 14.0 (mental ratio, 103). Reading, 12.7. Spelling, 12.8. Composition, 12.0. Arithmetic, 13.5. Handwriting, 12.5. Drawing, 13.0. Handwork, 13.5.

*Temperament:* Violent tempered (see above). Somewhat unstable and unrepressed. Slight "father fixation" possibly determining the ultimate course of her affections.

The climax came one afternoon in the park, when during a squabble this child was pushed into the lake. With great bravery Irene dived in and rescued her, and the glory that she reaped, together with a dawning sense of the widespread influence of her bad example, did more than anything else to transform her general conduct.

Her after-history is worth recording, since it shows how the reformation of an inherited tendency, though apparently successful for a period of years, may break down again under a renewal of stress. Irene's cure was far from permanent. At the age of twenty-one she married a young guardsman whose own pugilistic leanings made him something of a hero in her eyes. After a month or two of married life, both of them, wife and husband together, took to drinking. Their savage instincts were once more unloosed, and life has become for them little else but a continuous wrangle. Perhaps, if ever Irene becomes a mother, tenderness will prevail over temper. Perhaps, if her child inherits her failing, the history will repeat itself, and the family ferocity will be handed on again to one generation after another.

#### 4. Acquisitiveness

In the older inventories of human instincts, the acquisitive impulse finds no place; neither does any conspicuous nameable emotion stand with it in obvious correlation.<sup>52</sup> Nevertheless, more recent exponents, men of scientific caution, like James, McDougall, Rivers, and Drever, have expressly recognized acquisitiveness as a true instinctive tendency; and McDougall, applying his two customary tests, points out that the impulse to appropriate, collect, and hoard, is found in a prehuman form among such creatures as the jackdaw and the squirrel and in a pathological form among asylum kleptomaniacs. We might add that, if popular psychology is to be trusted, certain peoples, as the Jewish and the Scottish, seem endowed with an acquisitive disposition to a degree unusually high, and evidence, less fa-

---

<sup>52</sup> In speaking of acquisitive boys, the words "greedy" and "greed" (which etymologically refer to hunger) seem used at times to denote some such emotion. See page 429).

miliar but more worthy of credence, seems to argue that some primitive races—as the hunting and pastoral nomads—neither possess, nor yet can cultivate, a common human propensity, which in other races forms an indispensable basis for their commercial civilization and their industrial success. From time to time, too, families are encountered whose history seems to make it clear that, in many of their members, the acquisitive passion is supreme; while other families seem constitutionally improvident, and, although in most matters sufficiently far-seeing and circumspect, are devoid of all interest in earning, saving, or accumulating wealth. Here, however, family tradition plays its inevitable part, and the proof of heredity is anything but conclusive.<sup>53</sup>

Many animal species are equipped with what might be termed an acquisitive organ, a member, often highly specialized, for the purpose of prehension, like the forepaw of the squirrel and the claw of the eagle. Man and the tribe of apes and monkeys are unique in the dexterous prehensile instrument which has been bestowed upon them by the evolution of the hand: these creatures, accordingly, have become thieves and acquirers *par excellence*. In humbler animals the instinct of acquisition is primarily subservient to the lowly appetite of hunger: hence, most of them snatch what they want with their mouths; and the appendages of the mouth, as the jaws or the beak, become specially adapted for seizing as well as for biting. Thus armed, the bird or beast will use its power of appropriation, not only to satisfy its stomach, but also in the service of other natural needs, and sometimes needlessly. The raven and the sparrow peck up straw and feathers for their nests; the jackdaw and the magpie will take anything they can, and simply for the sake of taking. Here, then, we are not fallaciously inventing an abstract faculty to explain a concrete fact, a hypothetical propensity to steal to account for the act of stealing: we seem confronted beyond all doubt with a definite

---

<sup>53</sup> It is, indeed, the exception rather than the rule to find more than one thief in the same family. Stealing, however, hardly bears the same intimate relation to the instinct of acquisitiveness as violence and sexual misconduct do to the instincts of anger and sex.



physiological mechanism and a demonstrable instance of biological transmission.

In the baby, grasping things with the hand is one of the first reflex movements to emerge. And among tiny children the connection of this grasping reflex with the appetite of hunger is both obvious and suggestive. Any small article within range of the child's eyes and within reach of his fingers, and with a color or a brightness to arrest his attention, will be clutched in a twinkling and conveyed directly to his lips. It is, therefore, no matter for surprise that, with almost every young plunderer, the earliest thefts prove to have been thefts of food. Here lies the germ, or at least the primary constituent, of the acquisitive instinct in its human form. And, in the petty pilferings of young defectives, like the feeble-minded boy described above,<sup>54</sup> little more than these semi-reflex impulses to grab are working.

The instinct of acquisition, however, includes another impulse besides the plain tendency to snatch and seize. Many animals, even among the lower species, take what they want, not for immediate use, but for consumption later on, and in the interval store what they have pillaged. The squirrel will bury his nut instead of nibbling it up forthwith, and the dog will inter his half-gnawed bones. This depositing of the spoil so soon as it has been picked up can be of little service unless the place where it is stored is safe and therefore secret. There seems, accordingly, a special hiding impulse, evolved as part of the instinct to acquire.<sup>55</sup>

A third tendency may be distinguished. Creatures that steal and store tend also to collect. This perhaps, in its simplest

---

<sup>54</sup> Harold J. (page 288).

<sup>55</sup> Note that this secretive tendency is quite distinct from the stealthiness of fear; the latter prompts the coward to conceal himself whereas the former prompts the prudent raider to conceal his booty. It may be remarked that the methods adopted by animals like the dog for secreting their food are almost identical with those adopted by them for concealing their excreta. This possibly provides a basis for the connection noted by psycho-analysts between the so-called anal complex, on the one hand, and habits of hoarding, collecting, and miserliness, on the other. Indeed, it suggests that the secretiveness of acquisition is akin to the secretiveness of disgust and shame more than to the secretiveness of terror.

form, is due solely to repetitions of the same instinctive action, together with habitual recourse to the same selected hiding place: to take and deposit, and then take and deposit again and yet again, is at length to accumulate a hoard. In London elementary schools, statistical inquiry shows that few boys pass through their 'teens without making collections of one kind of object or another—stamps, marbles, cigarette cards, shells, eggs, and so forth—usually without the least ulterior aim,<sup>56</sup> and no small amount of the pilfering of the town child is, like the bird's nesting of the country youngster, the outcome of this whim for collecting.

Here, indeed, we begin to discern a correlated emotion. In its other forms the acquisitive tendency is cold, calm, and almost empty of all feeling; it knows nothing of those pulsating paroxysms that animate the instincts of anger and of sex. The dull pangs of covetousness, the lukewarm passion to possess, the envious ache that we sometimes designate as greed, these are the nearest approaches to an acquisitive emotion in the usual exercise of the underlying instinct. But where the collecting tendency begins to operate the avaricious thrill grows stronger. The feverish glee of the miser, as he lays by his coins and counts up his clinking treasure, is proverbial; to Silas Marner "it tasted like the satisfaction of a thirst"; and the small boy's glorious rapture as he gloats over his piles of pearl buttons or brass badges is equally irrational and no less intense. Generally, however, in these ecstasies, something more is in action than a mere instinctive impulse. The boy collector and the aged skinflint, Huck Finn and Harpagon, have developed what the psychologist calls a "sentiment"—that is, a permanent passion of love—for whatever articles they are amassing. Into such a sentiment of ownership, both the acquisitive instinct and the emotion of possession doubtless enter as indispensable and original ingredients; seldom are they the sole source of the desire.

---

<sup>56</sup> See, for an interesting study of the collections made by boys and girls, the chapter by Caroline F. Burke on "The Collecting Instinct," and her appended bibliography, in S. Hall's *Child Life and Education* (1907), pp. 205-240.

Acquisition, then, in its purest form, is of all human instincts perhaps the least emotional; that it should actuate the commonest of human crimes becomes, in consequence, a strange anomaly. In one shape or another, stealing accounts for 80 per cent of boyish transgressions. To attribute all thefts as such solely to an acquisitive instinct would, of course, be grossly to oversimplify. Indeed, in only 1.6 per cent of my cases, all of them male, have I been led to assign the child's delinquencies to sheer inborn acquisitiveness. With the bare exception of the imbecile or feeble-minded, a child who is old enough to steal is generally old enough to frame a conscious wish for the object to be stolen or purchased with the stolen cash and, moreover, to realize that robbery is wrong. The energy that drives him to his crime springs from some deeper incentive than the mere automatic movement to clap hands on whatever strikes his fancy. Here, therefore, we have commonly to do with a dependent or derivative impulse, one instinct working in the service of another: the child steals to satisfy an instinctive hunger with food or sweets, an instinctive vanity with ribbons and bracelets, an instinctive resentment by a wanton vexation of the victim of the loss. At an older age still, the ultimate motive may be, not an instinct at all, but a full-grown sentiment—a passion for the picture palace, a love of jewels or finery, or a resolute hostility to the person robbed. But, even in the oldest and most intelligent offenders, we must beware of too hastily assuming that the commodity purloined is beyond question a commodity consciously wanted. It may possess, as we shall learn later on, a value purely subjective, perhaps some quaint symbolical significance, and in most cases the more intelligent the thief, the more intricate and intertangled are his motives likely to prove.

In many of these more complex cases the thieving commences simply as a substitutive reaction for some other impulse, barred, balked, or suddenly frustrated. How is this singular transposition to be explained? Why should a boy who is furious with his mother for loving the baby better than himself incontinently start filching from the counters and barrows, with money all the time in his waistcoat for a straight and honest

purchase? There lies, in this odd inconsequence, one of the many enigmas of criminal psychology. The problem is—not why does one mischievous outlet serve for another that is blocked but why is the substituted safety valve almost inevitably that of theft? Of all the available instincts, why should acquisition in particular appear so repeatedly as the vicarious offshoot of mental perturbations of an entirely different kind? I can only throw out, as a suggested solution, an analogy from other derivative impulses. Any emotion once set going, if it have no object or have lost its object, tends always to find for itself some object of its own, to get, as it were, some workable point of application, some channel through which it may discharge. Now acquisition, like anger, is essentially an instinct for coping with an obstacle; it is nature's device for procuring what one needs but does not possess. Thus, like anger, it readily appears as secondary to some other desire. Once, however, it is launched fully with its own momentum, this covetous craving behaves like other moods and humors—like grief, ill temper, or anxious apprehension: it is liable to break loose from its real root or origin; and, like a floating weed, to fix and fasten itself parasitically upon almost any concrete substitute, however irrelevant, however illogical, that may chance to offer it some palpable hold. Mary, aged nine and mentally defective, locked out of the kitchen at dinner time, roams the house, and lights upon a set of amber beads to carry off and play with. John, in a similar predicament, steals marbles from other boys, doubtless in lieu of their luncheon. Harry, a dullard of sixteen, rejected by his youthful sweetheart, goes straight from his wooing and commits his first burglary: "I couldn't get *her*," he explains, "so I got old Ikey's cashbox"—as if the connection was obvious; indeed, to the psychologist I think it is. It is the pent-up energy of the thwarted appetite that adds strength to the alternative quest which the thwarting of that appetite has itself indirectly provoked.<sup>57</sup>

---

<sup>57</sup> Nellie stealing her mistress's heart-shaped locket when she could not gain her love, Vivian stealing his classmates' spectacles when he could not acquire their knowledge of Greek, are perhaps, to some degree, examples of the same illogical procedure; but with them revenge

In the older thief, whose intelligence is average or nearly so, cupidity may have behind it a yet more intricate machinery. It is peculiar to the acquisitive instinct that its workings are essentially progressive. Fright, rage, sorrow, and sex, all the other emotions, indeed, except perhaps curiosity, rise swiftly to their point of saturation; they then suddenly sink down like a punctured bubble, or at most go circulating time after time along the old unwidening groove. With acquisition it is different. The very nature of acquisition is a cumulative process. It touches no limit; it knows no satiety. Here lie its greatest social value and its greatest social danger. It is, I believe, this unique, expanding character, together with the derivative origin already remarked upon, that conspires to make the acquisitive instinct responsible for four-fifths of all juvenile crime.

These points are of practical significance alike for diagnosis and for treatment. To begin with, the investigator must be prepared to find that the case history of the thoroughgoing thief is almost invariably long, elaborate, and involved. As a rule, the escapade which has at length unmasked him proves but the last item in a long tale of similar but more successful ventures. His secret career, on further analysis, pulls out, like a telescope, into successive stretches of unsuspected pilferings, each a little bolder than the last. He began, perhaps, at the age of six with the unrebuked filching of food from the pantry; he advanced, by gradual and well-defined stages, to the purloining of pennies at home, the looting of stalls in the street, the lifting of goods from shop counters; and his exploits soon culminate, now perhaps with an accomplice, in a set of methodically planned depredations—pawning household furniture, burgling houses or schools, and forging signatures to bank books and checks. The type of theft to which the delinquent is at the moment addicted may be of deep diagnostic import. It indicates the stage so far attained on the progressive ladder of crime. To steal money shows greater forethought than to

---

partly supplements envy. To those who think my interpretation a mere *a priori* paradox I should add that the connections indicated in the text were, every one of them, first suggested by the introspections or self-analysis of the children themselves.



snatch apples or cake; to steal from school needs greater hardihood than to steal from home; to search in a purse is more daring and deliberate than to take what lies to hand on the mantelpiece or table; and to ransack and rob a shopkeeper's till is more heinous than any. The inquirer can thus judge whether the habit is recent or long-standing, whether the first momentary temptation has grown into a callous and a calculated aim, whether the aim has become more or less systematized into a fixed sentiment or passion, and whether the original impulsive pilferer is now, after years of practice, in the way of the confirmed professional thief.

### 5. Hunting

Hunting is an acquisitive procedure in which the organs of locomotion as well as those of prehension take an essential part.<sup>58</sup> This is most plainly seen in carnivorous creatures like the lion or wolf; with them the predatory instinct is awakened, not by the near stimulus of sight, but by the remoter stimuli of smell or sound, the bleating of the kid or the scent of the gazelle: and the animal so roused must seek its prey before it can seize it. But the impulse to hunt may arise in the complete absence of any outer stimulus: some inner state, like hunger or mere restlessness, is enough to set it into motion; and its activity may subserve many different appetites or instincts of a primary

---

<sup>58</sup> Hunting has been claimed as a distinct and independent instinct by several authorities, for example, by William James (*Principles of Psychology*, Vol. II, p. 411), and by James Drever, who considers it "strangely ignored by McDougall" (*Instinct in Man*, p. 178). Many, however, incline to treat it simply as a more or less specialized elaboration of the food-seeking impulse—the latter an impulse common to the whole animal kingdom, as distinguished from the world of plants. In the higher species, both bodily form and bodily organs have become adapted to their specific mode of pursuing their prey, and with some carnivorous beasts—for example, young cats—careful observations and experiments have shown that the subsidiary processes—roving when hungry, stalking, crouching, springing, and worrying or teasing the quarry—are incontestably innate. Apparently in man, as certainly in most flesh-eating mammals, the hunting instinct is inherited more strongly by the male than by the female; and this biological difference might serve in a measure to explain why predatory raids and thefts are commoner among boys and men than among girls and women.

and provocative nature. The beast that feels a lust for food, a yearning for a mate, or an inclination to construct a nest or lair, will go searching for the necessary objects. Indeed, when not sleeping or resting, the active life of all animals other than man, and of man himself at his more primitive stages, consists largely of such quests and expeditions, sometimes random, sometimes definite, often long-sustained.

This impulse to predatory prowling is apt to overtake the most innocent youth who finds time heavy on his hands. In a good home or well-planned boarding school, or even in a boy scouts' club, his sporting instincts would be utilized as the basis of organized games and of instructive journeys and excursions. In a back street or a city park it is difficult to set forth upon a hunt without straying into trespass or temptation. Nevertheless, simply because the young thief has gone exploring private rooms or gardens, poking into passages and desks and drawers, and has at last appropriated some property that appealed to him, it is not to be too hurriedly inferred that he planned his theft or burglary with deliberate foresight and premeditated cunning. Many acts of petty larceny are forays rather than thefts. The excitement of the chase is more than the pleasure of attainment; and the joy comes rather from the skilled, circuitous process of acquiring than from the use or the value of the booty so acquired.

Much truancy and wandering take their rise from the same instinct. In villages and in those suburban districts of the larger towns which either border on the country or lie near the heaths and parks and open spaces, particularly in alluring spots that abound with trees and bushes, or with lakes and ponds and streams, the sporting motive becomes patent: the origin of a truant jaunt to such a hunting ground is manifestly no mere migratory impulse, no aimless longing for a change of scene, but a half-formulated purpose to track down some primitive prey—to course rabbits, rifle birds' nests, fish for minnows, or gather flowers and fruit. It may be added that, at a later age, much sexual misbehavior springs from the same primeval spirit of pursuit; the youth dogging the steps of some stray attractive girl, the girl promenading after any strange and

likely youth—each may be so impelled, not from any sexual hunger, but simply because the city streets provide no other animal to stalk.

Man is the hunter; woman is his game:  
The sleek and shining creatures of the chase,  
He hunts them for the beauty of their skins.<sup>59</sup>

## 6. Wandering

Next to theft, truancy is the commonest of all juvenile offenses. As stealing is the typical offense of the older time-hardened delinquent, so wandering away, whether from home or from school, is the typical offense of the younger. Among cases brought to me on other grounds, 24 per cent of the boys and 9 per cent of the girls proved to have been truants in the past; and, in nearly every one, truancy was the earliest offense.

As a rule, truancy is little thought of. But, in actual fact, it is usually the first step on the downward stair to crime—the first premonitory portent of far more desperate misdemeanors. The succeeding stages are self-evident. If a boy plays truant, he has from the outset to cover up his movements by prolonged and hardy lying. Having shirked one lesson with impunity, he will think it no more hazardous to shirk a second. The next fine day, having skulked off by himself for a whole afternoon, he will deem it wiser to lie low until nightfall, when his parents are tired and perhaps in bed. In this way meals are missed; hunger increases; and it becomes necessary to pilfer to allay the pangs.

Truancy, in the technical sense of mere non-attendance at school, has during recent years greatly diminished.<sup>60</sup> But running away from school and home together is still prev-

<sup>59</sup> Tennyson, *The Princess*, V, 147-9.

<sup>60</sup> In London, in the course of ten years, the number of summonses issued for non-attendance at school declined from 28,836 in 1900 to 7,320 in 1910; the figure has since risen a little, to 9,384 in 1920. The proportion of convictions to summonses has also declined from almost exactly 90 per cent in 1900 to almost exactly 70 per cent in 1920. The mode of disposal has changed no less. In 1900, 645 children were committed to Truant Schools, 155 to Day Industrial Schools, and 65 to

alent enough; and the youthful wanderer, like the respectable tourist at a foreign resort, falls easily before temptations he would recoil from among his own friends or within his own house.

In some cases, as we have just seen, the truant expedition is at bottom a hunting expedition. But in others the motive is quite different. Nothing is pursued, nothing is stolen, nothing is picked up or brought back. A blind impulse to roam and travel, a hunger for new scenes and new experiences, in itself so urgent, so spontaneous, so unreasoning, as to call to mind the strange migratory habits of certain animals and birds and the trekking of primitive tribes—this may be all that animates the solitary wanderer.<sup>61</sup> Just as in these lowlier parallels, the promptings are largely periodic—a product of the weather and the seasons. Indeed, runaways, as we have seen, indulge their propensities more during the months of spring and early summer than in all the rest of the year put together.<sup>62</sup>

Residential Industrial Schools. In 1920, none were sent to Truant Schools, only 13 to Day Industrial Schools, but as many as 138 to Industrial Schools of the ordinary type.

<sup>61</sup> How far I am justified in assuming the existence of an original nomadic instinct I cannot here discuss. Stanley Hall recognizes it as such (*Psychology of Adolescence*, I, p. 348, II, p. 376); but most writers pass it by. Davenport (*The Feebly-Inhibited*, Washington, 1915) concludes, from an analysis of pedigrees, that wandering is a fundamental human instinct, inherited, like so-called Mendelian traits, upon partly sex-limited lines. Among earlier studies, those most suggestive to the student of the delinquent child are two papers by an American investigator, T. W. Kline, one upon "Truancy as related to the Migratory Instinct" (*Ped. Sem.*, V (1898), iii, pp. 381-420), and the other upon "The Migratory Impulse *versus* the Love of Home" (*Am. Journ. Psychol.*, X (1898), i, pp. 1-81). Of more recent studies, the volume by E. Abbott and S. P. Breckinridge on *Truancy and Non-Attendance in the Chicago Schools* (University of Chicago Press, 1917, pp. 472. \$2.00) is perhaps the most important. An analysis of causes is attempted in the following pamphlets: J. S. Hiatt, *The Truant Problem and the Parental School* (U. S. Bureau of Education Bulletin, No. 29); E. J. Lickley, *Causes of Truancy among Boys* (Sociological Monographs, No. 3, University of S. California Press, 1917); E. A. Irwin, *Truancy: A Study of Mental, Physical, and Social Factors in the Problem of Non-Attendance at School*.

<sup>62</sup> See page 161, on the seasonal fluctuations in juvenile crime.

With these periodic vagrants, some of the simplest but most persistent examples are those of children whose parents are themselves of a roving disposition—gipsies, vagabonds, or emigrants—the progeny of an itinerant stock and perhaps of a race of nomads; for, like anger, sex, and acquisitiveness, the migratory instinct seems inherited with peculiar strength in certain families and peoples. In not a few of my truant cases—in 3.3 per cent among the boys, and in 1.4 per cent among the girls—the sheer strength of this innate tendency to wander seemed to operate as the sole or principal stimulus. And of fifty-three habitual truants whose family histories I have obtained, I find that 17.6 per cent have relatives showing marked migratory tendencies; <sup>63</sup> among more than two hundred non-truant delinquents, scarcely one.

In almost every healthy child, no matter of what race or family, the first faint promptings of this impulse can be traced. So soon as the infant has perfected the upright mode of progress he starts off with a chuckle, tempted by an open door or by a disappearing animal or cart (much as a newly hatched chick will follow almost any receding object), and toddles gleefully off, going just for the sake of going. To lock him indoors or to tether him to a seat is to aggravate rather than to remove this locomotor restlessness. It is like caging up a swallow at the season of its autumn flight.

But truancy, like other offenses, may arise from many different causes, and the contributory factors at work are much the same here as elsewhere. Bad companions, poor home discipline, the attraction of the streets, the desire to earn money, a distaste for a particular lesson, or a dislike for a particular teacher—all may play their part. Sometimes the first escape springs from no deep-seated motive, but purely from the temptation of an instant: the child is late for school and dreads

---

<sup>63</sup> See, for a concrete example, the pedigree given above (Figure 2, page 46). J. H. Williams, in a study of twenty-four American truants, found a proportion nearly twice as high. He considers "hereditary nomadism to be probably the chief contributory cause in at least 30 per cent of cases where truancy is the principal offense" ("Hereditary Nomadism and Delinquency," *Journ. Delinq.* (1916), v, pp. 273-86).



a punishment; or he meets an older companion at the playground gate and the two dive off together. The situation perhaps recurs; and soon what was at first an impulsive plunge grows into a settled custom. Thanks to the more varied curriculum and to the less repressive methods of today, hatred of school as such is becoming more and more rare: the few instances of it occur chiefly among the dull, the backward, or the sickly; and once their weaknesses have been discerned and due allowance made, or a transfer perhaps effected to a class or school more suitable, the trouble comes to an end.

As with previous offenses, so with truancy, it is essential to discriminate between the simple and straightforward cases where the impulse rises directly from some normal, healthy instinct, and those that are deeper and more involved, where the animating cause is a reaction from some secret, long-standing, and profound uneasiness of mind. Once again, it is usually among tiny children and defectives that a simple instinct seems the sole or primary motive. With the children whose age and mentality are those of the senior school, the inducements are more varied. Rambling in the open is, for the older child, still a far more natural state than sitting fixed on a form indoors. But, since the child is sturdier, he now goes farther afield. If, as not infrequently occurs, no resolute attempt is made to counteract the boy's truancy during the first year or two of his life in the upper department, habit and the constant joy of roving soon turn him into a confirmed young runaway. Slight as the offense may appear, it has become even at that early age all but incurable. Numerous examples of this type—merry, winsome, vivacious little scamps, who have found the excitement of the streets a welcome refuge from the monotony of dry lessons and a dreary home—have come before my notice; they are no more than nine or ten years of age, but already it is too late to remedy their ways.<sup>64</sup> In some, the incentive may

---

<sup>64</sup> As we have already seen, it is in the good-natured indulgence of strangers—an indulgence which the attractiveness of the tiny truant so easily wins for him—that more than half the danger lies: compare the case described above (Johnny E., Chapter IV).

I may add that, at this age, in London, a common form of apparently

be fear rather than a love of change; and what seems mere wandering may in fact be an abortive flight.

With the wayfarer of older years, the influences at work are yet more mixed and complicated; but sheer restless roving becomes, towards adolescence, even stronger than before. At puberty the old home feels narrow and confined. The remote seashore, the distant town, the place beyond the horizon, assume all the gilded charm of a far-away land of promise. In one after another of my adolescent vagrants, though the circumstances and purposes at first sight differ so much, the ultimate incentive is consistently the same. Mary, a lonely child from a Quaker's home, has run away to find a fuller and a freer social life. Michael, a wistful boy from an overcrowded tenement, roams off in search of solitude—leisure to muse and meditate away from a noisy family of eight. Bill, a typical young Londoner from Bethnal Green, has climbed into a freight train, hoping to be carried to the country or the coast. Emily, a country lass from a provincial town, has come to see a metropolis rumored to be paved with gold. Ada, from a more respectable suburb, has started rushing off, evening after evening, to the glittering West End. Harold, a public school boy, wants to go abroad and longs, a little incompatibly, for Paris or the plains of Manitoba. "They are not colonists, but pilgrims, drawn by a magnetic influence, by some divine unrest—the same that spread wings with Icarus and sent Columbus across the desolate Atlantic."<sup>65</sup>

### *Amnesic Fugues*

Impulses to wander are frequent in persons who show other kinds of periodic perturbations—hysteria, epilepsy, migraine, and recurrent depression. But in such cases it would appear that the nomadic tendency is released, rather than produced, by the disordered mental state. Some writers have made much

---

purposeless wandering is the perpetual traveling for long distances on trams or buses or trains. Here we may see how readily a prehistoric instinct attaches itself to the apparatus of the modern civilized world—riding being substituted for walking, while the total process remains just as unreasoning and automatic as before.

<sup>65</sup> R. L. Stevenson, *Will o' the Mill*.

of the rare pathological cases known as amnesic fugues.<sup>66</sup> Here the wanderer seems to make his journey in a state of half-unconscious automatism. The impulse drops suddenly upon him, like a seizure or a fit; and, when all is over, no memory seems to survive of where he has been or of what he has done. Hence, cases of wandering form yet another group where a diagnosis of "psychic epilepsy" is repeatedly feared or suggested. Certainly, it cannot be denied that perambulations of this kind, seemingly motiveless and presumably forgotten, occur from time to time, both among children and adults, as episodes in mental conditions that are truly pathological—not in epilepsy alone, but also, though perhaps more rarely, in senile dementia and in dementia præcox.

There are, however, all degrees of automatism and of amnesia. It is exceedingly common for the young excursionist, on his return, to appear "quite unable" (as parents and teachers so constantly report) "to give any account of himself." But, in most instances, the child simply does not care to acknowledge what precisely he has been about. Often he has tramped away simply to avoid all personal contact with the very parent or teacher now cross-questioning him; and his silence is but another method of withdrawal: as formerly he fled from home or school, so now he flees into himself. Occasionally, in his expeditionary encounters, he may have been led into something he is too frightened to confess—a theft to satisfy his hunger, the spending of money already stolen, a visit to a forbidden restaurant or cinema, or even some sexual or homosexual misadventure. More frequently, he has been to no place that he can name and has done nothing that he can narrate: he has mooned along in a daydream; his way has led him through the city of fancy, and his real itinerary is marked upon no purchasable map. But how can he put all this to a prosaic and practical elder?

In one of my cases alone was there any well-authenticated

---

<sup>66</sup> The fullest study is that of Joffroy and Dupouy, *Fugues et Vagabondage* (1909). Later references will be found in Marie and Meunier, "Le Vagabondage Constitutionnel," *Annales Médico-psychologiques*, 1911 and 1912.

history of epileptic seizures in the absent-minded traveler himself, and in no more than two was there a history of epilepsy in the family. Usually where the amnesia is genuine and certainly where it is at all severe, there, in my experience, the child proves to be neurotic, suffering in most instances from a mild hysteria. Hypnosis or, better still, a simple analytic technique, with patience, sympathy, and a deft and delicate approach, will generally revive the faded memory—much as a forgotten dream can be recovered when lost among the vivid sensations of the waking day.<sup>67</sup>

None of my cases of truancy could be more instructive than the following, in which instinctive and neurotic tendencies seemed to be combined. Stanley<sup>68</sup> was a well-dressed, healthy

<sup>67</sup> For an illustrative instance, see the case of Flora S. described below (Chapter XIII).

<sup>68</sup> Stanley Q. *Age*: 12½. *Home Circumstances*: Father, a pale, grave, somewhat ponderous official, aged 56; a higher grade Government clerk; no rent, the house being his own; has small private means in addition to his salary, giving him a total income of £900 a year. A great reader, a devoted civil servant, with philately as his absorbing hobby, he comes home tired from his office every evening and considers his domestic affairs ought to manage themselves. Mother, aged 53, quiet, reserved, and aloof in manner; intelligent in a narrow way; and not so much motherly as old-maidish. She and her husband are devoted to each other but make poor companions for the children. The children, however, are liberally provided with books, pocket money, playrooms, and toys. There are two others besides Stanley, a dull and somewhat childish girl of 14 and a bright boy of 10. These two the father constantly holds up as models of what children should be. The fact is, however, that by temperament they fit neatly into the quiet, stay-at-home life of the elderly parents; the eldest and the youngest pair well together, and in their company Stanley makes an unwanted and incongruous third. Of themselves, these conditions form no reason for delinquency; it is Stanley's peculiar disposition that makes him, in a home where most children could easily adapt themselves, nothing but a misfit.

*Family History*: See above.

*Physical History and Condition*: Walked at 14 months; talked at 15 months. Troublesome during teething ("used to cry, or go pale"; never fainted; no convulsions). Measles, chickenpox. Present health apparently normal: no significant neurological signs. Headaches, doubtless genuine, reported at school; none ever noticed at home. Height, 36.2 cm.; weight, 33.3 kg. Broad-shouldered, but slouches a little; hangs or averts his head, and seems unable to meet his interviewer's eye.

*Intelligence and School Attainments*: Mental age: (Binet tests), 13.5; (Performance tests), 13.0; (average mental ratio, 110). Reading, 8.0.

boy of twelve, with an absent look and a low, slow, inarticulate mode of speech. For more than three years he had been playing truant on Wimbledon Common, sleeping at night upon area-steps, pilfering buns and bananas from shops and stalls, and pawning his father's books and Sunday clothes to pay for a seat at the cinema. He had now been charged with the theft of a five-pound note, extracted from his uncle's cash box. His sole explanation was a shrug and a mumble: "I want to go away. I took it to get abroad."

His father and his father's relatives were of a neurasthenic stock; one had died in an asylum, and two had suffered from severe nervous collapse. His mother's uncles and brothers had emigrated to the colonies; and several had accumulated considerable wealth. Thus, on one side, there was a roving and acquisitive tendency which ran like a thread through the young vagrant's ancestry; and, on the other, there was the taint of an unbalanced mind. Stanley was a blend of both.

Unlike the usual vagabond and pilferer, he lived in a clean and comfortable villa in the suburbs. It looked a home that most little Londoners would envy, not run away from. His ramblings and his exploits seemed unusually pointless; his thefts he barely troubled to conceal; and, as to where he had been, he could offer no word of explanation. His teachers, accordingly, deemed and pronounced him mentally deficient; and the family physician spoke of epilepsy.

His health was perfect. There was no real evidence for either *grand* or *petit mal*. But he was backward. Some smattering of Latin nouns he had, and a little French conversation.

Spelling, 7.5. Composition, 8.0. Arithmetic, 7.8. Handwriting, 8.5. Drawing, 10.0. Handwork, 11.0. Geography, 10.5. History, 10.0. Motor capacity and mechanical ability, good. Visual imagery, good. Memory, poor. Observation, imagination, and report, about average. Meager powers of verbal expression.

*Temperament:* Not markedly unstable, but somewhat sensitive, taciturn, and repressed. Mother reports masturbation when he was six, and states that, almost as soon as he could walk, he became "keen on wandering and exploring." A daydreamer; and, like most solitary wanderers, of an "introverted type." Signs of secret antagonism against father. At school he makes few friends and the others joke about him as an oddity.



But in reading, writing, spelling, and arithmetic, his attainments were barely those of a child of eight. It was no marvel that his master had thought him defective. But when his inborn abilities were tested, the result was startling. So far from being mentally deficient, his native intelligence was well above the average for his years. He had the high mental level of a child of thirteen.

In spite of innumerable tests and interviews, it proved extremely difficult to penetrate the boy's own thoughts. It became necessary, therefore, as so often happens, to see something of the child's spontaneous behavior in more natural surroundings. He was invited to a tea party with other playmates. Sullen, silent, and constrained, he sat apart from the other little visitors and seemed wholly unacquainted with common boyish games. Later he was taken to the Zoo. The most taciturn child usually breaks into chatter as he watches the monkeys, the elephants, and the snakes. Stanley's sole illuminating remark was one of disapproval. "Why don't they keep the orang in a palm house, like there is at Kew? You couldn't imagine you were in Borneo in a place like this."

But, of all places where the childish mind unbosoms itself, there is none like the pantomime or cinema. Stanley was taken to a picture palace by a kind assistant. Here once more the workings of his mind were singular. Charlie Chaplin he watched without a smile. But he gossiped volubly about the scenes from foreign lands. His favorite picture was a serial that he had evidently been following from week to week. The hero was a young, intrepid traveler, who, defrauded by a grasping stepfather of all the family estates, had gone forth to try his fortune among pirates, cannibals, and South Sea islanders. Stanley lived through every episode, as though exploit after exploit was his own. At last his secret was emerging. All his interest and imagination were absorbed in a life of adventurous make-believe. Hour by hour, instead of drudging at mechanical sums, or learning the dull language of dead Romans, he was reveling in a glorious, never-ending daydream. He was in fancy a hero and a traveler. Like his namesake, his favorite idol in history, he yearned to be a great explorer; and in his

own limited way he had toured the rougher streets of London, the parks, the commons, and the docks, conjuring up extravagant feats against his visionary foes.

To flavor with some tang of truth these whimsical romances, there had to be real danger and real deeds of daring—feats in which the policeman, the shopkeeper, and his unsuspecting relatives played the imaginary part of hostile savages or usurping rivals. They were unjust barbarians, to be outflanked by every possible maneuver, and their restrictions were arbitrary barriers, made only to be broken through. Thus the boy was in the same predicament as the orang-outang at the Zoo—banging his head against the bars of a civilized cage while his heart and thoughts were in the wild islands of the Pacific.

He was sent to be coached by a country clergyman whose home was more like a farm than a vicarage. In less than three years he made nearly five years' educational progress, and has now settled down, without any relapse, to be trained as a naval cadet.

## 7. Curiosity

From Descartes down to McDougall, in their catalogue of inborn human motives, nearly all psychologists have found a place for the instinct of curiosity. The associated emotion is generally designated wonder. Unlike most of the impulses we have hitherto considered, curiosity has no obvious innate motor tendency, no characteristic movements of its own. For this reason it may be passed by more briefly. The delinquent, particularly the more intelligent specimen of the roving truant class, is often an inquisitive young sightseer, prying into life, experimenting with existence, eager to spy out the wide world and its ways. It is not riches that he seeks nor pleasure that he loves, though he may think so; his aim and his sufficient reward is to sample the full variety of human fate. With him—perhaps with all of us—wondering and wandering are closely akin.<sup>69</sup>

---

<sup>69</sup> Owing, however, to the high mental level of the most typical of the inquisitive group, I should be disposed to consider their propensity as in part an intellectual outgrowth rooted in the hunting instinct rather

That much of the apparent naughtiness and cruelty of the small child is at bottom no more than the impulse of a Peeping Tom is plain to every one. The boy who breaks open his sister's doll, vivisects his pet mice, or pulls the kitchen clock to pieces, is actuated rather by an itch to see and know than by a taste for hurting or destroying. At a later age, it is from much the same motive that his first cigarette is smoked and his first glass of beer gulped down with a dissembled grimace; and in at least two cases I have met with (girls whom I regard as under-sexed rather than over-sexed and that too, not on the ground of repression but of physiological constitution) a grave sex delinquency appeared to have originated in pure unimpassioned curiosity.

### 8. The Herd Instinct

Man belongs by nature with the sheep, the deer, the chimpanzee—animals that roam in flocks or forage in herds—rather than with the solitary animals, like the lion or tiger, that set out on their depredations alone. He is born with a gregarious instinct; he is, as Aristotle defined him, essentially a social creature. The term does not imply that he lives in communities for motives resolutely rational—for better self-defense or for economic gain; nor that his natural inclination is to think first of the good of his tribe. It means simply this: that, by virtue of his hereditary constitution, he is compelled, quite blindly to begin with, to seek out and to remain with others of his group. For the deep thrill of crowd excitement, the emotional surge that we all experience when massed together in a throng, we have no very apposite word; but to the acute uneasiness that every one feels so long as his sociability is left ungratified, we give the name of loneliness. Its extreme unpleasantness is well illustrated by the fact that solitary confine-

---

than in the migratory; but all three impulses—wandering, hunting, and simple curiosity—seem in many of the higher animals sufficiently obvious and distinct. Some psychologists, it should be added, would resolve curiosity into the simple, semi-reflex, exploratory movements of the sense organs, as of the eye in looking and the ear in listening, aided, in such creatures as man and the monkeys, by the manipulative movements of finger and thumb.

ment is denounced on all hands as a torture too cruel and too inhuman for a civilized society to inflict.

The unreasoning character of the impulse explains a curious paradox: that the social instinct may be the origin of many antisocial actions. Young criminals, like young wolves, hunt usually in packs, and it is a primitive advantage of the pack or the gang, not merely that numbers confer strength, but that the sympathetic interplay of instinct between this member and that, starts, quickens, and intensifies springs of behavior otherwise inert. Everywhere in the human world, the ethical code of a crowd lies far beneath that of its component individuals: its morals are not the sum of the morals of each unit, nor yet their average, but their lowest common denominator, the outcome of the motives shared by all; and these motives, in turn, will be the crude and universal instincts. The leader, if there be a leader, will be the one who most readily responds with, and most powerfully works upon, the various fundamental emotions—the most excitable member and the most aggressive, not the most intelligent or the most enlightened.

Though the gregarious impulse is hereditary, its emergence, like that of the sex instinct, is in man somewhat delayed. Children of infants' schools—little boys and girls below the age of seven—tend, in their spontaneous romping, to play alone; from the age of seven to that of ten the favorite games—fick, hide-and-seek, and blind-man's-bluff—still preserve a strong tincture of early individualism, and the majority of juvenile delinquencies are, at this epoch, carried out in solitude. By the age of ten or eleven, competition, rivalry, and the element of skill come more and more to predominate; and the mischievous adventures of these bigger boys—their thefts, their truancies, and their incidental escapades—are now often conducted by couples. Well before the dawn of puberty, however, and towards the age of twelve or thirteen, they combine and cling together in larger social units, more or less loosely organized; their methods, their initiatory rites, and their collective activities now resemble those of a precivilized stage of human evolution: they play pirates and robbers or cowboys and Red Indians, and form bands for hunting, fishing, fighting, and

marauding. At the school-leaving age their enterprises grow more serious, and the fondness for predatory gangs reaches its height, with the average London boy, about the age of fifteen.<sup>70</sup>

In the group of 123 boy delinquents analyzed for statistical comparison, as many as fourteen, that is, 11.4 per cent, belonged to a juvenile gang of three or more members.<sup>71</sup> In the parallel group of 74 girls, not one.<sup>72</sup> Thus, with the girls almost every offense was committed while alone; with the boys no more than four out of every five—the balance of 9 per cent being made up of pairs working together.

---

<sup>70</sup> Among the lower and less intellectual types of the poorest slums, the culmination is perhaps a year or two later. In America it apparently occurs at a somewhat earlier stage. See the interesting studies and statistics of Sheldon, "Institutional Activities of American Children," *Am. Journ. Psychol.*, IX (1898), pp. 425-48.

On the general subject of the social instinct in children some suggestive conclusions and references are to be found in Miss Reaney's monograph on "The Psychology of the Organized Group Game" (*Brit. Journ. Psych., Mon. Suppl.*, IV, 1916).

<sup>71</sup> In the inquiry by the Juvenile Organizations Committee as many as 63 per cent of the boys are said to have been "working in gangs." But it is clear, from the published table, that over one-third of these—23 per cent of the total—were working in couples only, and were, therefore, mere comrades and not members of a gang in the accepted sense. A few of the bands encountered, however, comprised a membership of from ten to sixteen (*Board of Education Report on Juvenile Delinquency*, p. 18).

In the Scottish inquiry, out of 89 boys, 12 were working alone, and 56, that is, 63 per cent, were working together in batches. It should be added that the offenses were in every case serious: boys breaking by-laws by playing street football were not included (*Report of Scottish National Council of Juvenile Organizations*, p. 16).

<sup>72</sup> With girls the social instinct, though equally intense, seldom develops into a conscious group sentiment. Their sentiments are more for single individuals. Quite frequently a brace of girl chums may be met with who have run away from home together, and female sex delinquents often live together, and go out together, in pairs. Outside the limits of the series that I have kept apart for statistical comparison, I have, indeed, more than once, come across a little knot of older girl delinquents, but their union is far more loosely knit and far more casual than those of the boys. Often, the sole bond lies in the tendency to congregate in the same café for gossip. In the East End of London, however, there is at present a self-organized club of ex-delinquent girls, with wholesome law-abiding aims, who call themselves the "King's Own"; it is a condition of membership that each, at one time or another, must have "enjoyed His Majesty's hospitality."



Of these delinquent gangs the members have been in nearly every instance between twelve and sixteen years of age. The names of the more self-conscious troops, often borrowed from the penny novelette or the film melodrama, are sufficiently suggestive of their spirit—the Cop Dodgers, the Hell Hounds, the Black Hand League, the Belt and Pistol Club. Usually these self-bestowed titles are more formidable in sound than in reality. But sometimes the group has been formed, or professes to have been formed, for some high-flown, anarchical object; and, like the band of Captain Macheath in Newgate Tavern, the members will echo some specious catchword: "We are all for a Just Partition of the World, since every man hath a Right to Enjoy Life."<sup>73</sup> In general, however, the aim is one of adventure rather than of principle; their organization is of the most lax and accidental nature; and the most dangerous mobs of all are simply called after the streets they inhabit or frequent.

The offenses perpetrated by the gang I have encountered are chiefly of the following kind (I give them in order of frequency and ignore paltry breaches of police regulations—like playing forbidden games in public thoroughfares—infringements which, of course, would be the commonest of all): mischievous damage, petty theft, truancy, fighting, gambling, burglary, endangering passengers on the railways, and homosexual practices—the last often as an item in the ceremony of initiation. Of these exploits, all but a few were carried out, not for gain or malice, but chiefly for the joy of a concerted venture, or for the glee of recounting, when all is over, the glory achieved either separately or in small sets.

Not every little horde of youngsters is to be regarded as a crew of hooligans or roughs. Most working boys, indeed, belong to what they call their "click." But very few "clicks" develop into criminal gangs; indeed, the atmosphere of the "click" is far less secretive and exclusive than the etymology of "clique" might seem to convey. Their evening or holiday routine is to meet their "mates" or "pals" under a railway

---

<sup>73</sup> Gay, *The Beggar's Opera*, II, i, 27.

arch or by a coffee stall; to lounge about, puffing cheap cigarettes and debating county cricket or league football, and then to stroll off in the direction of a park or ginger-beer shop; sing a little, perhaps to the accompaniment of a mouth-organ, and then saunter home. To become the terror of their district is seldom part of their aim. Less than twenty years ago, an American psychologist could write: "In London, where these groups are better organized and yet more numerous, war is often waged between them, weapons are used, and murder is not so infrequent"<sup>74</sup> and, conceivably, of nineteenth-century London this may indeed have been true. But during the last two or three decades most of this collective energy has been diverted by the rapid growth of boys' clubs into harmless and even edifying channels.

Towards the close of adolescence the gregarious tendency declines or becomes less definite. The social instinct, if not exploited and absorbed already by the efforts of athletic societies and by the requirements of industrial life, gets merged very largely in the instinct of sex. Having hailed a similar "click" of girls from a neighboring street, the company dissolves into couples or quartets, to indulge in a little mutual horseplay or philandering, and a year or two later it ceases to exist. Boy goes with girl rather than with other boys.

## 9. Self-Assertion

Among social animals such as man two further instincts of high importance have been evolved—self-assertion and self-submission, and corresponding to them two emotions, which we may loosely term, with older writers, pride and humility, respectively.<sup>75</sup> Self-assertion or self-display is regarded by most

---

<sup>74</sup> Stanley Hall, *Adolescence*, Vol. I, p. 362. Compare also Charles Booth's description of the youthful bands that once terrorized the streets of Hoxton—a part still notorious for its juvenile gangs (*Life and Labour in London*, Third Series, Vol. II (1902), pp. 114-15).

<sup>75</sup> Strictly speaking, pride and humility imply self-consciousness, and designate complex sentiments rather than simple emotions. But technical circumlocutions such as "positive and negative self-feeling," however exact, would be scarcely intelligible, and altogether out of place, in a brief and popular exposition.

recent psychologists as a definite instinct, analogous to, but distinct from, anger, acquisitiveness, curiosity, and the rest. Darwin has shown how it is inherited by man and by many lower animals—some of the latter, as the peacock and turkey, being adorned by nature with a special apparatus for self-glorification.

In most delinquents this self-assertive instinct is vigorously developed. In many it helps strongly to reinforce whatever aggressive or adventurous tendencies their composition may contain. In some, perhaps, it constitutes the sole source and stimulus of their mutinous or mischievous enterprises. In the ringleader it is an essential and invariable quality—a powerful incentive for both good and ill. Among boys self-display incites to feats of rivalry, daring, and defiance, and to all that is contemptuously derided by their fellows as “swanking” and “showing off.” Among girls it may lead, almost from the earliest years, to vain and romantic lying and to affectations still more hollow and theatrical for courting self-attention and for keeping always in the lit circle of the limelight; at a later age, it may drag them through theft and immorality for the sake of gay clothes, gaudy jewelry, and all the garish adjuncts to feminine conceit and ostentation.

But in both sexes, and in a broader way, much juvenile misconduct is simply a forcible mode of self-expression. Adrift in an impressionable world, increasingly aware of his own personal power and of an ever-widening influence, the growing child inevitably seeks, in the most incisive and audacious manner open to him, to emphasize his own individuality and to affirm his own independence. Many young persons, not naturally self-willed, pass through a stage of stubborn perversity; and, to an almost intolerable degree, become (in the psychologist's phrase) “contra-suggestible.” The barest hint of one course of action is sufficient to make them dash to the very opposite. In these, and similar cases of apparent self-assertiveness, a superficial obstinacy often covers and in some ways counterbalances a deep and lurking sense of real inferiority. This form of self-compensation is, indeed, one of the commonest and least suspected mechanisms within the delin-

quent mind. What the child lacks in genuine courage and true strength of character, he tries to make up for by wild spasms of wayward disobedience and arrogant aggression. And, "in his heart, lie there what hidden woman's fear there will," he will have—

A swashing and a martial outside,  
As many other mannish cowards have  
That do outface it with their semblances.<sup>76</sup>

### Cruelty

Cruelty forms a matter for numerous accusations against school children and deserves a separate discussion. The accused is more generally a boy than a girl, and, strange to say, quite often a tiny child of tender years. The actions reported are most diversified, and the motives equally mixed. Sticking pins into the eyes of puppies, singeing the cat's whiskers with a match, snipping wasps in two with scissors, putting hot hairpins on the baby's arm, and, in short, plaguing animals and smaller children by countless out-of-the-way devices are among the chosen pastimes of many youthful tormentors.

The instinct underlying such childish atrocities seems primarily to be the one we have just examined—the instinct of self-assertion. Curiosity, and in other cases some kind of sporting or hunting impulse, may on occasion play a leading part. At times, too, as we have already seen, a cruel injury may be done under the spur of combativeness or anger. Indeed, by some psychologists the wish to produce pain has been raised into the very definition of anger. "Anger," says Bain, in a celebrated passage, "contains as its essential peculiarity an impulse knowingly to inflict suffering on another sentient being and to derive a positive gratification therefrom."<sup>77</sup> As Shand, however, has pointed out, anger in such a form could not be purely instinctive; a passion so self-conscious must manifestly be acquired.<sup>78</sup> Defined in Bain's terms, it would admittedly

<sup>76</sup> *As You Like It*, I, iii, 121-5.

<sup>77</sup> *The Emotions and the Will*, Chap. ix, p. 4. Seneca seems to have been the first philosopher to argue that "this evil takes its rise from anger" (*De Ira*, II, v; cf. III, xvii and xix).

<sup>78</sup> See Shand, *loc. cit.*, p. 243.

depend upon a power to recognize pain in the victim and upon a capacity to anticipate his pain as the natural result of the vicious action.<sup>79</sup> But to pursue pain thought of as such, and to aim at it as an end in itself, would obviously require a degree of intelligence comparatively advanced; whereas an instinct, in so far as it is an instinct, is utterly uncomprehending and blind.

Now a tiny child can no more frame a conscious notion of the pain he is inflicting than could a boa constrictor or a bear. The perception that the act is inherently cruel is confined to the older and more intelligent onlooker. To the human eye, the kitten playing with a captured mouse seems animated by ruthless cruelty, but the kitten itself can neither recognize nor relish the throes of its tortured captive. It is getting pleasure out of the normal exercise of a natural kittenish instinct, and nothing more. What it enjoys is its own activity, not the suffering of the other creature; a jiggling spool would serve as well. So with the infant persecutor who loves to pull the puppy's tail or pluck the wings from butterflies and moths. What looks like heartless spite is no more than a form of playful hunting or aggression, or the practicing of a new-found domination over other animals or other children. Of what he is really about he himself has no clear notion. At most he reaps some dim gratification from the violent and extraordinary effects which his behavior is able to evoke. It is, therefore, of the utmost importance, in dealing with the seeming brutality of the smaller child, to avoid reading into his mental processes an insight that exists solely in our own. What is cruel is his act, not his intention.

Nevertheless, in certain persons, and at certain levels of intellectual life, a gruesome tendency may undoubtedly emerge to find joy in the anguish of another. How deliberate the

---

<sup>79</sup> The power of discernment rests, no doubt, upon a further factor—on what is known as "primitive sympathy." The expression of pain in others instinctively excites pain in ourselves, and this principle in turn may operate in two ways, a negative and a positive. A callous child, without this gift of automatic sympathy, fails to appreciate that he is actually producing pain. Another, more sensitive, realizes, through this same form of sympathy, that he is hurting, and revels in the fact that the agony is not his own.



impulse may become is shown by the invention of implements and of methods of torture, both in past ages and among school-boys at the present day—implements and methods all cunningly designed to cause not injury, but pain. The bully, to denote his grim contrivances, has compiled a whole vocabulary of technical terms: "corkscrews, ag-ag, rockin', head-knucklin', arm twistin', brush drill (which requires no brush), and the key (which has no key at all but hurts excessively)"—such was Stalky's comprehensive list.<sup>80</sup> And moral persecution has varieties yet more numerous, and infinitely more refined, than physical. Indeed, so exquisite and so intoxicating is the pleasurable excitement aroused in the tormentor by the practice of his passion that many have considered him to be gratifying some perverse and private sexual lust.<sup>81</sup> But, with children who have not yet ripened into sexual maturity, the chief emotion is undoubtedly self-assertion—a craving to feel or express power. To hurt another in playful anger, with the sure or even doubtful expectation that he will not or dare not get angry and hurt the torturer himself, is a pastime that imparts a triumphant throb of exaltation, a sense of self-importance, which the inferior and less potent natures are the quickest to enjoy. And, significantly enough, the bully, the tyrant, or the tease, apart from the moments when he is gloating over his prey, is often a cowardly, weakly, or even good-natured fellow. The seeming inconsistency between these two phases of his character is, as we have observed already and shall see again in a later chapter, a paradox to be resolved by the simple fact that the one phase is compensating for the other: in the wanton exercise of power the sense of impotence is stifled.

---

<sup>80</sup> Kipling, *Stalky and Co.*, "The Moral Reformers," p. 136.

<sup>81</sup> Freud and the Freudians treat sadism as a definite and instinctive variety of the sex-impulse. The facts have been thoroughly studied, among other investigators, by Havelock Ellis. Most of the well-known instances, however, Jack the Ripper in this country, Vacher and Riedel on the Continent, and probably the Marquis de Sade himself, seem to have been definitely pathological cases; and, at any rate among young persons, it is in the rarer cases of a psychopathic trend that the two impulses seem most usually conjoined.

## CHAPTER X

### TEMPERAMENTAL CONDITIONS: INSTINCTS AND EMOTIONS—*Continued*

*C'est se tromper que de croire qu'il n'y ait que des violentes passions, comme l'ambition et l'amour, qui puissent triompher des autres.*

It is a mistake to suppose that there are none but violent passions, like ambition or love, or that these alone can triumph over the rest.

LA ROCHEFOUCAULD.<sup>1</sup>

HITHERTO we have discussed the more active and provocative instincts. It remains to glance, with less detail and minuteness, at those which seem deterrent, impulses which might be thought to affect criminality more by their deficiency than by their excess.

### SPECIFIC INSTINCTS—*Continued*

#### 10. Self-Submission

As an instinct, self-submission is no less characteristic of the gregarious animal than self-assertion or self-display, and the corresponding feeling of humility may be as poignant as the feeling of elation or pride. Much that was once explained by the so-called faculty of imitation and much that is now ascribed to the herd instinct is in truth very largely a result of this obsequious tendency. Men are like lambs, and follow in a flock wherever the bell-wether leads.

Criminals are not generally thought of as distinctively docile. Yet an overdose of native pliancy proves in some to be their most notable trait. The youngest offenders, in particular, are repeatedly set down by those who know them as "weak-willed," "led easily by the nose," "without any backbone of their own." Often the child will state, and his statement can be confirmed, that he has never been tempted into any trespass except when

---

<sup>1</sup> *Réflexions Morales*, CCLXVI.

in bad company; then he never can resist. No matter whom he is with or what suggestion is put forward, to obey is part of his nature. Suggestibility, in this sense, is not over-common among delinquents; I have noted it in but 4.6 per cent of my list; but, where present, at any rate with boys, it is apt to be the main decisive factor. Of their failing these flaccid creatures are often acutely sensitive: "I always seem to do what they tell me," says one limp and languid little thief. "If he asked me to jump into the Serpentine, I believe I'd do it," says another, the inoffensive dupe of a veteran burglar of fifteen. "I'm all right," says a third, "if I keep away from them; but when I'm with them, I've just got to do the same."

Their suggestibility is at times almost hypnotic, and, in point of fact, many of these soft, invertebrate weaklings can be thrown quite easily into a somnambulic trance. Even without the arts of mesmerism, their habit of facile acquiescence may sometimes be detected with the simplest of tests. Binet's method is well known. The child is first shown some suitable picture; then, after its removal, he is tactfully questioned upon items or objects that were never contained in it: he is asked, for example, of a bareheaded man in a monochrome photograph—"Was the man wearing a cap or a bowler?" or "Was his necktie pink or navy blue?" The child who slips meekly into every trap (provided the young knave is not himself hoodwinking his unsuspecting catechist) proves, as a rule, almost equally gullible in the intercourse of everyday life. The converse is less certain; the child who is compliant outside is not always demonstrably credulous in the laboratory. And, alike with successive tests and under different instigators, a stolid self-assurance at one time is quite compatible with abject subservience at another.<sup>2</sup>

---

<sup>2</sup> The reader inexperienced in the uncertainties of all psychological testing should be warned that tests of suggestibility, though numerous, are not highly reliable; and, in particular, that the suggestibility test inserted into Binet's scale for measuring intelligence is worthless for gauging both intelligence and suggestibility. On the uses of tests of suggestibility generally, in work with the individual delinquent, the brief account given in Healy's volume (*op. cit.*, pp. 93-6) is exceedingly instructive.

Where treatment is at issue, it is always to be borne in mind that the child who is weakly tractable for evil may be equally amenable for good. The most effective remedy is not to try hardening his will by moral gymnastics; it is to find him the right companions and the most appropriate leader.

### 11. Fear

The manifestations of fear and anxiety are not so important in the delinquent child as in the neurotic. Here, therefore, they may be dismissed quite shortly. In its simple and most direct operation, the emotion of terror tends less to provoke than to restrain delinquent actions. And it is upon this inhibitory tendency of dread that the principle of deterrent punishment is founded.

The instinct correlated with the emotion of fear is the impulse to escape. It embraces, as McDougall has insisted, at least two separate tendencies—to flee and to conceal oneself. The former, the impulse to escape by flight, is often, as we have seen, the prime motive in conduct reported as truancy or vagrancy. The apparent wanderer is, in fact, a fugitive. What is the true source of his alarm can be found only after narrower study. He may be eloping in a panic from some desperate strait at home or at school. He may be seeking a chance to spend his stolen plunder and at the same time to avoid, or at least to postpone, the detection and penalty of his theft. Or, perhaps, detected and punished already, he may be rushing away from the new restraints imposed upon him or from the humiliating scorn which his exposure has aroused among his family and friends. Or, finally, by an irrational and almost symbolic reaction, he may be trying to flee from temptation, striving to run from himself, unaware of the ancient warning, "*patriæ quis exul se quoque fugit?*"<sup>3</sup> In any case, whatever be his deeper motives, to look upon him as a roving adventurer when at heart he is a terror-stricken runaway is to take the hare for the hound, the hunted for the hunter.

---

<sup>3</sup> "What exile from his home can flee from himself as well?" (Horace, *Odes*, II, xvi, 19-20).

Flight from custody has become more and more rare. Not unnaturally, when first despatched to an industrial school or Borstal institution, a newcomer occasionally endeavors to decamp, and the public, notified through the press, is sometimes unduly sympathetic and sometimes unduly disturbed. The decrease in cases of absconding is due largely to the removal of the main incentive—locked doors. When exits are open and windows unbarred, the glamour of the enterprise melts away.

All criminals, with few exceptions, are secretive, and the second of the twin tendencies of fear, the tendency to self-concealment, is naturally carried to the pitch of a high art by sly offenders of a timorous spirit. To succeed, the culprit must not only hide his own person during, and perhaps after, his act of crime; he must not only disguise the existence of damage unlawfully done or of possessions unlawfully abstracted; he must, above all things, dissemble any awareness of his piratical doings that might be divulged by the spoken word. Most delinquents lie. But, from obvious causes, thieves lie more regularly than those who commit violence; and those who commit violence against property more than those who commit violence against persons. Indeed, with the young offender who is credibly alleged to be frank and truthful, there is every prospect of an immediate reform, unless ill-timed punishment or injudicious reproach adds stealth to stealing, and so grafts, on an open tendency to the original misdemeanor, a secondary habit of cunning and reserve. When he begins to practice deceptions that are more than merely verbal, with elaborate stage business and sham accidents trickily arranged, then his duplicity is to be viewed with no mild or indifferent eye.

Lying, as such, is not instinctive; hence, the relation of protective lying to the primitive instinct of fear has much the same indirectness that we have noted in other offenses with the tongue, in the obscenity that springs from the sex instinct, and the insults, threats, and slanders that arise from the impulses of anger. Beyond the bare monosyllabic disclaimer, all lying, whether protective or assertive, involves, as we have seen, special intellectual elements—a ready invention and the gift of



words. Under those headings I have enlarged upon it already, and here need add no more to what I have advanced at some length above.

Many delinquents suffer not from too much, but from too little fear. They are reckless, headstrong, and venturesome. In some this unflinching fearlessness, the utter absence of all prudence and precaution, may be the direct result of an inherited shortcoming; for if the excess of an instinct may be inborn, so equally may the lack of it. Quite as often, however, the defect is a defect, not of feeling, but of understanding. The child shrinks readily enough from dangers actually present; but he is without the requisite intelligence, the power of imaginative foresight and reflective inference, to anticipate the possible risks that he may be running; he is literally foolhardy. Sometimes the delinquent's fears are moral rather than physical; he is less afraid of actual bodily hurt than of seeming afraid of it. Hence, it becomes his plucky part to stand up to his punishment or even to invite it; to bluster, defy, and show a bold and brazen front; to accept without a quaver every challenge, wager, or dare. Should he secretly feel some tremor of alarm, this only adds a further piquancy to his adventure. His is the spirit of the bushman poet:

Never a game was worth a rap  
For a rational man to play,  
Into which no danger and no mishap  
Could possibly find their way.<sup>4</sup>

## 12. Disgust

Disgust is another emotion, which, mildly indulged, brings with it a secret thrill of power, a glow of manly sturdiness. To shock ourselves is almost as exhilarating as to shock and horrify our acquaintances. There is a gusto in making mud-pies and in eating rotten cheese. Many a revolting habit, often wrongly ascribed to sex and seeming to the refined adult nothing but the stigma of the degenerate or perverse, takes its zest from a tentative trifling with this strange and pungent instinct.

---

<sup>4</sup> Adam Lindsey Gordon, *Sea-Spray* (1866), "In Utrumque Paratus," st. i.

The so-called moral sense is in part an æsthetic sense, a nice fastidious taste in matters of social behavior. And the young delinquent generally strikes the well-bred teacher as appallingly obtuse in his perceptions of the unsavory. As was said of one of them, "he has no nose for the nasty." Where this is so, the offenses have, as their negative precondition, a deficiency in the instinct of disgust, instead of an excess. Yet such a deficiency is, I think, exceptional. And the paradox I have just enunciated is based on an accepted principle of psychology. All feelings and all sensations, even things so universally unpleasant as terror, pain, and sorrow, or bitter flavors and objectionable smells, are agreeable if sufficiently light and delicate; they are not displeasing until a certain threshold of intensity is passed. Thus, disgust, in the disgusting offender, is not so much lacking in itself; it is marked rather by an unusually high transition point from pleasantness to the reverse. The rankness that would nauseate the average child is to the epicure in horrors an added relish. Disgust is present, but, like fear in the venturesome, it acts not as a deterrent but as a spice.

### 13. Affection

It is not to be supposed that all human instincts without exception are in their essence antisocial and criminalistic. What has been extolled as "the best and noblest impulse of mankind," the parental or protective impulse, springs from an in-born tendency, found among all the higher animals, including man. Even this propensity has its mechanism, its bodily apparatus. Among the lowlier species, protection may be afforded to the growing offspring by some purely physical structure, specifically adapted—like the pouch of the kangaroo or egg-sac of most birds—to this particular end. Among the highest species, where the young are born immature and develop slowly, the instinct takes on a character more purely psychical. In the human race these maternal or cherishing impulses are by no means the monopoly of the full-grown woman: they emerge in early childhood, and are exhibited by the male as well as by the female, though doubtless in a form less

intense and less abiding. The corresponding emotion—named variously love, affection, sympathy, or tenderness—has been held to be “the main, perhaps the only, source of altruistic conduct.”<sup>5</sup>

So far from being altruists, most criminals are disobliging egoists, unloving and unloved. It is, therefore, no matter for surprise to find in reports on individual cases constant comments upon the cold, pitiless, and mercenary disposition shown sometimes from the earliest years. One after another is described as “destitute of all affection,” “without love or feeling for any but himself,” “not tender, but certainly tough.” Gratitude—a compound feeling or amalgam in which (according to the psychologist) both tenderness and self-submission are alloyed—is singularly wanting in their hard, self-seeking little hearts.

Yet there are assuredly exceptions. In many an unstable child whose every emotion is strongly developed, affectionate tendencies are often remarked, standing out with incongruous contrast against the selfish instincts which he equally displays. A few, particularly among the younger girls, are generous, and more than one of my thievish acquaintances steal solely to give presents to their favorite teachers or their bosom friends. Thus, a misguided impulse of affection may itself become an incentive to crime. At an older age, much that passes for sexual misbehavior is in point of fact inspired by the tender, protective elements of this quasi-maternal impulse. The boy is protecting his sweetheart; the girl, mothering her lover; and even their crude embraces are more those of parent and child than of paramours. In the main, however, it is a want of affection

---

<sup>5</sup> Drever, *loc. cit.*, p. 195. The word “love,” and even the word “affection,” suggest complex sentiments rather than simple emotions. “Tender emotion” is among contemporary psychologists the accepted term. At least one celebrated writer, Adam Smith, has attempted to base a system of ethics upon what he terms “sympathy” (*Theory of the Moral Sentiments*, 1770), and has traced vicious and criminal conduct to the absence or non-operation of the same feeling. Unhappily, his psychology is vitiated by a confusion of “tenderness” with true sympathy in its various forms, and particularly with that sympathetic induction of emotion which is a trait so universal in gregarious creatures.

rather than an abundance of it that marks the mental make-up of the typical delinquent.<sup>6</sup>

#### 14. Grief

Sorrow has been described as the "suggestress of suicide"<sup>7</sup>; and suicide in England is classed among felonious crimes. Self-destruction, however, is hardly to be counted an instinctive propensity, and some writers, following McDougall, deny to sorrow or grief the status of an emotion. Nevertheless, the majority add sorrow to their list of human feelings, and Shand even recognizes an underlying instinct as part of its mental mechanism<sup>8</sup>: to sob, to shed tears, to cry for assistance when distressed, as every child without exception does, seem the first rudimentary manifestations of an innate impulse of grief. This view seems best in keeping with popular usage. Accordingly, we may provisionally adopt it, and seek in the developed passion of despair the readiest explanation for those actual or attempted suicides which, rare as they are, form yet the saddest features of the juvenile court.<sup>9</sup>

---

<sup>6</sup> The heartlessness is often traceable to repression. Just as in the virtuous prude all vicious tendencies become repressed and break out in symbolic eccentricities, so in the criminal the more tender elements become outwardly inhibited and yet seek a way to vent and to reveal themselves through incidental impulses inconsistent with his ordinary life. This seems to be the explanation of the contradictory touches of sentiment that even the most cold-blooded murderers at times display. Thieves and prostitutes are notoriously liberal to street beggars and to each other in distress. Dostoievsky, in his *Recollections of the Dead House*, describes how, at the prison in which he himself was immured, every convict had his pet. Wainwright, the poisoner, had a fondness for cats. Eugene Aram had a tenderness for dogs and chickens. Laccenaire, on the very day that he killed a victim, had risked his own life to save a kitten from drowning. A German murderer, having butchered his fiancée with much savagery, went back to her house, at the risk of his neck, to free her canary lest it should starve in its cage.

<sup>7</sup> De Quincey, *Levana and Our Ladies of Sorrow*.

<sup>8</sup> *Op. cit.*, p. 317.

<sup>9</sup> A brief but helpful paper on this problem is that of L. M. Terman, on "Recent Literature on Juvenile Suicides" (*Journ. Abn. Psychol.*, IX, 1914, pp. 61-6). Of monographs dealing with the general subject, that of R. Gaupp, "Ueber den Selbstmord" (Munich: Gmelin, 1910) is perhaps the best. Morselli's book on *Suicide* (International Scientific Series, 1881) is mainly a compilation of statistics, and, like all statistics

The following is, in many ways, a typical case.

Violet<sup>10</sup> was a dark, dull-eyed, depressed-looking girl, nearly fourteen years of age, of rather more than normal intelligence, but of rather less than normal health. At school she was described as "delicate" and "somewhat quiet and doleful," one who responded warmly to praise, but was readily chilled by a rebuke. In the infants' department she was remembered as "a great cry-baby," but nothing of this habit was known or noticed by her present teachers. For three years her mother had been calling on the head mistress with apparently unnecessary complaints: Violet was disobedient; Violet was developing fits of temper; Violet was moody, melancholy, and moping, locking herself up in her room all day or threatening to fling herself into the Thames. These statements seemed so flatly contradicted by the child's demeanor at school that little attention was paid to them. At last, one morning during Sunday school, the mother, in wild agitation and distress, rushed in to say that Violet had taken poison.

The details of the matter I learnt from a later interview. It appeared that during breakfast Violet had looked more glum

on criminality, suggests problems rather than solves them. A valuable English study is Norwood East's report on "Attempted Suicide: with an Analysis of a Thousand Consecutive Cases" (*Journ. Mental Science*, LIX, 1913, ccxvi, pp. 428-77). For the standpoint of psycho-analysis reference should be made to the collected papers of Freud, Adler, Friedjung, *et al.* "Ueber den Selbstmord, in besondere den Schüler-Selbstmord" (Wiesbaden: Bergmann, 1910).

<sup>10</sup> Violet R. Age: 13½. Home Circumstances: Mother, office cleaner (£2 per week). Two older children (both earning, giving mother 10s. per week each). The family have 4 rooms (rent, 9s.). The house belongs to an uncle.

*Family History:* See above.

*Physical History and Condition:* Rickets, measles, diphtheria. After this last illness, "seemed weak," and used to talk in her sleep. Somewhat thin and anæmic: occasional headaches. Health otherwise sound. Nails badly bitten. Height, 145.9 cm.; weight, 33.8 kg.

*Intelligence and School Attainments:* Mental age, 14.5 (mental ratio, 105). Reading, 13.5. Spelling, 13.0. Composition, 13.3. Arithmetic, 12.8. Handwriting, 13.5. Drawing, 13.0. Handwork, 14.0.

*Temperament:* Emotional, sensitive, and repressed. Sorrowful disposition. "Father fixation," with some repressed antagonism towards mother and elder sisters. Mild anxiety symptoms (see above).



than usual, and her mother had spoken to her sharply. The child had at once dashed up to the top of the house, and after sobbing on the stairs for half an hour, had taken from her mother's washstand a liniment bottle labeled "Poison" and swallowed the contents. A doctor was fetched; an antidote was administered; and though the girl recovered, she was sick for several days and unable for a couple of months to go back to school.

On her father's side she had inherited a definite neuropathic taint. The paternal grandmother was in an asylum, suffering from religious melancholia, broken by suicidal and homicidal spells. The father himself had been a gloomy misanthrope and a heavy drinker of whisky and gin, brutal to his children and unfaithful to his wife; one night, when intoxicated, he had put a knife under his pillow (so it was said) to cut the throats of the whole family in their sleep. He died after a stroke of apoplexy on the eve of Violet's tenth birthday.

At first, it was far from easy to induce the girl to talk. All through our early interviews her face was never once lighted by a smile. As with most sensitive children, her inner thoughts and feelings could best be elicited by indirect analysis, by tracking to their sources certain secondary symptoms. I found that, in addition to her periods of dejection, she harbored a special terror of the dark, and it was the examination of this abnormal dread that at last laid bare the true condition of her mind.

In children recently bereaved, it happens not infrequently that the fear of the dark is at bottom a fear of seeing some one in the dark. This was so with Violet. She was secretly hoping and secretly afraid that some evening, when alone, she might meet her father's spirit. She treasured, she said, a vivid mental picture of "the way he used to look." Repulsed by the other members of the household, she would sob in a bedroom by herself and resign her mind to morbid daydreams, in which she held long colloquies in fancy with her father, telling him again and again how she "wished she was with him"—that is, how she longed to be dead.

Little as he deserved it, her devotion to her father was tenacious and profound. All but his rare acts of kindness she

had forgotten; the whispers of his cruel and eccentric conduct she took to be nothing but malignant lies. Always on her lonely Sunday afternoons—the day on which he used to take her with him for a walk—she missed him more bitterly than ever. To the rest of the family, the man's end had come as a grateful release; to them it would have seemed no less than ludicrous that he should be recalled with any sentiment of love; none of them had ever suspected that, for three long years, Violet had been pining in silence as a heartbroken orphan.

The mere unraveling of her motives, the mere confession of her hidden grief, was enough to dispel the fits of temper; she joined a troop of Girl Guides; learnt to play the cornet—an exercise which, though it can hardly have soothed the family, seemed to comfort her greatly in her disconsolate moods, and, later on, under the sympathetic handling of a visitor who sought her confidence and friendship, she gradually threw off her feelings of despair. Puberty she passed through with no serious strain, and now, though still somewhat weak in her physique, still a little grave and seldom gay, is wholly normal in behavior.

Among children of school age, suicide is exceedingly uncommon. The greater number of such youthful tragedies, in England and America, are met with at adolescence among girls. In most other countries self-murder bulks more largely among boys. Even in this country, before fifteen and after twenty—that is to say, except for the stage of adolescence—male suicides outnumber female at every year of life. Everywhere and at all ages, unexecuted threats far exceed in frequency the genuine attempts.<sup>11</sup>

The dull and the defective rarely destroy themselves. In my own list of would-be suicides the mental level is above rather than below the average, and the general type conforms pretty closely to that said to have been encountered by Prince Florizel at the Suicide Club: "young people in the prime of life, with every show of intelligence and sensibility, but with little promise of strength, or of the quality that makes suc-

---

<sup>11</sup> In the table (page 407) threats are for convenience classed with attempts.

cess."<sup>12</sup> With persons of this age and this mentality, the motivation is naturally somewhat mixed; besides sheer grief, many other feelings—fear, anger, sex, and a fantastic form of self-assertion that seeks its paradoxical end by destroying the self to be asserted—all blend with each other, making their contribution differently in different individuals. Indeed, as will be seen from the table,<sup>13</sup> I have never found a mere excess of sorrow working as a major cause.

Suicidal threats are so common and so disturbing that it is worth while to study at length the impulses that seem to actuate both sincere and feigned intentions of this kind. So far as my own few cases are a guide, the following are among the mingled motives to be discerned.

1. First, and at the youngest ages, there is the very general wish to punish others by forcing them to grieve over the victim's death; one bright little girl of ten, for example, tells me how she has long nursed visions of self-martyrdom, picturing herself in a flower-strewn coffin, with her parents and school companions shedding tears and snowdrops over her white-robed corpse. At times this daydream and the grievance underlying it would grow so insistent that the child began writing in her letters or exclaiming in her temper, "You'll be sorry when I'm dead"; then, nettled by her mother's gentle ridicule, she felt she could not leave her words to be laughed at as an empty menace, and with a sudden impulse, mortified by some reproof or penalty, tried to make good her thoughtless words.<sup>14</sup>

<sup>12</sup> R. L. Stevenson, *New Arabian Nights*, "The Suicide Club," p. 18.

<sup>13</sup> Table XVII, page 407.

<sup>14</sup> Guthrie records an even younger case, a boy of four, who, chidden for some fault, cried out, "I'll tumble head first out of the window, I will!" And had apparently to be restrained from carrying out his resolution (*Functional Nervous Disorders in Childhood*, 1909, pp. 100-101).

To the psycho-analyst the motivation of such youthful attempts is highly instructive. Often, in these earlier years, the impulse involved is self-directed anger more than sorrow or despair. It has been frequently observed that love for another may be based upon a primary love for oneself, the feeling being transferred or projected on to an external person. By a strange inversion of this common principle, a primary hatred for another may become secondarily reflected against the self; so that murderous and cruel impulses, aimed originally against

2. Grief arising out of the incidents of school life may form a second cause. Overpressure at lessons, failure at examinations, homesickness at a boarding school, are sometimes responsible for a resolve to die. But in this country such reasons seem rarer than elsewhere. In Prussia statistics collected during the last fifteen years of the last century report nearly a thousand child suicides, and of these a large proportion were stated to be boys suffering from worries about school work. But there is now a growing belief that the share of the educational system in producing such tragedies is, even in Germany, infinitely smaller than was at one time too hastily proclaimed.<sup>15</sup>

3. Certainly, in England, before the stage of puberty fatal attempts are seldom heard of. It is not until the age of fifteen that the figures begin rapidly to rise. During the later 'teens, indeed, dark thoughts and morbid utterances about death and

---

a parent, a rival, or even a beloved friend (for love is often linked with hatred), are vented upon the child's own person. Sometimes there is a perverted wish to be ill-treated and even killed by the person loved or hated, and the child, in a sort of fantasy, persuades himself (and sometimes others) that the self-inflicted wounds are, directly or indirectly, the work of his supposed persecutor. At an older stage, a half-conscious motive is to escape back into the heaven of infancy, where no efforts have to be made and every grief is soothed—in a word, to rejoin the mother. It is a motive which in the orphan boy may become clearly conscious and easily intelligible, and which we have already encountered in a cruder form in the orphan girl described above. Like Oliver Twist in the workhouse cemetery, they are silently praying to be reunited to a lost parent.

<sup>15</sup> In England it is worry and overwork at home rather than at school that are more likely to tempt the child to such extremities.

As these sheets are going through the press, the following case has been brought to my notice. Ellen J., aged thirteen, attending a London school, suddenly disappeared from home, and her body was found in the Thames one Saturday afternoon. The father was a steel-work erector in fairly comfortable circumstances. There were four other children. The mother had died eight weeks before. Since then Ellen had "tried to run the home." The father stated that the only cause he could assign for the child's act was "worry": "she got muddled with the housekeeping money." A day or two before she disappeared he had "smacked her" because "she had only a few shillings left out of the £3 he had given her ten days previously for the rent and the children's food." The finding at the inquest was that the girl "killed herself while of unsound mind."

self-annihilation are the rule rather than the exception. Sometimes a too curious youth will experiment with pistols, poisons, or nooses, to bring home to himself more keenly what the approach of death must feel like; occasionally the experiment is pushed too far, and he satisfies his last curiosity. Now also the young adolescent finds in the broadening duties of existence a load too heavy to shoulder; from the responsibilities of manhood he turns away shrinking; his own life, he feels, is doomed to be a trial to others and a torture to himself; never can he prosper as he has desired. There may, besides, be bitter regrets for former failures, remorse for bygone sins, and all the torments of a tender conscience. Every wish, every idea, every aspiration seems frustrated, and the one course left to the disillusioned pessimist is to put an end to life and misery together.

4. Later yet, fourth in our catalogue of motives as fourth in Hamlet's list, come "the pangs of despised love."<sup>16</sup> Jealousy of a rival, chagrin at rejection, despair at a bereavement, and, with unmarried girls, the shame of impending pregnancy may lead, no longer to empty threats and half-hearted endeavors, but to sudden and effectual acts. Most pathetic of all are the melodramatic attempts at double suicide. Because of the youthfulness, it may be, or the social inequality of the loving couple, their families oppose the courtship; and the pair drink salts of lemon or drown themselves together. A book, a film tragedy, or a newspaper narrative often suggests a method to the impressionable and imitative mind, and so at times there comes a wave or epidemic of lovelorn adolescent cases, with a definite fashion in the manner of death preferred.

5. Among older persons, suicidal tendencies are at times associated with a particular form of insanity—melancholia; but it is hardly necessary to add that psychological writers, unlike the coroner's jury, connect such actions with unsoundness of mind only in specific and exceptional cases. Among youthful suicides, actual insanity is rare; but hysteria, particularly at or

---

<sup>16</sup> We have already encountered such an instance in examining the history of Jim M. (Chapter VII).



just past the age of puberty, is by no means unusual; and, in the guise of an anxiety neurosis, may wear the appearance and get the name of "melancholia."

Most threats are to be received without too much alarm, seriously, of course—that is to say, without derision, but not with the apprehension or dismay that they so often arouse. As with all forms of intimidation, the element of anger and the desire to vex play here a considerable, if not the main, rôle. The difficulty is to discriminate the threats that may be put into execution from those that certainly never will. The only clue is a close study and a dispassionate balancing of the motives apparently at work.

### 15. Joy

The foregoing cases are exceptional. Most young criminals are by nature merry rather than melancholy, sanguine rather than sad. How often is it reported that the delinquent child is without remorse or regret and shows neither penitence nor sorrow for his faults. "My own child," said one head teacher to me, "wept for half an hour, when she had broken another child's doll by accident; this little thief has spent all her mother's wages on sweets and toys and still goes skipping about, though the whole family has now to starve for the remainder of the week."<sup>17</sup>

In the prison, the remand home, or the examination chamber, the young culprits may wear an anxious and lugubrious look. But amid their natural surroundings and in their day-to-day behavior, they are, as a rule, cheerful little creatures, smiling, sniggering, simmering over with gayety, ready to seek and find fun everywhere. They have a high capacity for

---

<sup>17</sup> Such parallels, often as they are drawn, are not entirely just. In the instance cited, the thieving spendthrift had the same chronological age but not the same mental age as the teacher's daughter: indeed, she hardly possessed enough intelligence to comprehend the plight her pilfering had brought about; certainly, she had not enjoyed the same regular training in consideration for others. Moreover, the very fact that the theft is the outcome not of accident, but of desire, yields a positive satisfaction at its success, and so is likely to smother any remoter twinge of grief. But, in all such cases, it should be remembered that

enjoyment, and are sometimes demonstrably insensitive to pain. Often it is nothing but this insatiable appetite for pleasure, together with the strong habits which pleasure builds up by fixing firm all pleasure-yielding tendencies, that is to blame for their undoing. This susceptibility is one of first importance for discipline and treatment. Most of these youngsters are influenced by pain far less than by happiness, by punishment far less than by reward, and yet too often pain and punishment are the only modes of training to be tried.

## 16. Play

Play, the characteristic occupation of childhood, is not so much a separate instinct as an hereditary mode in which almost every instinct may become active. Partly it consists, as the poet Schiller and the philosopher Spencer alike have pointed out, in an overflow of excessive animal spirits, a spilling of superabundant nervous energy, which in the brimming state of careless dependence are not yet wholly drawn off and absorbed by the serious struggle for existence. Play is this; but it is something more. A human being, unlike the ant or the caterpillar, is born half-made. His instincts are undeveloped buds, to be matured and ripened by practice. The age of play is his apprenticeship to life. It affords him a valuable gymnastic by which his slowly emerging mechanisms may be tested, tried, and trained—a series of long rehearsals in which they can be exercised and modified during the earlier years of tutelage for the later years of self-support. In the young much seeming criminality is simply play, or a pitiable substitute for play, having this origin and this purpose; and, were it not harmful to the community, would prove a natural source of serviceable experience to the experimenting individual.

---

the greatest tact is needed to elicit any outspoken words of contrition, which may yet be felt in secret and with sincerity. To lecture the child on the duty of remorse is simply to provoke bluff and bravado, not sorrow or shame. As Dostoievsky, a profound student of the prisoner's heart, has somewhere observed: "With criminals assumed penitence is seldom real, and real penitence is never obtrusive" (*Recollections of the House of the Dead*).

### Conclusion

These, then, are the instinctive tendencies which criminals, in common with all mankind, inherit; and these the chief directions in which such impulses, shown now to excess and now in deficiency, motivate the commoner offenses of the young.

It will be observed that it is chiefly, but not entirely, the strong or "sthenic" instincts—anger, acquisitiveness, assertiveness, and sex—that figure as incitements. The weak or "asthenic" instincts—tenderness, submissiveness, grief, and fear—being inhibitory rather than provocative in their immediate tendencies, hardly ever act alone as the final precipitating cause.

This distinction throws light upon the remarkable disparity in criminal habits to be observed between the two sexes. Broadly speaking, in this country there are nearly four times as many male criminals as female<sup>18</sup>; and though the divergence may be smaller at the younger ages, and though it varies appreciably in other countries and with the varying definitions of crime, it still remains, of all mental differences between men and women, the most salient and the most definitely proved. Now criminality itself, as we have seen, is not an innate quality of mind. Is there, then, any quality more radical with which this difference may be joined? One inborn sex difference alone is at all well marked and well established,<sup>19</sup> and that is the difference in emotions and instincts. What I have called the strong or sthenic emotions are more pronounced in the male, whereas the weak or asthenic are more pronounced in the female. It is

---

<sup>18</sup> According to the latest available statistics, the returns for convicted criminal prisoners during the year 1922-23 included 37,336 males and 10,035 females; during the year 1922 there were 2,424 boys and 186 girls in reformatories and 5,420 boys and 1,479 girls in industrial schools. Thus, the proportion of females was 21.2 per cent among adults, 7.1 per cent among young persons, 21.5 per cent among children. In London, among the total industrial school cases reported, as distinct from those committed, the boys number nearly nine times as many as the girls. At the ages below ten, however, the sex difference is very much smaller, and if we could compare, not cases officially reported, but cases known to teachers, the contrast would be smaller still. Indisputably, however, the males are throughout in excess.

<sup>19</sup> See Burt and Moore, "The Mental Differences between the Sexes," *Journ. Exp. Ped.*, I (1912), pp. 273-84 and 355-88.

the former, as we have just concluded, that are chiefly responsible for criminal offenses; and thus the excess of criminal offenses among males seems in part accounted for by the excessive strength of their aggressive instincts.<sup>20</sup> Moreover, there are minor differences in the specific crimes committed by males and by females respectively—boys, for example, being far more prone to violence, truancy, and stealing, girls to sex offenses and untruthfulness;<sup>21</sup> and these differences in turn correspond with the differences in strength with which either sex inherits each motivating instinct. Here, therefore, we have an incidental confirmation of the instinctive origin of crime.

### Treatment

To append, under the heading of each particular instinct, detailed indications for treatment and training, I have not thought necessary. Such a course might have conveyed that the matter is much more simple and mechanical than it really is—as though each offense had its own instinctive impulse, and as though each instinctive impulse had its own specific cure. For all emotional tendencies the broad principles of training must be much the same, and further elaboration would have been beyond the space at my command. Half a dozen general suggestions may be briefly put together here.<sup>22</sup>

#### 1. The Fallacy of Hedonistic Penology

In the first place, the analysis that has been given allows us to appreciate more readily the unconscious processes at work,

<sup>20</sup> I do not suggest that this innate difference provides the sole explanation. Tradition and social influences undoubtedly play their share. Still more, the inevitable differences in the parental complexes formed by sons and daughters respectively have important effects upon subsequent behavior (see below, Chapter XII, page 523). Yet even these differences, in the last resort, spring largely from an inborn sex difference in the emotions.

<sup>21</sup> Compare, in Table I (pages 14-15), the two columns for offenses of boys and girls respectively; also the figures for the industrial and reformatory school cases reported to the Council, *London Statistics*, XXVII (1922), pp. 189-90, and the figures given in the *Report of the Commissioners of Prisons* (1923), pp. 14-15.

<sup>22</sup> Of the innumerable attempts to base normal education on a sound

with effects so strange and so disastrous, in the mind of the young delinquent. It aids us, therefore, to meet him at once with a fuller understanding and a wider sympathy, and treatment is placed on a scientific footing. Here, more than anywhere else, the biological view of human life provides a needed corrective to popular theory.

The traditional psychology of crime on which most of our practical measures hitherto have been tacitly or expressly based, so far from being helpful, is in many points lamentably misleading. It is an almost universal view that criminals (and, for that matter, human beings generally) are moved simply by pain and pleasure, or rather by the results of a nice calculation of the balance of pleasures over pains. The youngest infant is depicted as a rational hedonist, a utilitarian philosopher in miniature. Of such a doctrine the corollary is as clear as it is fallacious. If any particular child is animated too powerfully by a desire for his own private happiness and so is induced to seize more than his own just share, the right course would be to mete out to him an extra allowance of suffering. This added pain or punishment must redress the unequal scales; the child, it is supposed, will shrewdly note the altered incidence of comfort and discomfort, and will, as in reason bound, avoid any renewal of past aggressions since they now bring with them more misery than joy.

In sharp antithesis to this accepted view, we have come at length to understand that children in general, and criminal children most of all, are swayed by no such intellectual compunctions. To total up contingent gains and hypothetical losses and subtract the one sum from the other, is a form of moral bookkeeping for which none but the most far-sighted epicurean would have patience. The youth who gives way to a sudden gust of anger, the girl who succumbs to the physical promptings of sex, the infant who goes wandering away through a maze of

---

psychology of childhood, perhaps the best and most eclectic is that contained in Stanley Hall's chapter on "Moral Education" (*Educational Problems*, 1911, Vol. I, Chap. v). Other chapters from the same suggestive work may be read in this connection with profit, particularly those on "The Educational Value of Dancing and Pantomime," "The Pedagogy of Sex," and "The Budding Girl."



streets, are none of them deliberately prosecuting a carefully thought-out design, buying at the price of tolerable trouble an added increment of calculated bliss. They are urged, as it were, violently from behind, pushed blindly on by an unreasoning instinct to an unforeseen goal, half ignorant and wholly careless of the remote results of their semi-reflex impulses. Pleasure, no doubt, plays its part. After the first occasion on which the inborn instinct has exercised itself successfully, the pleasure attached by nature to the consummation of every instinctive act, together, perhaps, with a dim anticipation of future joys from similar proceedings, may tend to drive home the inherited tendency as a fixed and permanent habit; but this is an incidental and a secondary effect. It is neither the earliest motive, nor yet the most potent. The real fount of energy is the natural instinct, with its concomitant emotion. Accordingly, the impulsive criminal—the delinquent, that is, whose crimes are instinctive and not deliberately planned—is to be approached more as an animal than as a hedonist, more as an emotional mechanism than as a calm and logical reagent. We must consider that he is liable always to be spurred fatally onward by some natural force—a force which closely resembles those vital springs that animate the humbler brutes, a force which is a part of our common human nature, but which he, in particular, inherits to a magnified degree. Of the nature of that force, and even of its existence, he is all but unaware.

## 2. *Sublimation, Not Suppression, of Provocative Instincts*

It follows from this view that one easy way of deflecting tendencies to crime is to provide at an early stage less harmful outlets for these crude instinctive ebullitions. The diversion of emotional energy from the lower forms of instinctive behavior into higher interests that shall be at once legitimate and beneficial to society is sometimes termed "sublimation"—a useful term for a useful principle.<sup>23</sup> Since the antisocial actions are themselves inherited, they will prove usually to be as persistent

---

<sup>23</sup> In psycho-analytic writings the term is generally restricted to the transformation of energy that is primarily sexual and has become re-

as they are impulsive. Hence, the change must be gradual. An abrupt reform is rarely to be looked for; a sudden conversion will seldom last. The new leaf that the child is told to turn over must always show the dents from the black marks on the preceding page. Thus, the moral advance that we try to stimulate can never be a leap from something wholly discarded to something altogether new. The stepping-stones to higher things are never our dead selves; our living past survives within us however much we grow and alter.<sup>24</sup>

Sheer, uncompromising suppression, therefore, is likely to be unavailing, and often worse than unavailing. Whether the offender be punished or not, whether or not he be segregated or imprisoned, all purely negative measures should be supplemented by positive and constructive efforts of assistance. His emotions must be trained as well as his intelligence; his instincts must be educated as well as his wits. Most juvenile delinquency is, in the last resort, the effect, not of weak or willful sinning, but of misdirected energy, and is to be cured, not by an effort to stamp out that energy (a stark impossibility) but by directing it anew and guiding it aright.

This amounts, in effect, to a kind of homeopathic treatment for crime. The principle is a sound one. How it should work in practice may best be understood from its application to four or five of the more typical and troublesome propensities—such as theft, anger, wandering, and sex.

### 3. *Treatment of the Acquisitive Impulse*

To the covetous thief the psychologist will seldom preach that his coveting is wrong and that with one strong exertion of will it should be given wholly up. To demand that is to demand

---

pressed. Where repression is at work, active treatment must be employed: for the energy can never be side-tracked until it has first been released. If the energy is already locked up, the mere passive provision of counter-interests is of little use. The key must be turned before the door will open.

<sup>24</sup> This axiom is nowhere put so clearly as in Professor Nunn's *Education: Its Data and First Principles* (1920), and the moral educator could have no wiser textbook. Both here and in other places I have borrowed much from his exposition.

the impossible. It is to ask the fish to soar like the bird or the beast of prey to lie down with the lamb and chew nothing but green blades. The true course is not to crush but to countenance the child's natural impulse, and that to the furthest limit which proves feasible and safe. The acquisitiveness of the acquisitive youngster may be positively fostered; only he must be induced to be acquisitive in the right way. It is common practice, when a boy has stolen, for his parents to stop his pocket money, thus, illogically enough, supplying him with an additional incentive for stealing afresh. To urge that his pocket money should be, not docked, but doubled, may seem paradoxical. Yet the readiest way to cure the robber is to use him with unexpected generosity: give him, not only pennies to spend, but sixpences to save and a cash box of his own to lock them in. Ownership is the best school of responsibility and faithfulness. To have property oneself is a sure way to learn respect for the property of others; *tuum* and *suum* are best taught by *meum*. Stealing is the vice of the unowning and the dispossessed.<sup>25</sup>

---

<sup>25</sup> It is sometimes said that the distinction between *mine* and *thine* is not to be expected of the very young child. With normal children, as distinguished from the dull and defective, this is untrue. The sense of ownership, as careful study has shown, may be developed among infants of quite tender years (see Kline and France, "The Psychology of Ownership," *Ped. Sem.*, VI (1899), pp. 421-70). A close analysis of most juvenile thefts will show that nearly every thief preserves some measure of regard for the rights of others. After all, there are degrees of ownership. The man who would never steal from his neighbor's table will yet defraud the railway company or the income-tax collector without a scruple and steal notepaper from his club or his hotel without a qualm. To rob an impersonal corporation, an unknown stranger, or a foreign foe, is everywhere held more venial than to rob a friendly host or guest. These shades of difference the child very quickly appreciates, but he chalks the line from a different point. He will steal a pencil from his teacher who keeps a hundred in a box when he will never steal it from another child who has only one or two. He will steal a shilling from some subscription fund as belonging to no person in particular, but would never set a finger on it while it remained the property of some individual owner. Should the butter he is buying for his mother cost a penny less than his mother assumed, he may keep back the change, but he would never take the same amount from a cash box or a till. There is honor of a kind among most young thieves, and none but the most hardened will defraud a popular school-

But to acquire is not merely to hold: it is to earn and to accumulate. Should you simply put a shilling into a lad's hand before his hand finds its way to your pocket, your act will afford him but half the satisfaction. The progressive joy of slow, ingenious acquisition is altogether missed. Some task or enterprise bringing quite as much excitement as a burglary and needing quite as much dexterity as cracking a hard crib must be arranged for him. Where the stealing is provoked by a desire for some legitimate enjoyment—for toys, for sweets, for fruit, or for the cinema—his longing should, so far as possible, be gratified, but gratified on conditions. Often the reward can itself be made contingent upon a stiff and stipulated course of honesty. A child dearly loves a bargain; he will respect it, when he will never respect a legal obligation which he cannot comprehend and to which he was no consenting party. Professor Stanley Hall quotes a diverting illustration of this method from his own successful experience. Summer after summer, while he himself was away on holiday, the boys from the neighborhood raided his orchard. "The professor," said the ring-leader, "has no business with two homes, when he can only use one at a time." Professor Hall convened the little gang and told them, as the Lord did our first parents, that they might take the fruits of all the trees but one, provided they would save that one for him. They not only kept their compact loyally, but protected his chosen tree, together with the rest of his grounds, from every other intruder.

#### 4. Treatment of Truancy and Running Away

The truant and the wanderer are less annoying than the thief, but often harder to comprehend. Here, perhaps, more than with any other offense, the causative factors are manifold; they are certainly more obscure: and subjective and objective conditions are intricately laced together. Once again, therefore, the hidden or perhaps half-unconscious motives have first to be

---

mate, a benevolent uncle, or a poor widow whom they know and respect. Primitive as they are, these ethical discriminations should be sought for, recognized on their merits, and utilized as a foundation upon which a wider sense of responsibility may be built.

fathomed, and then furnished with forms of satisfaction less precarious.

As we have seen, the typical truant of today is the small child of seven or eight who has exchanged the freedom of the infants' department for the sedentary discipline of the seniors' and who has grown too big to be content with crawling about in the house or playing in the yard. At school he feels screwed down on to the bench, just as the bench is screwed down on to the floor. At home he is cooped up in overcrowded quarters, with hardly more room to move his legs than in the classroom, and his mother makes it a point of family pride never to let her children out into the street. In such a case, it is little wonder that the locomotor impulses are exercised furtively and in defiance of recognized rules. No sooner is he on his feet in the morning than his feet seem impelled to carry him much farther than the school gates; he shirks attendance and runs off.

In these plainer cases the remedy follows at once from the precepts already laid down. Allow the child, both at home and at school, a wider range for his roving impulses. Nature has given him muscles and therewith the tendency to use them. Why should he not have scope and liberty to run about, as much in civilized life as in that state of savagery which, at his years, would be more natural?

But the simple case is the rarity. Too often, because truancy sounds a trivial offense, to be dealt with upon summary lines through the attendance officer, the real cause is missed.<sup>26</sup> In

---

<sup>26</sup> Truancy of itself seldom forms a sufficient ground for committing a child to an industrial school. Where, however, the truancy is likely to lead him into more serious offenses and he cannot be controlled at home, there a residential school is the best place for him. In London the experiment has been tried of committing serious and persistent truants to a selected school for a short term only. Such children may be licensed out after a month's detention on the condition that they regularly attend an ordinary elementary day school. An alternative plan that has been employed, not always with great success, is the establishment of day industrial schools. In such schools the children are provided with industrial training, elementary education, and one or more meals a day, but not lodging. Any child liable to be committed to an *ordinary* industrial school may be committed to a *day* industrial school. The majority of the committals, however, have been for non-attendance at the ordinary elementary school. Except for two such schools main-



many, if not most, the universal instinct to wander is no more than the immediate, actuating factor: why is this instinct set thus defiantly in motion? why are the normal outlets not sufficient to use it up? Ascertain, to begin with, what he does when he is away on his favorite jaunt. Once he has run off, he meets, no doubt, with joys and experiences he has never known before. By the simple law of pleasurable returns, the instinctive tendency is thus stamped home. Since he is scolded and rebuked, his future escape must be more cunningly contrived. Soon, too, he acquires some abiding interest which adds a further incentive—playing with street companions, slipping into the picture palace, gazing at the shop windows, seeing the sights of the East End docks or the West End theaters. Again, these special interests should be accepted rather than combated, and the boy should learn that they can be more richly gratified when they are pursued in a lawful way. Walks and expeditions with his parents or with his older friends and relatives, school journeys, Boy Scout marches, excursions to places that appeal to him in or around the city—these are simple activities that can usually be arranged with ease.

In every case of truancy, and most of all in the more hardened, a full study must be made. The child's health, capacity, and disposition, the intelligence, character, and disciplinary methods of his parents, the facilities, teaching methods, and personnel of his school, his companionships and pastimes outside the school and home—all must be reviewed. With older children more particularly, it is essential to search for some secret instigating factor—the fancied injustice or jealousy, the latent hostility to teacher or parent, as well as the various instincts, interests, or feelings which incidentally derive a satisfaction during these runaway spells. It is particularly helpful to look where the limitations press most severely—whether

---

tained by the local authority at Liverpool, all day industrial schools have now been closed. In actual practice, where the parents are away during the daytime and the child seizes the dinner hour as an opportunity for mischief, it often proves possible to arrange that he remain for the midday interval on the premises of the ordinary elementary school. Special schools or special institutions are needed, therefore, only as a last resort.

home or school cramps him in most. At school he may be despised as the duffer or the restless nuisance of his class. If so, he should be removed either to a different class where his dullness or backwardness will be less apparent and where he will no longer chafe under a growing sense of scorned inferiority, or else to a different school where discipline is freer and teaching methods admit more activity and movement. For the master, the best rule is this: make school life so attractive that these young defaulters actually prefer lessons to truancy, the classroom to the street. At home the situation may be harder to deal with. The monotony of family life may be so dull and deadly that the street is by comparison a paradise of fun. With a little judicious advice and perhaps some financial help, the parents may be brought to make existence indoors more tolerable. Out of doors, there may be some play center, club, or recreation ground, which he may be encouraged to frequent.

#### 5. Treatment of Angry Impulses

According to the maxim of one of the seven wise men of Greece, anger is to be classed as the worst propensity of human nature, "the chief enemy of public happiness and private peace." Seneca and the Stoic philosophers urged its complete eradication. Yet Plato and Aristotle held that anger had a value and thought it a spur to noble indignation and to deeds of valor and strength. The teacher and the parent are usually with the Stoics: the contemporary psychologist, with Plato and his school. McDougall has shown how civilized society would be, in fact, the loser, could anger, instead of being cultivated and trained, be rooted out forthwith.<sup>27</sup> "Anger" (if I may quote Stanley Hall once again) "should be a great and diffused power in human life, giving it zest and force. It requires for its culture a proper selection of its objects, and careful transformation, but never extermination."<sup>28</sup>

After all, the very attempt to repress it, as a rule only stirs up its violence. To be angry with the child because he him-

---

<sup>27</sup> See *Social Psychology*, pp. 280 *et seq.*

<sup>28</sup> *Adolescence*, Chap v, "Juvenile Faults," p. 355.

self is angry is to add fuel to his rage; to punish him is to prolong hostilities: the child feels that you are visiting your annoyance upon him and sees no reason why, to keep scores even, he should not revenge himself on you for seizing your own revenge. Nor is it likely that legal penalties will be more efficacious than domestic: they but turn the edge of his fury against society instead of his victim. With younger children, to neglect and ignore the impulse may often be the wisest attitude; but with older children the instinct must be taken more resolutely in hand; at these later stages, merely to humor those who are violent and to indulge those who sulk may be as fatal as a rash attempt at ill-considered control. The worst course of all is first to provoke anger by refusing concessions, and then to give way after anger has been roused. Never should a child imagine that he has only to fly into a passion, frighten his mother and disturb the neighbors, for his smallest caprice to be satisfied. A bad temper is often no more than a bad habit, and, like all other habits, it becomes fixed because it has served in the past to gain some end and has been regularly repeated with success. So far as possible, whatever is likely to precipitate a storm should be deftly avoided beforehand. Anything that heightens physical irritability or weakens nervous control should be sought out and remedied; simple prophylactics, like good food, fresh air, and careful measures of hygiene, are often sufficient to make the peevish contented and the boisterous calm. But, once more, the main measure is to supply a wholesome outlet. For anger and pugnacity the best channel is the most instinctive, namely, vigorous bodily reaction. Strenuous games like football, energetic boxing with gloves, and athletic exercises of every kind, provide loopholes for combative excitement, and at the same time train the impulses of strife and rivalry to keep well within the sporting limits of the game.

#### 6. Treatment of the Juvenile Gang

The child who is led astray by his gregarious or social propensities may be dealt with upon similar lines. The most natural course has been indicated more than once: it is to take the child out of the criminal gang and place him instead in some

wholesome corporate group. In London most juvenile cliques are casual associations rather than organized bands. Yet the very looseness of the union may blind both parents and officials to the extreme difficulty of breaking it up.

Various methods may be tried. The first and the commonest is also the most ineffective, namely, the occasional arrest of single members who are held to be ringleaders or happen to be the most easy to capture. Little more than this can be done by the police; yet it is often worse than useless. The troop as a body still survives; they revel in the thought that their partners have been unequally treated. The boy who is caught and the boy who escapes can both of them boast of their experience, and with those who have been selected for punishment, the mere fact of being punished or of suffering in common strengthens rather than destroys the ties that unite them. It becomes, therefore, essential to see and study, not merely the isolated offender, but every individual of the crew; the combination must be recognized and dealt with as a whole. For this prolonged inquiry will be needed, since in organizations so weak, it is, as a rule, but a small fraction of the total crowd that is likely to be concerned in any single escapade.

In most instances, by far the best procedure is to break up the ring by dispersing the confederates once for all. This can only be done effectively by persuading or compelling the various families to move from the district. Often, however, the parents will refuse. They will think it sufficient to warn their children never to mix with known bad companions, and fail to realize the influence which habit, sympathy, and a common outlook exercise over the feebler minds. In such a case the situation had better be dealt with through the court, and the majority of the gang must be committed to a residential institution. It is, too, an obvious precaution, though often neglected, to dispatch the various members to separate places instead of sending them all to the same place together, where once again they will combine in a body, stronger and more stubborn than before.

Occasionally, where the group is small and its career has been brief, it may be sufficient for the various parents to meet

for informal consultation and so find some simple remedy through coöperative action. Of course, the mere existence of such a lawless horde reflects gravely on the conditions in the neighborhood, and unless those conditions are mended, a new coalition will form as soon as the old has been scattered. Thus, the only permanent measure will be for the older and better elements in the community to organize counter-attractions throughout the district—clubs, athletic societies, recreation centers and fuller opportunities for social amusement.

### 7. *Treatment of Sex Impulses*

Principles such as the foregoing may likewise be applied to the treatment of other impulses—sex, self-assertion, and the excessive inclination to sheer play. To shut up the over-sexed girl away from all contact with men or boys, even were it practicable, would neither cool nor correct her sexual ardor: it would simply drive it in upon herself. Sexual excitement of some sort she must, will, and assuredly may have. Should we permit no opportunity, she herself will hunt it out. Hence, if we step in at the right moment and provide the occasion ourselves, we shall be sure of providing what is sound and salutary. This and all other impulses we may, when we wish, long-circuit—so generating light instead of heat. Without such provision, short circuiting is inevitable and a conflagration must ensue.

Sex instruction, always a delicate task, may be requisite for some. For others, all that is needful is a legitimate chance to enjoy their ordinary pleasures in the company of the opposite sex—playing and working side by side, as girls and youths in a civilized world may safely and allowably do. It will be prudent, as a rule, to keep some other interest or instinct active at the same time, so that sex alone is never uppermost, exciting and engrossing all physical and mental energy.<sup>29</sup>

---

<sup>29</sup> For detailed suggestions the reader may again be referred to Stanley Hall's chapter on "The Pedagogy of Sex," *loc. cit. sup.*, pp. 388-539. The special treatment of the adolescent girl whose sexual instinct is heightened by physiological precocity and over-development I have already touched upon (see Chapter V). Instructive cases and suggestive recommendations will be found in W. I. Thomas's recent book on *The Unadjusted Girl* (Criminal Science Monographs, No. 4, 1924).



### 8. *Encouragement of Inhibitive Instincts*

As we have seen, not every instinct is by its own nature vicious or dangerous. The restraining instinct of fear, the protective instinct of tenderness or affection, the fastidious instinct of repugnance or disgust—these may all help to inhibit the more vehement impulses that make for active aggression. By fostering those gentler passions and by training them in fit directions, strong forces may be built up to oppose and neutralize from within the more selfish, antisocial tendencies of unmitigated anger, acquisitiveness, or sex.

### 9. *Need for Mental Occupation*

Idleness is the one thing that it is essential to avoid. Emotional children must be kept sedulously busy. The chief enemy of virtue is not vice, but laziness. Mechanical drudgery at abstract tasks or hated housework is not real activity for the volatile delinquent. If no interest is kindled, no enthusiasm stirred, the mind closes its eyes and droops into a sensuous dreaming. Jerked by a sharp word back to the humdrum once more, it wakes up, not to a love of labor, but to a positive abhorrence for its everyday task. Room must be found in the child's life for cultivating each natural proclivity by hard but congenial work. Every portion of his mind, every inmate of that menagerie we call his soul—each appetite, each passion, each potentiality—must be called out of its cage into the open; hunted down if it be restive; harnessed in a full team and forced to draw its share. To reiterate the useful catchwords of the psycho-analyst, sublimation, not repression, must be the invariable aim. Our common human emotions form the only basis for our worldly life. Character rests upon instinct as a statue upon its plinth, and upon the same pedestal it is possible to set up either a Priapus or a chaste Diana.

## CHAPTER XI

### GENERAL EMOTIONAL INSTABILITY; HABIT FORMATION

So well he acted all and every part  
By turns, with that vivacious versatility,  
Which many people take for want of heart:  
They err; 'tis merely what is call'd mobility,  
A thing of temperament, and not of art,  
Though seeming so from its supposed facility;  
And false—yet true; for surely they're sincerest  
Who're strongly acted on by what is nearest.

BYRON.<sup>1</sup>

### GENERAL EMOTIONAL INSTABILITY

*General Emotionality.*—Hitherto I have spoken of the several human instincts, with their corresponding emotions, as if each were inherited in almost total independence of the rest. This is hardly true. In actual fact, as statistical analysis has proved, an excessive liability to one particular instinct tends (at all events, as a general rule, though not of necessity in any single individual) to be accompanied by a liability more or less excessive to most of the remainder. The correlation is clearer among children than among adults, and among delinquent children than among virtuous. The boy who steals is nearly always secretive, usually disposed to petty sexual faults, often a truant, not infrequently quarrelsome and spiteful, and yet sometimes, incongruously enough, an arrant coward, and easy dupe, spasmodically generous, warmly affectionate, and prone to heartbroken tears of remorse. Thus, as with intellectual capacities, so with emotional: a single central factor pervades them all. The central factor underlying intellectual processes has been described as “general intelligence.” The central factor underlying instincts and emotions may be termed “general

---

<sup>1</sup> *Don Juan*, Canto xvi, stanza 97.

emotionality," and persons whose general emotionality is developed to an exceptional degree may be designated technically "unstable."<sup>2</sup>

### The Unstable Child

No clearer instance of the unstable child could be found than Jerry Jones, the little murderer of seven, with whose story these chapters opened. The reports that I still receive upon his progress month by month demonstrate most plainly with what exceptional strength each one of his animal instincts is developed. From every home, from every school, from every institution to which he has been sent, the comments are the same.

He is, to begin with, desperately hot-tempered and pugnacious. It is a trait his mother has noticed from the first weeks of his infant life. "On the least provocation," says one report, "he kicks, punches, and hits out at the other tiny children"—"fighting," as another report observes, "like one possessed." "Time after time he is the first to cause a quarrel." Each teacher who has charge of him quickly finds that "it is really unsafe to leave him alone with other children." He is destructive, and that to a degree often amounting to callous cruelty. He is perpetually smashing his playfellows' toys, has tried to roast a kitten on the stove, and has battered a live duck's head upon the ground. Taking a silkworm moth in his hand one day, he smiled mischievously and saying, "Oh, the dear little thing,"

---

<sup>2</sup> The hypothesis of a central emotional factor I have endeavored briefly to formulate, on the basis of statistical correlations, in a paper read before the British Association (*Annual Report*, Manchester, 1915: "General and Specific Factors Underlying the Primary Emotions"). The conception of "the unstable child" I have sought to delineate in concrete detail in a paper with that title (see *Child Study*, X, 1917, pp. 61-78). More recently Dr. Florence Mateer, working as psycho-clinician with Dr. Goddard at the Ohio Bureau of Juvenile Research, has issued a volume on *The Unstable Child* (1924) in which she recognizes, as we have done, two main aspects of the mind, terming them "level" and "functioning," rather than "intelligence" and "temperament," and treating mental instability or "misfunctioning" (which she prefers to name "psychopathy") as the "chief source of unbalanced behavior in troublesome and delinquent children."

suddenly closed his small fist tightly upon it, to the horror of the children round him.

Many of his antics spring from sheer self-assertiveness and a love of self-display, a madcap desire to shock and show off, and generally to create a sensation. He has won many young hearts by his daring feats in climbing trees and by his dexterity in turning somersaults—always, of course, in public. But his love of domination leads to every sort of wild extravaganza. At one residential school the climax came when he climbed on to the roof of the woodshed with the ax in his hand and for a quarter of an hour terrorized all below, boys, girls, and teachers alike, threatening to “do in” any who approached him. After that an urgent telegram was received in London begging for his speedy removal.

We have already seen that, before he was sent into the country, he was disposed both to steal and to play truant. In the freer atmosphere of a rural home these propensities have caused but little trouble. He still loves an exciting ramble. He is still apt to snatch food and playthings from his companions. But money he now never takes.

Like so many young delinquents, he has shown, even at this early age, the instincts of sex. When he was but six years old, his first head mistress had remarked his indecent habits with little girls, and at his first residential school the superintendent again wrote that “on one occasion at least” he was found repeating his improper practices. At his present home, I notice, it is a girl who is his favorite playmate.

Nor has he much power of control over his simpler physiological impulses. There have been frequent protests because of his incontinence, which has shown itself in each of the usual forms. He is always hungry, and will pick up a rotten apple and munch it ravenously or grab a cake or bun from the next child’s plate.

Yet, amid all these unpleasant and aggressive traits, he also exhibits, with the queerest mutability, all the gentler emotions—fear and affection, submissiveness and grief—each developed in the same exorbitant degree.

His inborn timidity, so out of keeping in a would-be devil-

may-care desperado, crops up in quaint and unexpected ways. On the farm he was greatly scared by the cow. "'Twouldn't bite, would it?" he asked—"No."—"Not if you called it nimes?" Much of his outward aggressiveness, indeed, is at bottom traceable not to pure temper, but to a strong admixture of nervy alarm. His vindictive outbursts come most easily when he is frightened at impending punishment or when he is afraid lest another child should complain about his thefts or seek to reclaim some toy that Jerry himself has taken.

Although, since my first investigation, little or no reference has been made to the original tragedy, nevertheless it is always near the surface of his mind. A year afterwards, when the doctor in attendance asked genially why he had been sent to the home, he at once responded: "For shovin' another chap into the cut." On his timorous little soul the menaces of his London neighbors seem to have stamped a mild obsessional anxiety. The victim's father and friends had threatened to drown Jerry as he had drowned his tiny comrade, and were forever trying to decoy him in the direction of the canal. He now invariably inquires if there is water in the places he is going to, and seeing one day a well that supplied the local pump (for long a source of eager interest), asked tremulously: "What would happen if I fell in?" At first he refused to go to Brighton "because it was seaside," and he "would get drowned," and, wherever he is taken, he always wants to know if "they" (the relatives of his victim) will find him "down there." The obsession reappears, though with diminishing frequency, in night terrors;<sup>3</sup> when roused from bed one night at ten o'clock, he shouted—"Garn, I'll 'do' you"; and then subsided, as he wakened more thoroughly, into a meek and childish whisper: "Yes, please; I want to get out."

His affection appears in odd, impulsive outbursts. Even at his first school, which he so cordially detested, he showed the deepest devotion to his teacher; at another school his fondness

---

<sup>3</sup> It is noteworthy that these and the more troublesome forms of emotional behavior are invariably revived by a visit or a present from his London relatives.



for the mistress flared up in a burning jealousy of other children. When a walk was arranged he would ask: "It's just me and you, isn't it? No one else?" or blurt out angrily, "Wot d'yer want to let the others come for?" With his playthings, his cakes, and his sweets, he is often surprisingly liberal. And, as a rule, he is kind almost to chivalry towards whatever little girl may win his fancy at the moment. With animals he is as capricious as he is with his own companions. He will pelt the cat with stones; then cuddle it, muttering compassionately, "Poor kitty, did'ums, poor kitty." Being sent to a country house where there were no young people at all, he soon made chums with all the stray dogs in the vicinity, and now, at the age of nearly nine, he can be trusted to feed and clean the puppies and the rabbits without reminder—a praiseworthy feat for a boy of his type and years, with but the scantiest notion of personal cleanliness for himself.

Yet he loves a crowd, and it is in the midst of a knot of other little children that he becomes most violently excited. With older boys and girls who for the most part soberly ignore him, he is comparatively still, and at times he can be as submissive and suggestible as on other occasions he is headstrong and assertive. Alone with a calm but understanding adult, he proves docile, tractable, and obedient. Indeed, like a restive pony, he plainly prefers a firm hand on the rein.

Most of his feelings are but transient flutters. Yet, in his simple way, he is capable of an affection that is something more than a fleeting emotion, a primitive doglike sentiment for an individual person, a regard and an attachment that will for a while endure. And, quite recently, he has approached the level of abstract hero-worship. At the moment, he is the fervent worshiper of one who to him can be little more than a pale pictorial figure and a name—Robin Hood. Jerry now walks out with a huge bow and arrow he has made, acting in fancy the part of the outlaw. He has given a precious shilling to a tattered organ grinder "because Robin was so good to the poor," and one morning he asked: "Did Robin Hood have a cold sponge? . . . Then I will."

He is liable to moments of reckless merriment and of misery

no less abandoned. Ordinarily he is a happy little ragamuffin, especially when away from other children, free and unopposed. He has a sharp sense of humor, a ready smile, and a mischievous grin, and often becomes convulsed with seemingly causeless laughter. Taken one evening to the pantomime, he entered noisily into the fun of the piece, beating time with the conductor, and calling out, "Good old Puss in Boots!" "Shake hands, Puss." On the way home in the bus, he tried a few practical jokes of his own, pulling the bell, poking fun at the conductor, and knocking off another boy's hat, saying at once: "'Twasn't me. That little girl in front done it."

But he is equally susceptible to depression and grief. Many a time I have seen this heartless little homicide sobbing and screaming like a child of two. On the last occasion that he was brought to my office to be tested—being then nearly nine years old—he broke off, after twenty minutes' talking with my assistant, and, feeling a little tired and apprehensive, began to whine, "I want to go home." Soon he worked himself up into a hysterical tempest of tears. But in two minutes the squall was over, and with a penny in his fist he was answering as gayly as before.

Like most emotional children, he has a bright imagination. On his return from the South Coast by train, he peopled all the woods of Surrey with "little white men what rides on white 'osses." Fairies he takes earnestly to heart, and is full of half-original romances about their ways. His inventiveness is shown by the quick cunning with which he devises his impish pranks and by the untruths he fabricates to glorify himself or to elude detection and punishment.

About a year ago, in a couple of evening papers there appeared a paragraph to this effect: "A little boy named Jerry Jones was found by a railway guard asleep in an empty train at Brighton. He told the police that his mother had beaten him and that he had traveled that day from King's Cross, escaping observation by hiding under the seat." As a matter of fact, Jerry was then staying at Brighton with a foster mother; he had soiled his bed, and in dread of a thrashing, had run off and hidden in a railway carriage not many yards from his home.

His story, which was garnished with much petty detail, was nothing but a circumstantial lie.

### Definition of the Unstable and the Temperamentally Defective

Here, then, compiled from a long study and condensed from numerous reports, is a concrete picture of the inconsistent type of temperament which so many young delinquents display. "*Nil unquam sic impar sibi*,"<sup>4</sup> might be their motto: "Everything by starts and nothing long." Affection and anger, assertiveness and fear, curiosity and disgust, submissiveness and sex—all the human emotions and all the animal instincts are inherited by them to a degree unusually intense, and remain, throughout their earlier years, almost wholly unsubdued by loftier purposes or interests. First one impulse, then another, then a third, each contradictory to the last and each successively excited by the changing situations of the moment, explodes forthwith into action. And the life of the unstable child becomes a series of discontinuous fulminations, like the pops of a Chinese cracker.

All children, just because they are children and not mature adults, have minds more or less unbalanced. The difference between different individuals is but a difference of degree. Once again, some clear criterion must be laid down, some line of demarcation traced, to distinguish what is normal from what is not. For administrative needs, rough limits, analogous to those employed in cases of intellectual subnormality, seem equally appropriate here. I suggest the following. In accordance with the proposal put forward elsewhere,<sup>5</sup> the most extreme examples—

---

<sup>4</sup> Horace, *Satires*, III, i, 18-19. The paraphrase is Dryden's.

<sup>5</sup> "Delinquency and Mental Defect," *Brit. Journ. Psychol.* III (1923), iii, pp. 168-78. In this article I have urged that the conception of temperamental deficiency should be substituted for that of moral imbecility. As regards diagnosis, the essential points are, first, that not one instinct or emotion only, but all, or at least the majority, should be excessive, and, secondly, that the excess should be attributable to an inborn and therefore a permanent condition. Cases of mere psychoneurosis and of mere adolescent instability are thus ruled out. Jerry

the 1½ per cent who of the whole population are most emotional—I regard as “temperamentally defective,” and the next most emotional 10 per cent as “temperamentally unstable,” using these phrases in a restricted and technical sense, and taking the percentages as no more than round approximations. The temperamentally defective I should define as persons who, without being intellectually defective, exhibit from birth or from an early age a permanent emotional instability, so pronounced that they require care, supervision, and control for their own protection or for the protection of others. Broadly speaking, if we endeavor to make an age scale for temperamental development, parallel to the age scales measuring the growth of intelligence, the temperamentally defective child is one who shows less emotional control than would be manifested by an average child of half his chronological age; and the temperamentally defective adult, one who shows less emotional control than an average child of seven.

With this criterion, about 9 per cent of my delinquent cases would be classifiable as temperamentally defective, and 34 per cent as temperamentally unstable. In addition, there is a small but important group of cases in which the child's emotionality—demonstrably intense from infancy onwards—only rises to the pitch of excess about the time of puberty: these form the difficult yet hopeful cases of adolescent instability. They constitute 2 per cent of the total group of delinquents, no insignificant proportion when it is remembered that three-fifths of the total group were still below the school-leaving age. If all three groups be added to make one, it will be seen that nearly half the juvenile offenders are distinguished by a profound and widespread instability of the emotions (Table XVIII). Thus, *among all the innate psychological characteristics of the delinquent, a marked emotionality is one of the most frequent, as it is one of the most influential.*

---

marks the borderline. Were his behavior not in part the result of a neurotic complex, he would be definitely below it. As it is, while the element of hysteria persists uncured, he still remains indubitably a case for an institution.

TABLE XVIII.—PSYCHOLOGICAL CONDITIONS, EMOTIONAL, INBORN:  
GENERAL EMOTIONAL INSTABILITY

	DELINQUENT					NON-DELINQUENT		
	Boys		Girls		Average	Boys	Girls	Average
	Major Factor	Minor Factor	Major Factor	Minor Factor				
Temperamental deficiency.....	6.5	3.3	8.1	1.4	9.6	0.5	1.5	1.0
Temperamental instability.....	4.9	27.7	5.4	31.1	34.0	8.5	10.0	9.2
Adolescent instability.....	1.6		2.7		2.0			
Markedly repressed type <sup>1</sup> .....	[1.6]	[13.0]	[5.4]	[21.6]	[19.3]	[4.0]	[8.5]	[6.2]
Markedly unrepressed type <sup>1</sup> ...	[4.1]	[3.3]	[6.8]	[5.4]	[9.1]	[5.5]	[4.5]	[5.0]
Emotional apathy..		3.3		1.4	2.5	1.0	2.0	1.5
Total.....	13.0	34.3	16.2	33.9	48.1	10.0	13.5	11.7

<sup>1</sup> These two groups belong to one or other of the three foregoing headings and the figures for them are therefore not included in the totals.

### Group Factors in the Emotions

As in the analysis of the child's intellectual disposition, so in the analysis of the emotional, it is possible to discern not only one general or central factor affecting every inherent tendency, but also certain group factors, less generalized and more specific, limited to particular tendencies that share some quality in common. On the one hand, what we have termed the active or "sthenic" emotions—anger, assertiveness, curiosity, joy, and perhaps sex—appear specifically connected to form one correlated group, and, on the other, the passive or "asthenic" emotions—fear, submissiveness, tenderness, and sorrow—seem specifically connected to form a second, being related to each other positively but to the active or sthenic emotions negatively.<sup>6</sup>

<sup>6</sup> The distinction is based on statistical evidence, namely, the application of the so-called method of partial correlation to measurements of emotional tendencies in much the same way as it has been applied to measurements of intellectual capacities assessed by mental and scholastic tests. For a brief description of the data and the conclusion drawn, I may again refer to my two papers read before the British Association, *Annual Report*, Manchester, 1915, "General and Specific Factors Underlying the Primary Emotions," and *Annual Report*, Liverpool, 1923, "The Mental Differences between Individuals."



We may thus, among the emotionally unstable, distinguish two contrasted types—the more passive or sensitive and the more active or aggressive. In the sensitive type, owing to the operation of such inhibitive emotions as fear, disgust, and submissiveness, the more aggressive emotions are restrained or repressed. In the active type, there is little restraint or repression and the child is openly demonstrative and excitable.<sup>7</sup> In my own list of juvenile cases, I find 9 per cent to be of the aggressive and unrepressed type, and as many as 19 per cent of the sensitive and repressed. Among older delinquents, the proportions appear to be reversed—the repressed becoming in later years neurotic rather than delinquent.

### Treatment

Most of the principles suggested above<sup>8</sup> for dealing with the over-development of single instincts, may be safely reapplied to cases where nearly every instinct is running to excess. There are, however, several grave problems that are added when the child's emotional nature breaks out in all directions. The hypothesis of "general emotionality" goes far to explain a special and perturbing feature characteristic of most delinquents of this class. No sooner is one form of misconduct suppressed than another springs up in its place. A child, having successfully mastered his bad temper, will presently take to wandering; cure him of his wandering and he begins to steal; break him of his stealing, and a year or two afterwards he (or, it may be, she) reappears as a sex delinquent. There is, as it were, at the central well head of the mind a fixed and irreducible pressure of emotional force, which, directly one outlet for its discharge is stopped, is obliged to find another. Since the out-

---

<sup>7</sup> In various forms the same dichotomy appears in numerous writers, who use such terms as "subjective" and "objective" (Binet), "introvert" and "extrovert" (Jung), "herbivorous" and "carnivorous" (Bryant), "tender" and "tough" (James). It will be seen that this twofold classification of temperaments is a simplified version of the traditional four-fold classification that originated with Galen (A.D. 130), and appears, as Galen himself suggested, and as the phrases "herbivorous" and "carnivorous" or "melancholic" and "choleric" imply, to be related to differences of internal metabolism and secretion.

<sup>8</sup> See Chapter XI, concluding sections.

let need not necessarily be an antisocial one, a useful precept of reform is indicated. Arouse an interest or an emotion of a less ignoble kind, and this may attract to itself and drain harmlessly away the exuberance of animal spirits that was formerly flowing over in crime.

Throughout, it is essential that the unstable criminal should be treated primarily for his instability, rather than for his crime. This is the first and foremost maxim of procedure. In almost every instance, the criminal tendency will prove to be but one of the symptoms, though perhaps the most flagrant symptom, of the deeper emotional disturbance. What specific measures are most appropriate to the unstable child, I have endeavored to describe at length elsewhere.<sup>9</sup> Here I need only recapitulate the more general lines of approach, pointing out, as I pass, their special application to the juvenile offender.

### 1. *Permanent Segregation of the Temperamentally Defective*

For the temperamentally defective there is, or should be, no other measure but one—permanent segregation from the rest of the community. As the law now stands, this can only be enforced by certifying them either as “moral imbeciles” or as “feeble-minded” in the broad generic sense of that comprehensive term. But, as I have already argued in an early chapter of this book,<sup>10</sup> the defining clauses of the Act need careful revision to render them more conveniently applicable to defective delinquents. To term a temperamental defect a “moral one,” to throw in the misleading word “imbecility,” to make irresponsiveness to punishment the prime criterion is as misleading as it is unjust. On the other hand, so long as a clause exists that is evidently intended to cover cases of moral disorder, many magistrates and certifying officers will be disinclined to stretch the other clauses so as to include the temperamentally defective under the same category as the intellectually defective.

Both in this country and in America one or two experimental institutions have been established to deal with the problem of

---

<sup>9</sup> *Child Study*, *loc. cit. sup.* and *School Hygiene*, vii (1916), pp. 1-14.

<sup>10</sup> See pages 29 *et seq.*

the unstable delinquent.<sup>11</sup> Obviously, the herding together of a crowd of excitable offenders within the walls of a single building must be fraught with numerous risks, and owing to the various troubles arising, many of these places have been closed almost as soon as they have been opened. Nevertheless, whatever be the disadvantages both to the sequestered individuals and to those who have charge of them, institutions of this kind are indispensable, if only in the interest of society at large. With further experience and improved facilities, ways will undoubtedly be found to meet the special problems springing up behind their doors.

Meanwhile, it should be noted that a diagnosis of temperamental deficiency is to be made only in the rare and sure instances alluded to above. The frequent plea that every person whose temperament seems unbalanced should be confined forthwith, can carry no weight. And, since transitory cases of a commoner type—particularly those of adolescent instability and remediable psycho-neurosis—may easily be mistaken for those of temperamental deficiency, the child, wherever a doubt exists, should reap the benefit.

## 2. *Temporary Removal of the Unstable*

Permanently to confine the milder cases would be neither just nor practicable. Nevertheless, it is often wise to remove them, for a time at least, from home. Parents and brothers and sisters may be of the same excitable nature as the particular child in question, and the reciprocal reaction between the unstable offender and his unstable family is a fruitful cause of aggravated harm. For the same reason, the unstable child should never remain in the charge of an emotional or neurotic teacher. And, generally speaking, all who are highly strung,

---

<sup>11</sup> One of the most detailed accounts of such an experiment is that given by Dr. Edith Spaulding in her book, *An Experimental Study of Psychopathic Women* (Publications of Bureau of Social Hygiene, New York, 1923). I have commented in a previous chapter upon the institutions established for unstable defectives in this country. A special reformatory or prison is also needed for offenders of the unstable type who are not necessarily defective in the ordinary sense.

unless under institutional care, should be kept apart from one another. Of the younger children, some show their excitability most of all when other young children are present; they do best if sent to some quiet adult household where there are no small inmates except themselves. For many of the older cases, the influence of normal boys and girls of their own age or perhaps a little beyond it has a steadying rather than a provocative influence. Often, so soon as they are transferred to a school or residential home where the tone is tranquil and the atmosphere contented and composed, they slip at once into the established routine. Group work tends to drown individual flightiness in a collective attention and collective regularity. Good form forbids excessive demonstrations. The public opinion of their fellows takes the place of the arbitrary dictates of adult despotism and is far more effective in lessening breaches of discipline.

### 3. *Country Life*

By choice these impressionable young people seek surroundings full of strong, diversified, and personal stimuli. They are born inhabitants of Vanity Fair. In the life of the city and its streets, with its ever-changing sights and sounds, its eventful whirl and motion, its rich variety of people and crowds, its spectacular shop windows and endless amusements—there is the favored haunt of the lover of excitement; there he can be giddy all day long. No environment could be more unsuitable. If he is to gain and preserve his balance, a level life, a steady stage, a quiet background for his everyday existence are essential. The most stable surroundings, both physical and social, are the best for the unstable child. Intense, sudden, and desultory distractions should be avoided or withdrawn. A pastoral life, with its relative uniformity and monotony, its orderly procession of seasons, its natural and impersonal interests, makes an excellent school of repose. For milder cases a permanent change may be too costly. But, even for them, a short holiday in the woods or fields, where they can run wild for a time, without too much personal contact or restraint, will often have a valuable cathartic effect, and if they can be kept in

the country until the first new thrill has worn away, they may come back to town more subdued and better controlled.

To all this, however, there are at times exceptions. The repressed, the nervous, and the sensitive often stand the country badly: it bores and irritates them. "The same old tree in the same old place, every hour of the day, every day of the year" is a thing to gall them past endurance. Those who are introverted sink back into their daydreams, and sometimes the more exhilarating stimuli of the streets grace rather than demoralize them.

#### 4. *Discipline*

*Repressed Types.*—For the sensitive and repressed, the ideal discipline is no discipline at all. What I have urged for all delinquents is especially true for this particular group: the best form of control is the control that is exercised by the child himself. Time after time, as we have seen, the real precipitating cause of trouble has been the injudicious efforts made to rule the child by threats and penalties imposed from outside. Such efforts lead, as we shall presently perceive, only to further repression, and to repress a child of such a type is simply to prepare the ground for some neurotic growth or else its criminal equivalent. All forms of intimidation should be dropped. Never use menaces or feints. Never threaten the dire things that happen to wicked children in this world or the next. Never seek to harden the sensitive child by exposing him to ridicule or condemnation or by "knocking the nervousness out of him." When reprimand or punishment is necessary, it is best conveyed by a little silent ostracism. The shy, sly, reserved young rebel, however unsociable upon the surface, in his heart is pining for sympathy, and dislikes to feel he is alone.

*Unrepressed Types.*—With the unrepressed, the problem of discipline is more perplexing still. Often, by a strange perversity of human nature, their unrestrained aggressiveness is itself a reaction against restraint, and no sooner is the restraint lifted boldly away than their aggressive behavior ceases.



For younger children the best place is a school or nursery organized upon Montessori principles. With older children the liberty of a "free-discipline" class or a "free-discipline" colony may seem an enterprise more hazardous; but, after an initial period of license, freedom is followed nearly always by success. In the ordinary home such methods may be impracticable. At times, indeed, it becomes a question whose health and nerves are to be sacrificed—the child's or the mother's. There are few households and not many schools in which every external regulation can be dispensed with. Nevertheless, without any semblance of unjust favoritism or exceptional leniency, the burden for the irrepressible child should be made as light as it can be, and, if necessary, his fellow pupils may be told that special allowances are being made for him because he is, in effect, unwell. As a general principle, rules, taboos, injunctions, and efforts at compulsion of whatever kind should be reduced to a minimum. If indeed a thing is ordered or forbidden, then obedience must be firmly enforced. Never enjoin anything that is likely to be disobeyed. And generally, if a thing must not be done, it is far better to give the child no chance for doing it than to tell him it is not allowed.<sup>12</sup> Guide him, therefore, not by authority or by rules, but by his own discovery of what is possible and what is not. Coercion, when coercion is imperative, should be as impersonal and unemotional as possible. If any emotion must arise, rather let it be that of good-humor and laughter, not that of anger, tears, or reproach.

Conflict is at all times to be avoided. The ideal medium for such inflammable souls would be a perfectly frictionless fluid. Collisions, whether from within or from without—whether arising between the child himself and those in authority over him or between the child's own conscientious scruples and the impulses of his deeper instincts—should, so far as practicable, be foreseen and adroitly evaded. Too often the sole problem

---

<sup>12</sup> The maxim is Rousseau's: *Ne lui défendez pas; empêchez-le* (*Émile*, 1762, II, p. 77). He adds: "So long as children find resistance not in human wills but only in things, they will never become rebellious or choleric"—or, as modern psychology might prefer to say, they will never develop an "anti-authority complex."

which the teacher or parent considers is how to manage an emotional scene once it has started; the real secret is to obviate such scenes altogether. Should the child commit some serious misdemeanor, do not put yourself in the wrong by exaggerating it. Say nothing. If he is politely "cut," or "sent to Coventry," or "given the cold shoulder," he will gradually discover, by himself and for himself, where his action has been wrong; and this self-made inference will be far more convincing to him than any amount of parental reiteration. Talk to the child and at the child as little as possible. When restless, noisy, inattentive, or disobedient, he should not be treated as "naughty," but rather as "ill." When he is excited, angry, or crying, do not upbraid or reason with him, much less try to lecture him or shame him publicly before an audience. With kindly tenderness and solemn pity, lead him away from other persons and leave him to himself. If he is little, put him to bed, avoiding all appearance of correction: his face and hands may be cooled with water, or he may first be given a warm bath. If he is older, he may be sent out alone into the open air, to recover his composure in solitary proximity to Mother Nature.

With all, the safest discipline will be the discipline of experience, and the most effective penalty for wrongdoing, the natural consequence of the act. In this, at least, both Rousseau and Spencer were sound psychologists. "*Il ne faut jamais infliger aux enfants,*" says Rousseau "*le châtement comme châtement; il doit toujours leur arriver comme une suite naturelle de leur mauvaise action.*"<sup>13</sup> "Satisfy yourself," says Spencer, "with leaving your child to suffer the inevitable effects of his action, and you will avoid both hot-house virtue and demoralized antagonism."<sup>14</sup> Thus, as virtue should be its own reward, so vice should be left to bring its own punishment: for everywhere, the ultimate aim must be to produce a self-governing creature, not a creature who needs always to be governed by others.

---

<sup>13</sup> *Emile*, II, p. 90.

<sup>14</sup> *Education: Intellectual, Moral, and Physical*, Chap. iii, p. 165. The teacher will find an admirable account of modern ideas on discipline in Dr. Ballard's recent book on *The Changing School* (1925).

### 5. *Physical Exercise and Recreation*

Games, athletics, and physical exercise in every form should be utilized to supply a vent or yield a substitute for crude emotional reactions. Sport may be a form of self-indulgence, but it is a form of self-indulgence that teaches self-denial. There is not one instinct but has been made the basis of some civilized mode of recreation—pugnacity, of such games as football; hunting, of the chase; sex, of dancing; the herd instinct, of team games; the self-assertive instinct, of games demanding leadership. The natural craving for play, for fun, for recreative excitement, should thus be gratified by all available and lawful channels. So far as possible, each instinct should be indulged in its most natural as well as its most salutary form. Even for the urban child, free access to nature should be provided by expeditions, summer camps, school gardens, field work in botany and natural history, and the like. And, once again, outdoor life in the country will best afford the various instincts and emotions their needed exercise through impersonal rather than personal stimuli; it furnishes those natural situations which in primitive life not only provoke, but also work off, use up, and even regulate, the hereditary activities of mankind. Energy may thus be diverted into avenues which will be devoid of harm and perhaps productive of good, and there will be no superfluous force left behind to spend itself on coarse antisocial behavior.

Like many defective and subnormal children, the unstable are, as a rule, especially susceptible to music. If motor activity can be added, as in dancing and instrumental music, they will often exhibit great talent, and make rapid headway. There was a day when no industrial school was without its brass band. So eagerly did the officious youngster take to the cornet or trombone, that the practices became the dominating feature of the place; workshop and schoolroom, meals and recreation sank to a secondary level.<sup>15</sup> Even to this hour, other forms of instrumental music are rare, and training through musical appreciation is almost non-existent. In the ordinary schools, music,

---

<sup>15</sup> See the criticisms in the *Home Office Report*, 1924, p. 30.

in the wider sense, is now taking a place so important and so fruitful that it is much to be regretted that so little use is made of it in training the emotional and unstable. Melody and harmony are in many ways the essence of synthesis, of order. They at once arouse emotion, provide it with an outlet, and keep it subordinate to a rhythmical control. Dancing, musical entertainments, dramatic plays, and simple social parties are activities that never fail to interest these young people, when all else palls; they aid in socializing their instincts and in encouraging courtesy and coöperative work. And nearly every form of artistic and æsthetic expression—especially self-expression—helps to relieve or purge the pent-up sources of excitement.

#### 6. *The Formation of Wholesome Habits*

The best thing, however, to do with strong instincts and emotions is to organize them into firm habits and fixed sentiments. This will impart a regularity of life which the excitable are otherwise bound to lack. Ideas and memories of past experience, the recall of previous injunctions given in the form of abstract principles of virtue and hackneyed rules of behavior—these, for children who are abnormal, have little meaning and less force. Even if recollected at the proper time, they are impotent in competing with the explosive power of the sudden emotional reaction which the present situation may evoke. Hence, habits, mechanical and irresistible, must be implanted, lessening the constant need for voluntary attention and strenuous self-control and leading their possessor automatically to do the right thing in the right way whenever the right moment arrives. Emotion will thus be side-tracked, and feeling eased and intellectualized. At the same time, through history, biography, and fiction, through self-expression and kindly criticism, through freedom and responsibility gradually increased, through association with cultured companions both young and old, ideals of an even life and a harmonious character may step by step be formed. Above all, treatment should start from the earliest possible moment, and must be kept throughout in the hands of calm, sympathetic, happy, understanding persons. What has been said of the emotion of love applies equally to every other :

*"celui qui est guéri le premier est toujours le mieux guéri."*<sup>16</sup>

To wait until a bad habit of emotionalism has been set up, until family friction has roughened it and adolescence has heated it beyond all bearing, is to wait until too late. The training of the unbalanced should begin in the nursery and should be continued all through school life and far beyond. Only thus can the curse of Reuben be escaped: "Unstable as water, thou shalt not excel."

### The Unemotional

From time to time a young offender is encountered who seems to suffer not, like the majority, from an excess of emotionality, but from a deficiency. His temperament is apathetic or phlegmatic, and his manner indifferent, insensitive, and inert. He is stolidly obtuse to the opinions and feelings of those around him, and in all his ways shows a lack of interest and a want of response.

Such a disposition is commoner among the dull and the defective than among the intellectually sound. Adopting the line of demarcation indicated above (namely, that a definitely abnormal case is one deviating in a normal characteristic above or below the normal level by the same degree as the top or bottom 1½ per cent of the ordinary population), and including only cases where the lack of emotion seems primary, and not consequent on other abnormalities of body or of mind, I calculate that only 2.5 per cent of my cases owe their delinquency to feebleness of general emotionality. Most of them were older boys who had drifted into difficulties either at school or at work from what may fairly be called constitutional laziness.

### Treatment

In treating the apparently apathetic, the first step is to explore the likelihood of some underlying cause. Often the child's emotions are not deficient, but merely repressed: his superficial torpor is no more than a deceptive mask—the product of in-

---

<sup>16</sup> He who is cured at the earliest age is cured the most completely" (La Rochefoucauld, *Réflexions Morales*, CDXVII).



hibitions, of a habit of daydreaming, of neurasthenic fatigue, or of a morbid negativism of a psychopathic type. At times some physical defect lies at the root of the trouble—some mild condition of general ill health or some glandular disturbance, like the athyroidism of the cretinous imbecile. Those who are also dull intellectually or intellectually defective will have been already detected by intelligence tests, and should be treated along the lines laid down above.

Unless confirmed by habit, the delinquencies of the apathetic are rarely of a grave or difficult order: to common-sense treatment under due supervision and a bracing discipline they yield easily. As a rule, not every instinct is equally deficient, and a sympathetic study may disclose, in at least one particular direction, some glimmer of talent, some gleam of interest bright enough and warm enough to give promise of a better response to more specialized appeals. For the rest, comparatively little can be done with them by way of constructive effort. We must rest content with forming firm and steady habits, making honesty the path of least resistance, and dishonesty a feat that would need a more vigorous exertion than the child is likely to put forth.

## HABIT FORMATION

### General Principles

In man, the primitive instincts at their first emergence have little of that fixed and inevitable fatality that stamps the inherited actions of the lower animals; else we should be, every one of us, irreclaimable criminals, condemned to the gallows from the cradle. Had all our powers been developed and perfected in the womb, as they might have been, had man only to burst forth into the world to find himself a finished machine, of full-grown size and with his equipment all completed, nothing in his nature could ever have been changed, whether for better or for worse. The wasp, the reptile, and the butterfly are limited to a tiny repertory of mechanical acts, with which they are born and with which they die. With man it is different. Human instincts are pliant and uncertain tendencies—seeds that may never spring up, cuttings that may never take root,

unless planted in a suitable soil and watered unceasingly by fitting stimuli. They are tendencies which, once they have pushed through, may still be twisted this way or that, like a green and flexible shoot beneath the hand of the trainer. Opportunity and exercise are indispensable to their growth. Modification, therefore, is always possible. And with any particular child, the working of his specific instincts may become permanently stereotyped in its original form, or else qualified and extended, by the general laws of habit.

### 1. *Fixation*

The continued and successful repetition of a mischievous act inevitably strengthens the corresponding tendency, so that, in the end, the same action, upon the slenderest pretext and the slightest provocation, automatically renews itself, even where the best efforts of the delinquent are opposed to it, even where its results can no longer achieve success and no longer yield satisfaction. The principle at work should be carefully grasped. What is it that thus converts a transient impulse into an established custom? It is the past success, rather than the mere continued repetition. One successful effort may make a habit: a hundred repeated failures may leave none. What counts is thus the pleasurable triumph, which, from the first, has attended the instinctive reaction. Accompanying pleasure hammers an inclination home; accompanying pain tramples it out. If there are no occasions for an instinctive misdeed, or if, whenever the occasions for the misdeed occur, it is infallibly detected and so from the outset brings not pleasure and gratification, but immediate pain<sup>17</sup> and discomfort (be it only the discomfort of failure), then the instinct is likely to wither and die: it lapses and loses all its force, either through disuse or through unsuccessful usage. If, on the other hand, the instinctive action prospers the very first time and is consummated in en-

---

<sup>17</sup> Here, of course, lies one of the chief psychological sanctions for punishment. The other—more widely recognized, but less effective in practice—depends on the memory of past pain to evoke the instinct of fear. But, with the young and the unstable, an instinct aroused by a past memory alone is a poor motive, and the calculation of consequences—pleasant and unpleasant—is seldom to be relied upon.

joyment whether unexpected or consciously sought, then an almost invincible tendency is set up for the same action to renew itself whenever the same situation recurs. The hardened malefactor is the slave of routine. He keeps to his well-worn rut and runs in his well-cut groove. It is upon this curious conservatism of the criminal mind that so much of the success of modern police detection is founded. "What he has done before, he will do again" is an axiom with most officers of experience. Old offenders return to the old scenes and revive the old associations. Most thieves steal much the same articles, at much the same time and in much the same manner, from much the same places or persons. Habit formation is always the crux, alike in the making and in the unmaking of the youthful misdemeanant. Even after the original instigating cause has been removed—the physical trouble cured or the bad companionship broken off—the old delinquencies may still continue by sheer inertia of custom. And what has wittily been remarked of affairs of gallantry holds also in affairs of crime: "It might be easy to find a person who has never known a lapse, but it would be hard to find a person who has known only one."<sup>18</sup>

## 2. *Modification*

Sometimes, however, the inherited instinct is refashioned before it is fixed. The conative impulse, the emotional energy or urge behind the instinctive action, is so inexhaustibly vigorous that if at first one selfish method fails, another and then another is persistently attempted—failure or obstruction seeming to intensify rather than to quench the driving effort—until by trying, trying, and trying again, some line is hit upon that leads at last to success. The instinct is thus to be conceived as a *vis a tergo*, a power pushing wildly in the dark towards a vaguely wanted end. So long as this end is not attained, the pent-up emotional craving leaves its possessor in a state of restless tension; and impels him to keep varying, to keep experimenting with, alternative modes of possible gratification. The more intelligent the delinquent and the more forcible the

---

<sup>18</sup> La Rochefoucauld, *Réflexions Morales*, LXXII.

emotional momentum, the wider and the more ingenious is the range of diversified expedients. The variations themselves, however, are, in the younger child as in the higher animal, struck out more or less at random. There is little or no deliberate designing. The apparent shift of tactics is not consciously schemed. It is simply the blind thrust of a strong head of water trying to stream downhill—over one obstacle, round another, out through yonder opening—until at length relief and rest are reached. The final success, the attained satisfaction, then fix the new course of conduct, in place of the crude and fruitless movement originally inherited. A fresh channel has been cut; a fresh habit has been formed. The learning of acquired activities is thus a slow and roundabout process. And in this there lies a great and precious opportunity for the alert reformer, who, during the protracted phase, may step in and by his own vigilance and skill forestall the triumph of the more likely and more dexterous maneuvers.

By the twin processes of habit, then—by “trial and error” and by the fixing agency of pleasure and success—new and more complicated ways of behaving are achieved, elaborated always out of the simpler and more primitive instinctive tendencies and under pressure of their emotional excitement.

Now, an instinct, as we have seen, is essentially an impulse to respond to the reception of some specific stimulus by making some specific reaction. Hence, the original tendency may be modified either upon its receptive side or upon its reactive side. A new stimulus may acquire the provocative power of the old one; a new form of behavior may supplant the original. And, in either case, these fresh acquirements are spun out and woven—looped on, as it were, to the central and persisting mesh of primary emotions—by the well-known process of association. Association and its fundamental laws are thus a clue to much in the delinquent’s life that seems odd and anomalous.

(a) *Modification of Reactions.*—At the beginning, the reactive side of most instincts comprises, as we have noted, crude elementary movements—crying, striking, running away, snatching, swallowing, cuddling, and so forth. For the wants of the older and more intelligent child these inborn reactions of the

baby are inadequate, and the growing infant quickly learns to substitute newer modes of conduct more subtle in character and more complex in form. The new impulse is linked on to the old stimulus by a specific mental connection—a connection which may be pictured as a fresh association path opened up within the brain: the old semi-reflex path fades away, and the old response drops out.

One important direction taken by these acquired modifications lies, as we have seen, in the use of the peculiarly human faculty of speech, in place of clumsy inherited actions with legs and arms and fingers. The child's anger comes to wreak itself rather by the utterance of abuse or of profanity instead of by primitive kicking and biting; his sex instinct may issue, not in the original physiological reactions, but in lewd chatter or salacious anecdote. A second type of modification consists in the use, or misuse, of the appliances and tools of civilization. The wanderer may travel by tram instead of on foot; the jealous child may write abusive letters with pen and ink; the over-sexed child may pencil improper pictures or chalk up vulgar words; the quarrelsome youth finds a knife or a revolver a more effective weapon than teeth and fists and nails; the greedy boy who began by grabbing tarts and sweets, learns that money affords a method, safer and surer though more circuitous, for gratifying the same original desires.

(b) *Modification of Stimuli*.—On the receptive side, the stimuli which, in the beginning, were alone able to excite the instinct or emotion, are similarly supplanted or multiplied. As before, the change and the extension are the effects of mental association. Association, however, here works in ways that are somewhat more direct. It follows, as traditional psychology has recognized, two main principles or laws—association by contiguity and association by similarity. In the former case, the connection is accidental and illogical, a matter of mere time and place. In the latter case, the connection is one of resemblance—a resemblance sometimes consciously observed, though often superficial and extraneous. A youth, for example, under the spell of the sex instinct, may desire the presence of some particular girl. The girl herself, through the



course of circumstances, may be placed beyond his reach. His emotion will then find a species of vicarious excitement in gazing, not upon her bodily presence, but at a photograph which externally resembles her, or at some garment, flower, or other souvenir which has been in chance contact with her person. For the possession of such stimulating keepsakes, theft and even violence may be employed. Rationally and objectively considered, articles of either sort are equally useless for the physical satisfaction of the instinct. Nevertheless, through association—an association due to visible similarity, in the one instance, and to accidental contiguity, in the other—the proxy acquires almost the same psychological potency as the beloved original, when present in the flesh. It prompts the same thoughts; it stirs the same emotions; it kindles and inflames the same sentimental fancies. In short, by virtue of a suggestiveness that is purely personal, it is now, for the lover in question, invested with all the meaning, with all the profound significance, of an actual sight or touch of the absent inamorata to whom it is mentally related. Such associated substitutes may, with no straining of the terms, be called the sign or symbol of the primary stimulus.

Much crime and much delinquency are symbolic in this sense. Martin, who fails in Latin and Greek, steals the spectacles of his more successful school fellows.<sup>19</sup> Nellie, who has no taste for jewelry, appropriates a locket and a ring, neither of which she publicly wears.<sup>20</sup> Harold, who would like to read but cannot, steals a number of dull, unillustrated books. George, who once wanted to take up engineering (for which he was wholly unfit) and has become a messenger boy (work to which his moderate talents are more suited), collects odd pieces of machinery which do not belong to him and for which he can find no use—the chain of a bicycle, the receiver of a booth telephone, and innumerable small spare parts of motor cars. To the dispassionate onlooker, such thefts must seem, on a first hasty glance, devoid altogether of motive. But, reading deeply in the thief's past history, tracing point by point the

---

<sup>19</sup> See Chapter IV, p. 173.

<sup>20</sup> See Chapter VIII, p. 350.

lines of connection below the level of his consciousness, a skillful analyst may soon find out that the apparently unwanted articles had acquired for the child (how, and by what processes, the child himself could hardly tell) some strange, emblematic value. Nellie had many opportunities for taking rings and necklaces, more costly, more becoming to her person, and more easy to abstract without detection: all these she passed over, to pick two special trinkets which plainly shone in her eyes with some factitious glamour. The locket was a heart-shaped locket, and in her childish fantasies stood as a token of affection from the imaginary person whose heart she secretly desired to win. The ring was a wedding ring, and by taking it she conferred upon herself, in some vague irrational way, a dim foretaste of the rich gratification which an actual ceremony of marriage would have brought. Through quaint and extravagant associations of this kind, innumerable offenses, so pointless and incomprehensible on the surface, come at last to be explained.<sup>21</sup>

---

<sup>21</sup> The suggestion of symbolic theft usually arouses incredulity in the mind of the logical layman: the term seems so mystical and the explanation so far-fetched and bizarre. Symbolism, however, plays an active part in the mental processes of the most normal, and becomes immediately intelligible once it is realized that symbolization is nothing but a special and natural result of the recognized principles of association working through contiguity and resemblance. The mental processes involved in symbolic thieving are not more fantastical than those involved in the symbolisms of everyday life. We are, for example, every one of us, profoundly moved when we hear that some foreign heathen has trampled upon the Union Jack or insulted the Cross. The one is but a yard of bunting, the other two pieces of wood: yet by their pattern they represent for us our nation and our religion, and are thus, through their associations, capable of sustaining the weight of feeling and interest that properly belong to the abstract ideas they stand for.

Of all instances of symbolic crime, perhaps the clearest and the best established are those of fetishistic stealing. Every one is familiar, from the newspaper if not from first-hand observation, with cases where a youth cuts off and appropriates the hair of an unknown woman; or pockets her shoe, her handkerchief, or more intimate portions of her clothes. Here obviously the memento so purloined is wanted, not for its real objective value, but solely for its subjective, and usually erotic, suggestions. The undergraduate's raid for "trophies" is symbolic theft of a somewhat analogous kind. The very deed itself may be committed solely for its symbolic significance as an expression of defiance or revenge.

## Treatment

Too often, by the time that he is first brought forward for psychological treatment, the criminal from instinct has been transformed into the criminal from habit. In most cases bad enough or persistent enough to come under official notice, a patient inquiry will usually elicit the fact that long before the child was found out in his latest offense, he had been engaged, unperceived and unsuspected, in a successful series of similar misdeeds. His first experiments unfortunately prospered; his earliest enterprises unluckily had good luck; he escaped punishment, achieved his end, and so paved the way for a settled course of wrongdoing. Had he been caught at the very outset of his first attempts, his offense, in all likelihood, would never have been repeated. Undiscovered until the tenth occasion, he feels that the chances must still be nine to one in his favor; with more caution and deeper craft, it is his hope to play again, this time with trumps in his favor. Something of the gambler enters into his spirit, and with the gambler's unshaken optimism, his passion grows, in spite of himself, at once more dogged, more desperate, and more resistive to cure.

### 1. *Removal of Opportunities*

In the treatment of the habitual offender, therefore, the first necessity is to snap the chain of habit that has been forged. Habits may be broken by various simple means. Let us suppose that the delinquency is one of petty theft—the commonest category of all. To begin with, every opportunity for stealing should be scrupulously cut off. Money must be locked up; the exact amounts, and no more, must be handed out for messages to shops, so that change cannot be embezzled; local confectioners must be warned to sell no sweets to the child; the child's own occupations, where he is and what he is after, must be, not necessarily watched, but known to a certainty, at every

---

On the subject of fetishistic and symbolic stealing, the reader may consult Binet's early work, *Le Fétichisme dans l'Amour* (1891), Havelock Ellis's *Studies in the Psychology of Sex* (1897), Freud's *Three Contributions to Sexual Theory* (1910), and some of the cases recorded in Pfister's *Psycho-Analytic Methods* (1917, see especially p. 331).

minute of the day. If these and similar precautions are begun without ostentation and maintained without fail, then, after a period varying with the antiquity of the habit, the habit may be expected to die of inanition—to atrophy (in the biologist's phrase) through disuse.

## 2. *Rewards*

Presently, by slow degrees, the old opportunities may be allowed to reappear. But vigilance, though still unobtrusive, must now be redoubled rather than relaxed. When the child has gone for a week or a fortnight with no further slip, he may be appropriately rewarded. At first, the recompense may well take the form of those very pleasures for the sake of which the child was stealing. Thus, a child who habitually took money to buy delicacies at the candy store or a seat at the cinema, is led to discover that, so long as he refrains from stealing, he enjoys even more treats of the sort he desires than he formerly enjoyed while stealing, and that now, when he does steal, he reaps no enjoyment whatever. The forfeiture, of course, must be prompt; and immediate deprivation requires instant discovery. Too often the parents allow the child to outwit them once again, or permit themselves to forget or to shield his renewed misdemeanors, and it is not until the situation has become as intolerable as before that they report what has again extended into a long tale of growing enterprise.

But with most children, particularly in the later stages of the training, a more effective form of moral bribery is to be found in the finer pleasures of social intercourse. To learn he is on the way to sacrifice the esteem of all his fellows, whether young or old, is a sore experience for any but the most hard-hearted. The recovery of social confidence he will cordially appreciate. Introduced, at a tea party or on a holiday excursion, to new companions who find delight in his company, he will do much to gain and to keep their respect. Should there be any small backsliding later on, a return of cold indifference will restore his better feelings far more successfully than reproaches, threats, or corporal castigation.

### 3. *Penalties*

Punishment, if there is to be punishment, must be swift and certain. It must be certain, for all gambling on the risks of a possible escape must be precluded. It must be swift, for the automatically inhibitive effect of pain works, not by retrospect, but upon the mental process that it directly accompanies or immediately succeeds. Every one has smiled at the unwise owner of a wayward puppy who, when the puppy tears off for a spell of mischief in the street, calls him back, and then, when at last the puppy answers the call, beats him for an act long past: the natural consequence is not to stop the puppy from racing away in future, but to make him ever afterwards hesitate to come back at the owner's summons; for the owner has unwittingly punished an action he never meant to punish, and has associated pain, not with running off, but with returning. In the same way, if punishment is postponed till the boy confesses or till father comes home, the result is to make the boy dislike his father and take great care for the future never to own to his misdeeds.

One general maxim, on psychological if not on moral grounds, I am inclined to put forward. It may seem at first a paradox; but it rests upon many varied observations. Punishment, as a rule, proves far more effective with mild impulses than with strong: as a mode of deterrence, it is like a blast of the wind which will extinguish the flickering taper but may only fan the burning coal to hotter flame.

### 4. *Graded Moral Exercises*

In most cases, however, what is chiefly needed is not some single summary measure, but a sustained, bracing, educative training. It is easier, as it is more profitable, to build up new habits slowly than to try abruptly to break down the old. Among other expedients, the following may be advocated. Its object is to train the child, little by little and step by step, through tasks of increasing responsibility. It is a method which often answers admirably in cases of juvenile theft. Every day the thief is to be practiced upon small commissions, each



taxing his honesty a little more than the last, until he can be thoroughly relied upon in whatever situation tempted him before to steal. At first, perhaps, a child of nine who knows his mother is expecting him to bring home twopence change can hardly be trusted to walk past a candy shop, though fully aware that sure detection and sharp punishment must follow his breach of faith. Let him find, therefore, that, when at length he can bring home the change entire, he will be allowed not only to spend the guarded twopence, but fifty per cent extra by way of interest and reward. When he has learnt to prefer an honest but postponed threepence to twopence stolen out of hand, reward him sometimes with twopence only, sometimes with nothing at all. After he has learnt to be faithful with twopence, test his fidelity with sixpence, of which he may spend half, but no more, during the actual errand. Later, trust him again with sixpence, but postpone the reward (duly increased, perhaps) to another day. Later yet, the temptation may be made still greater, and detection—in appearance at any rate—still less inevitable; and so onwards, with tasks and trials of augmented difficulty, until he feels he can repose full confidence in himself. Do this, not with needless messages flagrantly trumped for the purpose, but in a perfectly natural way, without the smallest hint of any bargaining, and discussing with him neither the purpose nor the result. It will become at last his special pride to discover that, when any mission of trust is wanted, he is always the one child selected out of the five hundred in the school.

With the needful changes, the principles and procedure which I have thus illustrated for habit breaking in the case of the young thief can obviously be applied to delinquencies of other forms—to long-standing truancy, chronic ill temper, and recurrent malpractices of sexual origin. The details, of course, must be ingeniously adapted to the needs of each. Never should they be purely destructive, never entirely negative. Positive methods and constructive efforts must be added to implant higher interests and loftier sentiments, along the lines I shall prescribe in the chapter that follows.

### 5. *Removal from Old Surroundings*

Where habits are long-standing and deep-rooted,<sup>2a</sup> where all ordinary methods for conquering them are plainly useless, where intelligent coöperation is forthcoming neither from the home nor from outside, there one measure alone can be advised—immediate removal, away from old associations, into an atmosphere of better watchfulness and discipline, where no chance for the recurrent offense can possibly arise. One of the chief services to be rendered by the industrial school and the reformatory is the interruption of confirmed bad habits that yield to no other means.

---

<sup>2a</sup>It is worth while noting that the strength of the habit cannot be gauged solely by the duration of the delinquency or by the number of offenses. Children display wide differences in the speed with which they can learn and unlearn. With an individual case something may be deduced from tests of learning and of habit formation. But the best criterion is an actual trial during a period of probation, under proper conditions of supervision and control.

## CHAPTER XII

### SENTIMENTS AND COMPLEXES

Search, then, the ruling passion; there alone,  
The wild are constant, and the foolish known,  
The fool consistent, and the false confest:  
This clue once found unravels all the rest.

POPE.<sup>1</sup>

*Acquired Emotional Dispositions.*—Our discussion of the laws of habit and association has led us from the inborn elements of character to the acquired. For these acquired dispositions, into which instincts and emotions, habits and ideas become progressively built up, the simplest and most intelligible name is "interest." "Interest," indeed, suggests a somewhat intellectual concern for somewhat impersonal matters, and is, therefore, not the psychologists' own term. Older English writers spoke rather of "passions," including passions for topics as well as for persons and emphasizing the emotional side rather than the intellectual. Contemporary psychology prefers, in this country, the term "sentiment," thus indicating that a personal rather than an abstract character is really distinctive of the most prevalent and most fundamental interests. More recently still, upon the Continent, psycho-analysts have introduced the word "complex"—a word, however, which, in its stricter use, is a term of psychological medicine, and denotes a system of ideas and tendencies that are in part repressed and have in consequence a pathological or morbid tinge.

By whatever name it is known—sentiment, interest, passion, or complex—each of these acquired components of character consists of an organized group of emotions, all associated with the thought of the same object. The associations themselves

---

<sup>1</sup> *Moral Essays*, Ep. iii, 11, 1-4.

are often unconscious, being produced, not by an apprehension of logical fitness or relation, but by an unapprehended or insensible linking, due to accidental contiguity in time or place, or to similarities and likenesses comparatively inessential and often unnoticed by the mind they influence. In the last analysis, sentiments, like instincts and reflexes, may be viewed as physiological mechanisms, and the associations which bind their elements together may be conceived as nerve paths within the nervous system. Unlike instincts and reflexes, however, sentiments are the separate acquirements of the individual, rather than the common legacies of the race; and the nervous circuits which go to their making are opened up by experience and by training, not handed on by inheritance at birth.

Of all the interests that growing children form, the earliest and the most universal are their sentiments for their parents. Almost every one of the child's more primitive emotions—submissiveness, tenderness, fear, anger, curiosity, and even sex—come to be variously connected with the thought or perception of its mother or father—the whole mental system thus constituting a highly excitable tissue of wishes, impulses, and feelings. Later on, the child forms interests or sentiments of a similar pattern for other persons about him—his brothers and his sisters, his comrades and his teachers, and in after life his employer, his sweetheart, and his wife. Such further interests are seldom constructed *de novo* or evolved, as it were, *in vacuo*. In general, some simple and suggestive feature in the new personality couples the thought of him, directly or indirectly, with the preformed memories or with the preëxisting mental attitude that has grown up around the old.<sup>2</sup> The turn given to the child's

---

<sup>2</sup> This transference may sometimes be a sharp and violent one. The singular phenomenon described as "love at first sight" is of this order. The child or youth has already built up a sentiment or interest for some idealized personality, modeled in its ultimate beginnings upon the person who interested him first, namely, his mother or father. Into this pre-conception—in virtue, it may be, of some entirely trivial similarity in name, in feature, in mode of speech, or in characteristic manner of behavior—the newcomer fits instantly, like a wax cameo into the intaglio from which it was cast. As a result of this connection, a stranger may receive, in full flood, the concentrated volume of transferred emotion that had originally collected about the thought of the parent. In the

personal interests during early years thus lays the foundation for his social outlook during all his future life. In setting up new attachments, we build always on the basis of the old. With these points of preference and predilection, if not with the persons themselves, *on revient toujours à son premier amour*.

Sentiments, however, are not concerned with persons only. Interests may be progressively developed for impersonal and inanimate objects, as money, toys, or school, and for ideas entirely abstract, as a hobby, a profession, or even an ideal of virtue and conduct.

Together with its correlated emotion, an instinct, we have seen, is essentially a source of mental energy. Being by definition a coördinated system of such instincts and emotions, a sentiment or interest provides an accumulated magazine of spiritual force. It is a reservoir of power. In the moral character, therefore, of all who are old enough and intelligent enough to have their mental processes systematized in this way, sentiments are by far the most potent factors. In the directing of conduct and behavior, they constitute the ruling guides and supply the main incentives. They furnish our chief aims, our chief motives, and our chief ideals, together with the vigor and enthusiasm needful for their achievement.

In the study of the individual delinquent, then, the exploration of his special interests must constitute a vital and perhaps the most essential item. We have to ask, first, what obvious sentiments he has acquired, and, secondly, what hidden complexes have taken root within his mind. In no other way can his true motives be unraveled.

---

same sudden way, unreasoning prejudices, illogical hatreds, abrupt dislikes, may be based on a first impression:

"I do not like thee, Dr. Fell,  
The reason why I cannot tell."

And thus a child who, like Nellie (page 356), has developed into a rebel at home falls at once into the same attitude of antagonism when confronted with some new authority—a teacher, an employer, or an officer of the law—whose position may for the young mutineer be reminiscent of his own stern or tyrannical parent.



## SENTIMENTS

Interests may be either positive or negative; they may be either sentiments of liking and attraction or sentiments of hatred and dislike. Both kinds may conduce to delinquency. And in doing so, the positive interests (or sentiments of attraction) may themselves act either positively or negatively—positively, by their presence and direct influence along undesirable lines, negatively, by their relative weakness or deficiency.

### 1. Sentiments of Attraction

#### *Absence of Desirable Interests*

The absence of desirable interests seems in delinquent children far more likely to be overlooked than the presence of interests that are definitely undesirable in themselves. In 3 per cent of my cases there was a complete absence of all cultural interests in children otherwise bright and intelligent, and in as many as 10 per cent an absence of affection for any relative, acquaintance, or friend.

What must be the effect upon the growing child of the absence of such sentiments? Sentiments are absorbers of superfluous energy; they keep the machinery of life in even motion, like the flywheel of an engine or the balance wheel of a clock. Without such controlling mechanisms the child must be at the caprice of each inconstant emotion that every passing stimulus happens to touch off. The mere consolidation of his miscellaneous instincts about a single harmonizing purpose is, in a measure, a guarantee of stability and steadiness. When these binding interests are broken up, the component impulses fall apart again, like the staves of a barrel when the hoop is removed. Observe how the young lover, the newly wedded wife, or most of all the young mother—no matter how wild and irresponsible her previous career—pulls herself together (as we say) for a life of sustained devotion; and, again, how on the death of the beloved object, or disillusionment about the cherished ideal, the bonds are loosened and the unhappy creature relapses or regresses to an almost animal stage: the world seems suddenly empty of aim, of meaning, even of reality; existence goes under, like a

scuttled barge, drifting back or sinking down to the confused, chaotic level of primitive impulsiveness, of a low and selfish sensuality.

The love of virtue or of a virtuous person is one of the most effective inhibitors of vice and crime. It acts both as a brake and as a bridle. The child who is held in by a sincere affection for his teacher or a loyal enthusiasm for his school is not likely to go galloping headlong into the cruder forms of temptation. The child who has no such attachments, nor other attachments to do their office, has nothing whatever behind him to rein him back when face to face with some seductive mischief. The want of such sentiments leaves the original instincts a free and unrestricted play. It is not only that the child is unoccupied and that there is mischief lying ready for his idle hand; his instincts themselves are unorganized and uncontrolled. They are neglected kegs of dynamite awaiting the first spark or match to ignite them into perilous explosions. In such a case, it is the main aim of the reforming psychologist to raise up some counteracting interest, to fasten the child's pleasurable instincts to some worthier external object, to inspire him with some genuine fondness for his family, some spirit of respect for himself, some *esprit de corps* for his school or his club, some all-consuming zeal for work, for sport, for refined and refining recreation.

#### *Presence of Undesirable Interests*

The positive influence of undesirable interests is plainly demonstrated by the figures in my table (Table XIX). Unlike the mere absence of interests, the presence of these active interests may operate as the main and even the only cause: this has been so with 6 per cent of the delinquent boys and 4 per cent of the delinquent girls. Such preferences are not of necessity undesirable in themselves: they may prove undesirable solely from their ultimate effects. Indeed, as is shown by the figures in the table, a passion for something definitely pernicious or for something intrinsically harmful, is during childhood relatively rare.

Vicious or innocent, these childish interests, when present,

may produce delinquency in either a direct or an indirect way. The most powerful, the most directly operative, are sentiments for persons. Regularly at certain ages children become hero worshipers; and the idol selected may be one who sets a dangerous example to the undiscerning votary. With the girl, some glittering cinema star, with the boy, some sprightly comedian or dashing adventurer, too often furnish the ideal which dazzles their young, infatuated fancy. Sometimes an older associate, of reckless habits and unscrupulous morals, may offer the mold on which the aspiring disciple shapes his conduct, the model he strives to live up to.

But these debasing enthusiasms are by no means of an exclusively personal type. An exciting emotion itself may become the subject of an emotionally exciting sentiment, and its thrills may be sought after for their own sake:

*Aimer est le grand point; qu'importe la maîtresse?  
Qu'importe le flacon pourvu qu'on ait l'ivresse? <sup>3</sup>*

Any primitive stimulus that has the natural property of awakening some one particular instinct readily develops into a focus of systematic interest, directly demoralizing in its effect upon action. A child may acquire a passion for expensive edibles—sweets, tarts, and similar delicacies, the mere sight of which he is unable to resist. An older youth may perhaps develop a fondness for drink in some intoxicating form. Sexual things grow easily into permanent topics of attraction, and thus become capable, not only of arousing the inborn sex instinct which constitutes the original response to them, but also of provoking other instincts—curiosity, mild and pleasurable disgust, the cruel or violent aspect of the instinct of assertiveness, the self-martyring element in fear and self-submissiveness; so that, while the healthy boy or girl makes a master passion of some wholesome game or sport, the pervert's supreme pre-occupation becomes the study of sex in all its manifold emo-

---

<sup>3</sup> "To love is the main end; what matters it who the loved one is? Or what vessel is used, if only the intoxication is achieved?" (Alfred de Musset, *Nuit de Mai*).

TABLE XIX.—PSYCHOLOGICAL CONDITIONS, EMOTIONAL, ACQUIRED: SENTIMENTS, INTERESTS, AND HABITS

	DELINQUENT				Average	NON-DELINQUENT		
	Boys		Girls			Boys	Girls	Average
	Major Factor	Minor Factor	Major Factor	Minor Factor				
Obsessive imagery...		1.6		2.7	2.0			
Obsessive habits....		6.5		4.1	5.6			
Passion for the cinema	0.8	6.5		1.4	5.1	3.5	1.7	
Sweets.....		3.3	1.4	5.4	4.6	2.0	5.5	
Money.....	2.4	1.6		1.4	3.0	1.0	0.5	
Clothes.....				6.8	2.5		3.5	
Adventure.....	3.3	15.4	1.4	2.7	13.2	5.0	2.5	
Various forms of pleasure and amusement <sup>1</sup> ....		4.1	1.4	4.1	4.6	0.5	1.0	
A particular person of the opposite sex <sup>2</sup> .....		2.4		1.4	2.0	4.5	6.5	
Open hatred for a particular person..	0.8				0.5			
Lack of affection for relatives or friends		12.2		6.8	10.1	1.5		
Lack of cultural interests <sup>3</sup> .....		3.3		1.4	2.5		0.7	
Total.....	7.3	56.9	4.2	38.2	55.7	18.0	16.5	
						17.2		

<sup>1</sup> With boys—amusement parks, traveling in trams, toys, sport, theatres, gambling, etc. With girls—restaurants, theatres.

<sup>2</sup> Healthy attachments and petty love affairs having no relation to delinquency are not included in the figures for delinquents: the affairs and attachments of the normal group were solely of this type; and the figures, therefore, are hardly comparable.

<sup>3</sup> Noted only in children of at least average ability.

tional aspects. He turns into one of those who, in the phrase of Mérimée, *se passionnent pour le passion*, and becomes one of love's lovers.

In each of the foregoing instances the desire is itself a pernicious one. Living solely for his own instinctive pleasure, the child grows up a glutton, a drunkard, or a libertine. But in many cases the central object which has aroused the permanent interest is comparatively harmless, and is linked with the primitive impulse that inspires the perpetrated crime by a connection far more circuitous and indirect. The boy may have acquired a habit of cinema-going; the girl a hankering for smart clothes or for the glamour of West End life; and, urged by no strong instinct of acquisitiveness or sex, eager simply to

indulge these insatiate cravings, they take to a course of pilfering or prostitution. Or again, a child may slowly develop an absorbing interest in money. At first envisaged purely as a means, as an easy instrument for gratifying his various whims, money comes quickly to be treated as an end in itself. A coin is not the natural stimulus for any inborn impulse, nor is an avaricious greed of itself a crime. Yet, indirectly, out of such cupidity impulsive crimes may, and perpetually do, originate. There is many a young person who finds himself at last utterly unable to withstand the glint of a shilling, or to stop thinking about purses and pockets as accessible receptacles of sixpences, or about the cloakroom as a handy accumulation of such receptacles; so he slinks off to ransack and plunder with something of a miser's purposeless mania for cash as an end in itself.

A true professional interest in crime for crime's sake is unusual among the young. Gambling is almost the only criminal offense which may grow into a self-subsisting passion at a youthful age. Where the older child is making a hobby of theft or other criminal exploits, his passion for them resembles a passion for a form of sport rather than for a lucrative trade or for a career deliberately picked.

## 2. Sentiments of Antagonism

Sentiments of open hatred are comparatively rare. Occasionally—twice perhaps in a hundred cases—one finds a youth so imbued with a fixed passion for revenge that he either commits an assault upon the object of his enmity, or commences a series of defiant, malicious, or exasperating enterprises, solely to vent his vindictive rage. Where a child steals exclusively from a single person, it often proves that the instigating purpose resides, not at all in the use or value of the articles purloined, but simply in the vexation their loss will occasion to the owner. Where another, hitherto a paragon of punctual habits, destitute of any taste for wandering or adventure, plunges, after a month or two in an upper school, or a week or two in a new classroom, into a bout of truancy, it may often be discovered that the sole motive was to shirk a distasteful lesson or avoid a detested



teacher or escape the vexatious company of some insupportable schoolmate.

### 3. Mixed or Ambivalent Sentiments

As a rule, a full analysis will show that the sentiment entertained for a given person is seldom a sentiment of simple hatred or of simple love. Love, however constant, is rarely undiluted, and hatred, however unrelenting, is rarely a pure, unmixed aversion. Most human sentiments are an odd, incongruous, double-edged conjunction of the two. The young, unstable child will sometimes exhibit both aspects with equal clearness, displaying for the same parent or teacher an extravagant affection one day and the next an inordinate antipathy, alternating this way or that simply as the element of tenderness or anger, of submissiveness or aggression, for the moment tips the scale. In children less emotional and more intelligent, as, for example, in the older youth of steady character, sheer consistency of conduct requires that public behavior should be uniform, at any rate upon the surface, that it should manifest only the one or the other of the two incompatible aspects to the apparent exclusion of the reverse. But often the anger and the resentment are only suppressed, not eradicated—checked, not choked. They are perpetually aroused, and keep simmering below the surface, though they never bubble up or boil over. The persons with whom we have to live are the very ones whose daily demands, daily prohibitions, and daily mannerisms, chafe most insistently upon our tenderest nerves. Just because they are dear to us, their idiosyncrasies and their injustices hurt and distress us most. Yet, for the self-same cause, we try to muffle and mask—we try to swallow and keep down—we even try to convince ourselves that we have truly and totally ejected—these petty feelings of irritation and grudge. And, all the while, the inward strife between our love and our vexation, our resentment and our respect, maintains a tension that becomes at last intolerable. In the end, perhaps after some slight, insignificant repulse, the long-standing passion of affection becomes, at a flash, transformed, to the dismay of all beholders, into a sudden and overwhelming paroxysm of rage. The underside of the sentiment

has turned uppermost. And, blinded by some such revulsion of the feelings, the scolded daughter strikes her mother; the exasperated parent thrashes his infant child; the jealous husband strangles his wife; the jilted lover shoots the girl he loves.

### COMPLEXES

Such double-sided sentiments are akin to what in mental pathology are now called complexes. A complex, as we have seen, is an associated system of emotions and ideas which, on account of its unpleasantness, is largely or wholly repressed. Between the sentiment and the complex the difference is mainly one of degree. Both are emotional systems; but the one (to use Professor Pear's illuminating phrase) is a "tidy system," and the other an "untidy system." The one is organized mainly by logical relations, the other by accidental associations, and therefore hardly organized at all. The one is known and acknowledged by its possessor; of the other the possessor is almost wholly ignorant, automatically keeping it shut off from all attention, memory, or awareness. The practical consequence is clear: whereas the motives arising out of a sentiment are usually conscious and rational, the motives generated by a complex are more or less irrational and completely unconscious. How these unconscious motives grow and in what way they exercise their influence may best be understood by tracing the further development of the mixed type of sentiment just described.

#### 1. Stepmother Complex

Among juvenile cases the most important of these double sentiments are to be discovered in the delinquent's attitude towards the parent of the same sex. They give rise to what may be named the Cinderella or stepchild's attitude. Nellie Malone, whose history I have already related, is the most fully analyzed instance of this strange illusion that I have as yet encountered.<sup>4</sup>

---

<sup>4</sup> I may again be permitted to refer to the detailed analysis that I have elsewhere recorded, and to the curious parallel which I have shown may be drawn between the development of such fantasies and the plot

It is commonest among girls. A girl, like all children during the first year or two of life, starts by developing a sentiment in the outset wholly loving and delightful, for her mother. Her mother, throughout that earlier period, is the source of all the joy, succor, and protection that she gets—the bestower, indeed, of almost all that in her simple state of life she needs. As the child grows up, learns to walk unaided, and evolves independent wishes of her own—wishes often at variance with those of the mother—the mother ceases to be for the daughter her only cherisher and preserver, and comes to be looked upon by the willful little egoist as an unsympathetic kill-joy, an unnecessary obstructionist forbidding or defeating all natural and pleasant impulses. New feelings thus creep into the circle of the sentiment. Hitherto the dominating emotions awakened by the mother were tenderness, submissiveness, and a nestling desire for the close physical contact; now it is hostility, dread, aggressive obstinacy, and a desire to flee far from continued restraint, that rise and begin to prevail. Often the other parent, by his more complacent attitude, unwittingly promotes this growing alienation. From his natural fondness for a child of the opposite sex, the father is apt to humor and indulge his tiny daughter, leaving reproof and correction entirely in the mother's hands. If presently the mother transfer her time and attention to the care of some newly arrived baby, or if the father at times display his conjugal affection for his wife, leaving the forgotten favorite for the moment mortified and in the cold, then an unreasoning jealousy or envy intensifies still further the child's estrangement and adds to her gathering enmity towards the parent of her own sex.<sup>5</sup>

Too young to comprehend the true origin of her new sensations, the little malcontent still feels the need for justifying her

---

of the typical fairy tale where the girl is the heroine, as, for example, *Cinderella* or *Snow-White* ("The Dreams and Daydreams of a Delinquent Girl," *Journ. Exp. Ped.*, VI, Nos. 1-4).

<sup>5</sup> The formation of sentiments and complexes relating to parents and other members of the child's family is described in Mr. Flügel's sound and suggestive volume, *The Psycho-Analytic Study of the Family*, a work with which every teacher and all who have to do with difficult children should be acquainted.

unfilial disaffection to herself. A curious but a common solution is afforded by the spinning of droll, self-deluding fantasies like those I have already described.<sup>6</sup> In such a mood she will at times persuade herself that the first mother who was so loving and so lenient and the present mother who is hourly foiling and frustrating every whim must be two distinct individuals, and that the present mother cannot be her own true parent, but a hateful interloper, some foster mother or stepmother with no genuine title to obedience and no real claim upon respect.

To these foolish fantasies accident or fact may sometimes lend support. Should there exist, in the relations of the parents with each other, any hint of the mysterious or the irregular, should whispers (as may easily occur in a delinquent home) reach the child's ear, suggesting that her father or her mother has remarried, or has been divorced, or has quarreled with the other partner, or perhaps has indulged in previous amours, then her imaginative mind feels that there is some color of truth in the romances she is weaving. To deceit or falsehood in their own parents the young are sharply sensitive. When the parents have kept hidden from the child that she is illegitimate or has been adopted, or when (as is still more commonly the case) they have answered her curiosity about sex and birth by evasions or untruths, then, as her eyes are unsealed and the facts dawn at length upon her growing comprehension, her faith in the honesty of adults and in the love of older relatives may be splintered at a blow. Of her new discoveries not a word will be spoken. Shame, shyness, or sheer ignorance and bewilderment as to the true causes of her own *volte-face* will silence her; to her parents and her grown-up friends neither the original enigma nor its supposed solution will be mentioned. The strain, however, cannot endure. At length the girl breaks out. After a phase of unhappy brooding, of inner stress and hidden agitation, the accumulated grievance, heightened and distorted by unwitting additions from her own fancy, fulminates in some seemingly unaccountable rebellion.

Upon a basis of this sort the disillusioned girl may build up

---

<sup>6</sup> See Chapter VIII.

habits of antisocial conduct of almost any form and gravity. With a temperament of the unrepressed type, the pent-up grudge may simply express itself in open disobedience, physical violence, and continual misbehavior in various petty ways. With a temperament the first impulse of which is towards repression, the tormenting strain may at last rebound in some sudden and desperate action, to the unobservant eye quite motiveless and on the surface wholly unrelated to the fundamental trouble. The child, perhaps, will abruptly disappear from home; she may convince herself that she is upon a genuine search for her real father or her real mother; <sup>7</sup> more probably she is seeking, quite unconsciously, for some parental substitute, some kind-hearted stranger who will indulge her wishes and lavish on her the affection, the presents, and the cheap felicity for which she is inwardly hankering. Frequently, she will form some sudden and sinister connection with an older girl or youth who, by some accidental feature, reminds her of the more genial aspects of her alienated parents, and the new companionship may be the starting point of a separate and often disreputable life of semi-independence.

## 2. Authority and Disgust Complexes

With the boy, the history may pursue a similar course, but the sex of the two other members of the triangle will now be interchanged. With the boy, too, the mental processes are usually less involved. The boy's first attachment to his mother is an attachment to a person of the opposite sex; it is, therefore, a relatively permanent one. There is not that curious displacement of affection, so disturbing to the younger girl, when her love is transferred from the mother, who always forms the child's first favorite, to the father, who is generally her second. More often than not, with the boy, as we have seen, it is the father who punishes and scolds and the mother who pets and

---

<sup>7</sup> The delusion may seem incredible in a sane and grown-up girl. But it must be borne in mind that in these emotional moods the individual is temporarily flung back, by part of the general process, to an inner mental condition which is singularly childish and even infantile and constitutes one element of that state of happy babydom to which she is yearning to return.



spoils, and these dual relations are preserved from the earliest years until the latest. The boy's standpoint towards the father becomes, accordingly, one of open revolt and active insurrection. He forms and maintains a lasting attitude of resistance towards all quasi-paternal authority, and any person or institution that by the exercise of such authority reminds him of his father—whether schoolmaster, employer, police, or magistrate—school, church, office, firm, or even society as a whole—is apt to re-arouse the same ingrained feeling of hostility.

This double or "ambivalent" disposition towards the parent of the same sex—a negative disposition of hatred, usually repressed, coexisting side by side with a positive disposition of outward love and with an apparent deference itself a little forced and overdone—is a feature almost as common in the history of the neurotic patient as it is in that of the delinquent. In the neurotic, however, as Mr. Flügel has pointed out,<sup>8</sup> the positive or love aspect gains, as a rule, the ascendancy. In the delinquent, if my brief records may be trusted, the negative or hate aspect seems in general to prevail. And we are led to conjecture that, in such cases, there is probably at work some additional motive, strengthening and sustaining the antagonistic tendencies. Of this further reinforcement the source is somewhat obscure. One recurrent symptom in the history of the disaffected child is at least suggestive. It is, as we have already noted, the nature of many a shameless offender to find disgusting things not repellent but piquant, not painful but pleasing. Activities connected with everyday physiological processes—eating, drinking, washing, dressing, and excretion—are not, as with the normal child, controlled into decency by the unpleasant repugnance they naturally arouse, but seem rather to provide an occasion for a depraved form of pleasurable excitement—for indecorous habits and gross practices whose object is to gain for the young pervert the thrill of a mild, self-caused disgust, and perhaps also the glee of revolting his companions and the glory of scandalizing his elders. During earlier years, it falls upon one or other of the parents, usually upon the mother,

---

<sup>8</sup> *The Psycho-Analytic Study of the Family*, p. 117, cf. also *ibid.*, p. 177.

to check these offensive inclinations. The methods of restraint are often stern and summary; they end by promoting in the tiny child, not a fastidious cleanliness, as they are meant to do, but simply an added obstinacy and opposition. He thus, from the very first year of life, begins to develop a notion of his mother as one whom it is easy to shock—one who is always unwarrantably interfering with his most private and pleasurable functions. The former notion puts into his hand a ready weapon: to do repulsive things becomes, by daily experience of its effects, a cherished and convenient symbol for expressing social defiance. The latter feeling—the sense that the keener physiological pleasures have always been regularly disturbed by the parent—helps greatly to foster and swell the later childish resentment, which, as above described, is so easily set up, even in an infant less lost to shame, on a foundation of wounded love or jealousy.<sup>9</sup>

### *Moral Conflicts*

From what has just been said, and from many, if not most, of the illustrative histories scattered across these pages, the reflective reader will have perceived that there is one state or moment in the delinquent's career that is supremely critical—the state of moral conflict. In case after case, we have watched the emerging of a mental struggle between two inconsistent emotions, and have seen how the tension thus set up forms one of the most frequent preconditions, and provides one of the most provocative occasions, for an outburst of wrongdoing. It is time, therefore, to glance more closely at the nature of these inward contests.

The struggle, in the last resort, is a struggle between a pair of instinctive impulses, opposed and equally matched. Where

---

<sup>9</sup> To the reader unfamiliar with the crude, half-unconscious processes of the childish mind, the above account must seem far-fetched. I should explain that it rests, not upon mere surmise and speculation, but upon verifiable statements offered in explanation by several youthful offenders and generally confirmed by their parents' memories. The view that I have here put forward finds, in addition, some statistical confirmation in the fact, shown clearly in the tables (see Table XVII), of greater infantile incontinence among young delinquents.

one and the same situation excites two incompatible instincts, a distressful state of suspended reaction must for a while ensue. A solitary child seeing a tart upon the pantry shelf may be moved, first, by a natural desire to take and eat the tart, and almost simultaneously by a dread of the punishment to follow. Where neither impulse has behind it any further reserve of force, the battle is brief; the stronger instinct (as a rule, the one aroused most directly by the stimulus actually present to the child's eye) soon gains the day. But should one or other of the instincts (for example, that of fear) be fortified by some powerful sentiment (for example, a respect for parental authority), then usually the second, unsupported, will be at once overborne. But if, again, that other is also kept alive, whether by the recurrence of its stimulus (as the child, perhaps, passes and repasses the open pantry door), or by the persistence of some underlying mood (abiding hunger, it may be, in the case we have supposed), or, possibly, by some strong sentiment of its own (conscious liking for tarts as such or, in subtler instances, a self-pitying envy of richer companions or older parents who can eat as many tarts as they want), then the clash between the two contending impulses, thus severally and differently reinforced, may be interminably prolonged.

As a rule, in a child whose emotions are well balanced and whose intelligence is well organized, and in a social setting that is sufficiently plastic and adaptable, some harmonious adjustment is at length worked out, some compromise which reconciles—as it were, by a higher synthesis—the two competing desires. The hungry youngster says in effect: "I won't take the tart straight away. But I won't give it up. I'll go and ask mother if she can spare it."<sup>10</sup>

Too often, however, the issue is not fought out to any reasonable conclusion, but simply shirked and shelved. Seen from

---

<sup>10</sup> The solution of such ethical dilemmas depends, usually and in part, upon the making of an intellectual distinction. The child discriminates the legitimate from the illegitimate elements in his natural desires. It is here that the sympathetic instructor can often give valuable assistance to the young or unintelligent person, helping him to find a middle way between wholesale self-denial and thoughtless self-indulgence.

outside, indeed, one impulse may appear to have been victorious and the other to have been defeated and effaced. Yet the conquered impulse is not exterminated, but merely suppressed; not quenched, but only quelled. Undestroyed and indestructible, it is driven beneath the surface. There it festers like a hidden abscess and must at length discharge. Mental energy, like physical, is imperishable. Once it has accumulated and once it is set working, some outlet it must find. If the natural and more obvious openings are blocked, it bursts out eventually through some unexpected breach that it forces for itself. Gluttony, perhaps, has subjugated fear, and the child has stolen the tart, saying, "I shan't be found out; so I'm not afraid." Having licked out the jam and crammed down the pastry, he is startled to find himself drifting into a mood of uneasy apprehension or of insincere defiance. His original misgivings, smothered yet not dispelled, have rallied in some dark corner of his mind, and have there secretly reorganized themselves into the particular type of complex known to the moralist as a guilty conscience.

Or, perhaps, on a different occasion, the outcome has been reversed. The child may have retired from the scene of temptation, telling himself, "I'm not really hungry; and I can do without the tart." Ten minutes later, he is found in a storm of tears, or (as in another instance recently observed) furiously smashing in the grate the baby's bottle of milk.

Such, on a primitive scale, is the general nature of a moral conflict. The plainest instances are seen in what we term temptation. Every temptation is a trial of strength between two rival impulses. It is a special form of conflict described and discussed from the days of Aristotle and St. Paul. But what has never been so well recognized is this: to fly from temptation may be quite as disastrous as to yield to it. The proper course is neither to give in nor yet to shuffle out, but to see the issue through to a finish. Both tendencies must be mutually adjusted and taken up together into the main fabric of the mind. If one is left unincorporated and unabsorbed, it maintains a covert fight for existence by itself, like some rejected alien intriguing on the outskirts of a closely disciplined camp.

The child's total personality then becomes, as we have learnt to say, dissociated; it suffers a sort of mental breakage, and splits into two unequal and antagonistic portions. The smaller portion, disowned and discarded by the major, is technically described as repressed. What is repressed will sooner or later reëmerge, but usually in a form distorted and disguised. The child who persuaded himself he was not hungry, when in point of fact he was famished, presently finds his discomfort avenging itself by starving his infant brother of his food. Here, indeed, at its simplest is the mechanism of what we have so often found occasion to allude to—substitutional delinquency. The mechanism consists essentially (if I may borrow from the plumber a homely hydraulic metaphor) in the phenomenon of "side-burst." It should be added that in most forms of what is called temptation the person tempted is aware of the strife within his soul. In the subtler forms of mental conflict, he is not: repression is automatic and unconscious. The child may deny that he was ever tempted at all; and may, by the self-deluding process known as rationalization, offer in all sincerity some transparent and baseless excuse for his eventual outbreak—saying, for example, as in the instance just cited, that the innocent victim of his vengeance had done him some fantastic wrong.

Whether the child succumbs to the temptation or represses it must depend in part upon his own constitution and in part upon the social influences in the midst of which he moves. The children who succumb are children of a temperament that we have learnt to recognize as impulsive and unrestrained. Those who crush down their temptations without openly facing them are generally the restrained and self-obstructed—the moody, the silent, and the sensitive, those shrinking flutterers whose inhibiting emotions, fear, disgust, and the like, are usually uppermost and keep the more aggressive in due subjugation; as a rule, the intelligence of such children is well above the average of the ordinary run of juvenile delinquents, and their mental imagery vivid and persistent. The rough, dull-witted, boisterous hooligan, who lives and revels in the present moment and for whom all that is out of sight is out of mind, rarely submits



to prolonged internal struggles and seldom curbs his stronger instincts." <sup>11</sup>

Of the social conditions making for repression, the commonest are, first, the presence in the child's family or among his closer companions of a puritanical code or tradition—a tradition that demands the concealment of all emotion, a code that inculcates contempt for primitive passions of whatever sort; and, secondly, the absence, alike from his family and from his chance acquaintances, of any sympathetic confidant who might show an understanding of the child's moral problems and lead him to discuss and ventilate them. A quick, imaginative boy or girl, the only child of elderly parents whose habits are austere and whose feelings are already aged and withered, stands in a most suitable situation for the development of repressions. My most tragic and perplexing cases have arisen amid such homes as these. Limits of space preclude me from offering any fresh case histories illustrative of these mental mechanisms. Already we have seen such processes at work in many of the examples brought forward under other heads. For fuller details in a typical instance I may refer to my study

---

<sup>11</sup> The average mental ratio of my "repressed" cases is 107—decidedly above that of the ordinary child. The average mental ratio of all the delinquent cases, it will be remembered, was only 89.

In the group here studied, although conflict, with or without repression, is by no means confined to the neurotic and hysterical, nor even to unstable and restrained or sensitive temperaments, yet, so far as my figures can be trusted, it is far less frequent among the stable and among those of the unstable whom I have termed unrestrained. Healy, indeed, whose admirable study of some forty cases of *Mental Conflicts and Misconduct* should be consulted by all, declares that "no special type predominates" among them (*loc. cit.*, p. 316). "Mental conflict," he says, "commonly produces misbehavior in individuals who prove themselves by examination and history to have, apparently, normally stable nervous systems; . . . anything approaching the 'shut-in' type is very rarely seen. . . . We can find no evidence of conflicts especially afflicting individuals of a general subjective temperament" (pp. 313-15). All this, as it stands, differs, indeed, from my own experience. Healy, however, goes on to remark "it must be that those who are thus affected are decidedly sensitive beings. . . . We recognize that in some instances we have had to do with hypersensitive individuals" (p. 315, *cf.* also p. 9). Hence, it would appear that the divergence between us is chiefly a matter of emphasis and of degree.

of the girl thief, alluded to above and published at some length elsewhere.<sup>12</sup>

The particular forms that mental conflict may assume are multifarious. But among all the possible types none are so common or so characteristic as those issuing from a disharmony between some inborn instinct on the one hand and some acquired sentiment upon the other. The instincts born in us are, as we have seen, adapted to life in primitive uncivilized conditions; the sentiments we acquire are adjusted to life in civilized society. What else is to be expected but that at times the two should violently collide? Accordingly, in most cases of repression, it is a sentiment that represses and an instinct that is repressed.<sup>13</sup>

### 3. Sex Complexes

In a modern community, of all the primordial instincts, that which requires the most rigorous restraint, at any rate among persons the more mature, is the instinct of sex. It is not surprising, therefore, that, influenced no doubt very largely by analyses of neurotic adults, all writers on delinquency should have dwelt with emphasis on the far-reaching consequences of sex repression. Our conventional reticence, our traditional taboos, everything that in the well-bred youth fosters a strict ideal of decent and decorous behavior, is apt to leave him during early manhood, with his sexual instincts not only unsatisfied, but entirely ignored—cut off from all interaction with uttered thoughts and avowed ideas. For this very reason, the few stray notions, the few sporadic memories, associated with the general topic of sex, being themselves smothered up so soon as they arise, tend immediately to coalesce with the central and suppressed emotion. They crystallize about it beneath the surface

---

<sup>12</sup> *Journ. Exp. Ped.*, VI (1921), *loc. cit.*

<sup>13</sup> Such conflicts are sometimes described (*e.g.*, by followers of Mr. Trotter's doctrines) as conflicts between the social or herd instinct and some egoistic instinct, or again (*e.g.*, by followers of Freud) as conflicts between the ego-instincts and a sex impulse. The repressing force, however, in the former case seems not so much a social instinct as a social sentiment, and in the latter not so much an ego-instinct as an ego-sentiment, a sentiment of self-respect or self-maintenance.

of the mind, like precipitated chemicals round some impurity in the solution. And the whole thus forms a submerged or subterranean sentiment, an unconscious interest with an activity, an energy, a life of its own: in a word, a complex.

In the child, it is true, repression seldom seems so absolute as in the neurotic adult. He tries to forget, but there is rarely a genuine loss of memory; rather, a tacit intermittent rumination over the issue that has been raised. The real trouble may have started either in sex knowledge surreptitiously acquired or in unsuspected sexual shocks and experiences, or, perhaps most frequently, in privy temptations of a simple sexual kind. Note that it is not the mere possession of sex knowledge or of sex temptations that becomes the real provocative; it is the repression of the knowledge or temptations so possessed. When this occurs, the usual outcome is not, paradoxically enough, a transgression of a sexual type, but some crime or misbehavior of a seemingly irrelevant nature. Here, indeed, are found the commonest cases of substitutional delinquency. The child, half automatically, half from a conscious horror, seems to be shunning what he considers the greater sin and indulging—by way of a distraction or relief—in some lesser criminality, in some venial but forcible counterblast which opens up a channel of discharge—stealing, violence, running away. Generally, through a connection unknown to the delinquent, through some blind filament within the brain, the substituted act is remotely linked to the original temptation. Often the substitution is of the symbolic type, as in the case of Nellie Malone: stealing may symbolize a sexual act; running away may signify dread of some disquieting crisis or a mental flight from a mental problem. In other instances the association is one of simple contiguity in time or place. Perhaps in the room or park where he now plans his new escapade, the child has witnessed some lewd transaction sexual in its nature. Perhaps he has known in the past some profligate companion, some half-forgotten initiator, who once familiarized him with the practices—or perhaps only with the ideas—both of sexual misconduct and of the recent substituted offense. The experience has passed into oblivion, but its effects have not been blotted from his brain. Some reminder in his present

situation has plowed up from beneath the surface of his consciousness a buried memory of things long past; some coincidence has evoked a lingering reminiscence of his earlier friend, and with it the former seduction. Recoiling from the coarser impulse, he flings himself into the milder of the two associated vices, which the thought of his old corrupter had thus simultaneously rearoused.

#### 4. Complexes of Inferiority and Self-Assertion

Sex conflicts seem commoner in older children from better class homes. Among younger children the instinct that, at all events in certain families and certain schools, is repressed most frequently and most consistently is the instinct not of sex, but of self-assertion.<sup>14</sup> In humble dwellings where harassed parents and numerous brothers and sisters are all huddled together in the same over-populated room, sexual affairs can seldom be wrapped up for long in any veil of mystery. On the other hand, in such a family, from the very earliest days, the child's natural impulse to assert himself has ruthlessly to be put down. Much misconduct, serious as well as trivial, is a morbid reaction from this constant, stifling constraint. Here, too, lurks the danger of institution discipline for delinquents of an unstable and excitable stamp. The effects of the coercion are much as before. The cramped and suffocated instinct ramifies once again into an underground complex, a rank, deep-rooted growth, that evinces in its structure the strength, the persistence, and the intricacy of a sentiment, and is quite unlike the simple flash-in-the-pan eruption of an elementary impulse. Nearly every child, so long as he is a child, surrounded and subdued on every side by big, intimidating adults, is apt to develop what is loosely called an "inferiority complex."<sup>15</sup> Where the inferiority, in-

---

<sup>14</sup> It is instructive in this connection to remark that the daydreams of younger children are mainly fantasies of self-assertion and self-glorification; and seldom, before adolescence, deal with amorous or erotic themes.

<sup>15</sup> In Tables XX and XXI I have used the phrase "superiority complex" to cover those that are technically termed narcissistic. But, like so much psychological classification and nomenclature, the implied distinction between a superiority complex and an inferiority complex is

evitable to childhood, is still further aggravated by some physical defect or deformity, by some stain upon his birth or some disgrace hanging over his history, the protesting victim is apt to compensate himself with illicit luxuries and treats, and—almost justifiably, as he may persuade himself—to make up for what he lacks in natural gifts and social privileges by what he can procure by nimbler cunning and agility. His sense of justice is not wanting: it is super-refined; and is exercised chiefly in reference to himself. He feels, over some small trifle, that he has been wronged: his feeling may be warranted; his wrong may be real; but, unable to explain his case or to secure legitimate redress, he chafes and magnifies his grievance, and at last either seeks to indemnify himself in his own clumsy way, or sits gloomily hugging a sore and ineradicable grudge. In the end, his conception of himself—his “self-regarding sentiment,” in McDougall’s terminology—may come to be that of the martyred innocent, the victimized, self-vindicating rebel, with Claude Duval or Rob Roy MacGregor as his hero and his ideal.

Conflicts springing from the self-assertive instinct or the self-regarding interest, though they may occur during the earliest years of childhood, yet exhibit their results most plainly about the school-leaving age and towards the time of adolescence. It is then that the child’s sentiment for himself comes so incessantly into competition with his sentiment for his parents. There is, as we have seen, about this period a great growth in independence and a sharp increase in the desire for self-reliance and self-guidance. The youth has now to put away childish things and to break away from the old home ties; the emancipation is often doubly difficult, just because his attachment to his mother or father is so enduring and devout. Where the clash is not external but internal, where the collision occurs, not openly between a hardy, heartless youth and a stern, despotic parent, but inwardly, on the battle ground of the child’s

---

usually one of degree or aspect. Here, as elsewhere, the positive and the negative forms of the same complex are, more often than not, found in combination in one and the same individual. And this double-faced character of our self-regarding interests is not without significance for the practical understanding and treatment of the child.



divided mind, between his expanding need for an autonomous existence and his lifelong habit of deference to his parents, there the effects are catastrophic.<sup>16</sup> Torn between piety and personal pride, the delinquencies to which in his desperation the struggling youth at length gives way have, in nearly every case, a pathological complexion, some taint or tinge of madness. They are sometimes the first of their kind in which the child has indulged, and may be so contrived that it seems preposterous that he should hope to reap from them anything but misery and disappointment. With every possible comfort in his home, he yet prefers to pass his nights in the open. With all his wants supplied to him for the asking, he yet commits the most astounding thefts. Ultimately, perhaps, he absconds altogether, fired by some crazy project of starting life anew in another town or country. The most serious, the most obstinate, and the most elaborately planned offenses that I have at any time encountered, have issued from moral conflicts of this type in the spoilt but mutinous inmate of an affluent home.

In his effeminate heart

There is a careless courage, latent energies  
Repress'd by circumstance but not destroyed,  
Steep'd but not drown'd.<sup>17</sup>

Mental discord may arise, not only between personal sentiments such as those above described, but also among sentiments that are abstract and ideal, like the somewhat philosophical interests centering upon religion, duty, marriage, or one's own career. Conflicts, however, of this intellectual quality are, from their very nature, rare among delinquents of the age and class of the ordinary elementary schoolboy.<sup>18</sup> And, further, it

---

<sup>16</sup> I have used the masculine pronoun; but in adolescent girls the process is yet more acute. Mr. H. G. Wells's novel *Ann Veronica*, based as it so patently is upon the actual experiences of a modern girl, offers a vivid portrayal of the inner aspect of such a contest, a contest between the parent resolved to be absolute and the child resolved to be free.

<sup>17</sup> Byron, *Sardanapalus*, I, i, 10-13.

<sup>18</sup> Most of my cases of this quasi-metaphysical type have been from training college students, among whom worries about hell and immortality are still far from uncommon. Among children of the elementary

is only upon the surface that the issue is academic and theoretical. The contending views draw their persistence and their intensity from the fact that they are, in their fundamental origin, simply rationalized by-products of deeper and more intimate emotions.

### Frequency of Particular Complexes

Repressed complexes are not so much themselves the causes of crime as part of the mental machinery through which the ulterior causes operate. I have classed them as principal factors whenever the delinquency was at length cleared up by a protracted analysis or whenever the child showed a visible amendment after removal from a source of current conflict. They were traceable, usually without much difficulty, in more than 57 per cent of my cases—being found more frequently, or at all events more easily, among the girls than among the boys. In 15 per cent the development of such a complex seemed fairly assignable as the main origin of the child's offenses (see Table XX).<sup>19</sup> In a small proportion of the cases marked by the formation of complexes, there were also, for special reasons not always easy to discern, neurotic or psychopathic symptoms, sometimes slight, more rarely grave, combined with the moral disorder. In most instances, however, though the complexes

---

school class, the nearest approach to such conflicts is the not infrequent perplexity that the bright boy or girl from a poorer home experiences in reconciling the two different ethical standards with which he is so constantly confronted—the more refined code of the school, for example, and the rougher code of the home or street; or, later on, the stricter code of his home with the looser code of his friends and associates in work and recreation. In such a case I have sometimes known an intelligent and reflecting youth, after prolonged and painful pondering, to throw up in distraction the whole bewildering issue, proclaim himself an atheist or anarchist, and act in flagrant accordance with his new-found philosophy.

<sup>19</sup> My figures are far higher than those given by Healy. Both in his first and second series of delinquents the proportion of cases showing mental conflict was but little over 7 per cent. (*Individual Delinquent*, p. 130; *Mental Conflicts and Misconduct*, 1917, p. 8). Healy, however, was handling larger numbers, and, as he points out, the practical requirements of court work must have debarred the needful exploration in many of the young people studied. He writes: "We are far from contending that this number represents the true total" (*loc. cit.*, p. 8).

TABLE XX.—PSYCHOLOGICAL CONDITIONS, EMOTIONAL, ACQUIRED: COMPLEXES AND MORBID EMOTIONAL STATES

	DELINQUENT					NON-DELINQUENT		
	Boys		Girls		Aver.	Boys	Girls	Aver.
	Major Factor	Minor Factor	Major Factor	Minor Factor				
<i>Complexes: 1</i> .....	11.4	37.4	12.3	59.5	57.4	14.0	23.0	18.5
Auto-erotic.....	—	[9.0]	—	[8.1]	[8.6]	—	—	—
Superiority (narcissistic).....	[1.6]	[26.0]	—	[23.0]	[25.9]	—	—	—
Inferiority.....	[1.6]	[10.6]	—	[8.1]	[10.6]	—	—	—
Parental (untransferred).....	[4.1]	[13.0]	[2.7]	[17.6]	[18.3]	—	—	—
Parental (transferred).....	[4.1]	[19.5]	[5.5]	[20.3]	[24.4]	—	—	—
Conflicts about parentage.....	—	[4.9]	[1.4]	[14.9]	[9.1]	—	—	—
Sexual.....	—	[5.7]	[2.7]	[9.5]	[8.1]	—	—	—
Fantasies or day-dreams.....	—	7.3	—	16.2	10.6	2.5	9.5	6.0
<i>Neuroses:</i>								
Neurasthenia....	—	3.3	—	2.7	3.0	1.0	—	0.5
Anxiety states...	—	0.8	—	4.1	2.0	—	1.5	0.7
Obsessive thoughts	0.8	1.6	1.4	4.1	3.5	—	—	—
Compulsive actions	0.8	—	—	—	0.5	—	—	—
Hysteria.....	—	—	1.4	1.4	1.0	—	—	—
Minor psychoneurotic states <sup>2</sup>	—	4.1	—	5.4	4.6	—	0.5	0.2
<i>Psychoses and other psychopathic conditions:</i>								
Dementia præcox	—	—	1.4	—	0.5	—	—	—
Minor psychopathic states...	—	1.6	—	2.7	2.0	—	0.5	0.2
<b>Total.....</b>	<b>13.0</b>	<b>56.1</b>	<b>16.5</b>	<b>96.1</b>	<b>85.1</b>	<b>17.5</b>	<b>35.0</b>	<b>26.2</b>

<sup>1</sup> Different types of complex and different aspects of the same type of complex are, as the figures show, continually combined in one and the same individual. The percentages given in the first line of the above table are based on the total number of children showing one or more definable complexes. Hence, they, and the totals of the percentages for the various types of complex (given in the seven following lines of the table), differ both from each other and from the totals given at the foot of Table XXI.

No study or analysis of complexes was undertaken with non-delinquents. A note was made, however, of children markedly repressed (see Table XVIII). In default of other evidence, it may be assumed that the number of cases showing complex-formation (due to repression, both mild and marked) bears about the same proportion to the number of cases showing marked repression only, in both delinquents and non-delinquents: such a proportion, calculated separately for the two sexes, supplies a broad estimate of the frequency of complexes among the non-delinquents. This estimate has been entered at the top of the last three columns of the above table for purposes of rough comparison.

<sup>2</sup> Chiefly mild hysterical conditions.

disinterred usually resembled those found in a typical neurosis, the chief abnormal symptoms were delinquent habits and no more.

Many of these complexes are indeed complex, and that to the highest degree. So manifold are their varying elements and so intermixed their distinguishable aspects that to make any abstract summary of them becomes a hard and baffling task. For the sake of those, however, who are interested not only in delinquency but also in psycho-analytic work generally, I have attempted to classify and count all the commoner factors I have met with. The figures are shown in Table XXI. To the analyst the headings, if at times unorthodox, will sufficiently explain themselves.<sup>20</sup>

Adopting the broad distinctions implied in the table, it appears that as many as 43 per cent of the delinquent children revealed well-marked complexes of what may be called a parental type (compare Table XX, lines 5 and 6); in most of these, indeed in 24 per cent of the whole group, there had been a transference of the emotions so generated from the parent to some parental substitute—to a foster parent, a brother, a sister, or another relative, or (in nearly 7 per cent) to a teacher. Mental conflicts about birth or parentage, sometimes justified, sometimes not, were found in 9 per cent of the cases. What I have termed self-regarding complexes—complexes of inferiority or superiority—were, if anything, even commoner than parental complexes, being, of course, frequently conjoined with these; they occurred in 36 per cent of the cases. So-called auto-

---

<sup>20</sup> In the table each type of complex has been recorded separately under a heading of its own. Thus, though the cases analyzed are relatively few, the total entries are considerable. In spite of this, the figures shown for the frequency of such mechanisms still yield, in all probability, a gross underestimate. Analytic treatment could only be undertaken when there seemed a reasonable likelihood that it might issue in a practical benefit, or at least cast a gleam of theoretical light upon the genesis of the mischief, and even then, from the exigencies of my work, it was impossible to push home the analysis in every case with ideal completeness. With the delinquent boys, in particular, this mode of approach proved difficult and slow, and here, most of all, the percentages may be too slender.

TABLE XXI.—DETAILED ANALYSIS OF COMPLEXES OBSERVED

	DELINQUENT				Average
	Boys		Girls		
	Major Factor	Minor Factor	Major Factor	Minor Factor	
<i>Auto-Erotic Complexes:</i>					
Genital <sup>1</sup> .....	—	3.3	—	2.7	3.0
Oral.....	—	2.4	—	4.1	3.0
Urethral.....	—	0.8	—	1.4	1.0
Anal.....	—	7.3	—	2.7	5.6
<i>Self-Regarding Complexes:</i>					
Superiority Complexes (narcissistic):					
Morbid self-assertion: (anti-authority complex).....	1.6	8.1	—	4.1	7.6
Morbid self-assertion: (wish for power; sadistic).....	—	3.3	—	—	2.0
Morbid self-love: personal vanity..	—	1.6	—	6.8	3.5
With homosexual aspect.....	—	0.8	—	1.4	1.0
With frustrated mother fixation (starved affection) <sup>2</sup> .....	—	3.3	—	5.4	4.1
With continued mother fixation (chiefly from spoiling during convalescence).....	—	4.1	—	2.7	3.5
With belated mother fixation (partial struggle against dependence)..	—	6.5	—	4.1	5.6
Inferiority Complexes:					
Physical.....	1.6	3.3	—	1.4	3.5
Mental.....	—	2.4	—	4.1	3.0
Sexual <sup>3</sup> .....	—	—	—	2.7	1.0
Social.....	—	9.0	—	4.1	7.6
<i>Parental (without transference):</i>					
Attachment to father.....	—	2.4	—	9.5	5.1
Antagonism to mother.....	1.6	1.6	2.7	6.8	5.6
Attachment to mother.....	—	9.0	—	8.1	8.6
Antagonism to father.....	2.4	10.6	—	5.4	10.2

<sup>1</sup> Chiefly masturbatory, with guilt. Masturbation unaccompanied by conflict of repression is, of course, not included in these low figures.

<sup>2</sup> Includes sense of being an "unwanted child" (often justified).

<sup>3</sup> Castration type.

erotic complexes (in which I include the excretory) occurred in 9 per cent. And sexual complexes (in the narrower sense of the word sexual) in only 8 per cent.<sup>21</sup>

<sup>21</sup> The lay reader would doubtless apply the term "sexual" to many of the complexes here called auto-erotic, while the strict Freudian would apply the same term to most of the complexes I have called parental and narcissistic. Possibly my caution in groping for sexual complexes may have resulted in an underestimate of the sexual components. But I



TABLE XXI.—DETAILED ANALYSIS OF COMPLEXES OBSERVED—*Continued*

	DELINQUENT				Average
	Boys		Girls		
	Major Factor	Minor Factor	Major Factor	Minor Factor	
<i>Parental (with transference):</i>					
Antagonism to stepfather . . . . .	—	0.8	—	—	.5
Attachment to stepmother . . . . .	—	—	—	2.7	1.0
Antagonism to stepmother or foster-mother <sup>4</sup> . . . . .	0.8	4.9	2.7	5.4	6.6
Attachment to elder brother . . . . .	—	—	—	4.1	1.5
Antagonism to elder brother . . . . .	—	4.9	—	1.4	3.5
Attachment to elder sister . . . . .	—	3.3	—	—	2.0
Antagonism to elder sister . . . . .	—	0.8	1.4	2.7	2.0
Attachment to younger brother or sister . . . . .	—	1.6	—	2.7	2.0
Antagonism to younger brother or sister <sup>5</sup> . . . . .	1.6	2.4	1.4	4.1	4.6
Attachment to stepsister . . . . .	—	1.6	—	—	1.0
Antagonism to stepbrother or sister . . . . .	—	2.4	—	4.1	3.0
Attachment to female cousin in the same home . . . . .	—	1.6	—	—	1.0
Antagonism to teacher . . . . .	1.6	5.7	—	5.4	6.6
<i>Conflicts about Parentage:</i>					
Warranted <sup>6</sup> . . . . .	—	4.9	1.4	9.5	7.1
Unwarranted . . . . .	—	—	—	5.4	2.0
<i>Sexual Complexes:</i>					
Actual heterosexual experiences <sup>7</sup> . . . . .	—	1.6	2.7	4.1	3.5
Actual homosexual experiences <sup>7</sup> . . . . .	—	3.3	—	1.4	2.5
Repressed sexual temptations . . . . .	—	0.8	—	2.7	1.5
Birth problems <sup>8</sup> . . . . .	—	1.6	—	4.1	2.5
Total . . . . .	11.2	122.0	12.3	137.3	138.9

<sup>4</sup> Including female relatives or guardians acting in that capacity.

<sup>5</sup> Chiefly jealousy of infant children, but includes one instance of jealousy of a petted older brother dating from the time he was crippled.

<sup>6</sup> The child being actually illegitimate or a stepchild.

<sup>7</sup> Repressed experiences only; unrepressed experiences are not included.

<sup>8</sup> Including one pubescent girl with morbid fear of pregnancy.

Compared with the neurotic child, delinquents appear to manifest a disproportionate number, or at least a disproportion-

cannot think the omissions large. Among neurotic children, with the same or even a greater caution, I find repressed sexual complexes nearly three times as common as among delinquents. The fact seems to be that, among delinquents, sexual tendencies and sexual interests are less frequently repressed.

ate strength, of certain of the more primitive complexes—particularly the auto-erotic, the self-regarding, and the simpler phases of the parental; often the child's emotional development seems to have suffered a partial arrest or fixation at these more infantile levels. The more elaborate form of sexual complex is, among delinquents, far less frequent. All these different kinds of complex are woven almost inextricably the one with the other. Those that chiefly appear as major factors are parental complexes—antagonism to the father being commoner among the boys and antagonism to the mother among the girls. Inferiority and authority complexes play the sole or leading part only among the boys; sexual complexes and conflicts about parentage (so far as these few cases go) only among the girls.

No doubt, in a more innocent shape, complexes similar to those encountered among the delinquent and the neurotic could with sufficient digging be unearthed among the normal. Indeed, in spite of all the thorough work by the various psycho-analytic schools, it still remains an unsolved mystery why complexes apparently identical should produce abnormal symptoms in one person and none at all in another. With delinquents several factors seem to further this unfavorable development: defective family relationships must obviously cast the usual parental complexes into a very unusual mold; an over-strict or an over-indulgent discipline—particularly if the two alternate within the same household—must render the conflict more acute; a general instability in the child himself or an over-activity of some isolated instinct—sex, anger, self-assertion, and pleasurable disgust—will intensify any lack of emotional equilibrium; and other instincts—timidity, diffidence, and unpleasant disgust—may make for increased repression; finally, countless occurrences in the outer and inner history of the offending child—removal from home, quarreling at home, immorality at home, with their silent effects upon his mind, and outside the home pernicious companions or painful experiences—all serve to give a special trend to his unconscious emotional development and to hamper the progressive unfolding of his character along normal cultural lines.

## Treatment

Once more, within the compass of the present work, I can do little more than show how the accepted principles of psychotherapeutic treatment may, with a few needful modifications, be adapted to delinquent cases. For the details of such treatment the interested reader must be referred to the many handbooks written on that special subject.<sup>22</sup>

### 1. *The Detection of Conflicts and Complexes*

The first and most urgent step is to discover the undesirable complex or sentiment when it exists and to determine what processes of repression and conflict are actually at work. Where an intelligent young person with no obvious reason in his surroundings or in his own mental make-up, takes to a protracted career of crime that brings no obvious gain and yields to no ordinary measures, there some lurking emotional struggle is always to be suspected. And so long as hidden causations are active, none of the usual methods—neither punishment nor reward, remonstrance nor confinement—can ever be expected to arrest the delinquency.

Often the parent, the teacher, and the probation officer have all come to realize from the peculiar nature of the boy's offenses that there is something (as they phrase it) "on his mind"—or rather something in his mind or at the back of it—that has never been brought to light. Seldom, however, do they grasp

---

<sup>22</sup>For a short general account of the nature of mental conflict and repression the reader may study Bernard Hart's little book on *The Psychology of Insanity* (Cambridge University Press, 1912). To the subject of psycho-analysis the best introductions are S. Freud, *Introductory Lectures on Psycho-Analysis* (trans. J. Rivière, Allan & Unwin, 1922), and E. Jones, *Papers on Psycho-Analysis* (Baillière, Tindall & Cox, 3rd ed. 1923). For a recent application of the doctrine of unconscious motives to criminology see M. Hamblin Smith, *The Psychology of the Criminal* (Methuen, 1922). On the psycho-analytic study of young children perhaps the most suggestive contributions, apart from the works of Flügel and Pfister already cited, are those of von Hug-Hellmuth, particularly *A Study of the Mental Life of the Child* (Nervous and Mental Disease Monographs, No. 9), and of Melanie Klein, particularly "Zur Früh-analyse" (*Imago*, IX, 1923, pp. 223-59) and "The Rôle of the School in the Libidinal Development of the Child" (*Int. Journ. Psycho-Anal.*, V, 1924, pp. 312-31).

the fact that direct interrogation of the child himself is all but worthless, that a special mode of approach is requisite. Without expert handling and the most delicate advances, the child will not, dare not, and perhaps cannot, tell. How ignorant fathers and mothers can be of their child's outward habits we have already had occasion to notice. Is it likely that they should know more of his inward life? The amazing way in which the tiny child of eight or nine, to all appearances the very perfection of radiant innocence and charm, may yet contrive to live a covert and corrupt existence of his own, is strikingly portrayed in Henry James' weird story, *The Turn of the Screw*. But conscious concealment is the smallest of the obstacles. Quite as often, the underlying causes and incentives are completely shrouded from the child himself. Straightforward questioning, therefore, is of no avail, because the child does not know the true answer. The experienced observer, in the outset, can trust only to the general features of the case, and to some few incidental tokens—to "complex symptoms" as they are sometimes termed—which the child may betray during the interview or the testing.

## 2. *Psycho-Analysis*

The discovery of the precise nature of the conflict and its specific treatment and relief must follow so-called psycho-analytic methods. To analyze is to untie, and the object of psycho-analysis is to loosen the twisted knots in which the soul is tangled. The analyst must strive to disengage all the implicated motives of the child, unconscious as well as conscious, so that both the child and himself may become fully aware what hidden bonds encumber him. In this proceeding, the main feature will be a tactful effort to extract from the young patient his own biographical story. The psychologist will begin by convincing the child that the sole purpose of the discussion is to help him, and particularly to help him to understand himself, not to punish him, not to reproach him, not to hand on his closely guarded secrets to his parents or his teachers, much less to indulge an idle curiosity about what after all are his private and personal affairs. The child must be persuaded to

pour out frankly and fearlessly all the thoughts and feelings that come into his mind, however foolish, however unseemly, however humiliating they may be, without moral or reflective criticism, without flinching or suppressing a word. The method of psycho-analysis is thus a sort of mental self-vivisection without chloroform—plainly a thing to be initiated by no rash or untrained hand.

Various starting points may be adopted. The most useful and the most direct is to go back to the first offense the child can remember and ask him to recall all the peculiar circumstances—his position, his surroundings, and particularly his companions, together with his own wants, fancies, grievances, or disappointments, at the time. Sometimes it is necessary to hark back still further and to get the child to relate not his first delinquent action, but his first acquaintance with such actions, as a mere spectator or listener. At times it is more fruitful to start from the last offense, as the one most clearly recollected,<sup>23</sup> and work backwards rather than forwards. But frequently the offenses themselves are best left ignored, and the investigator simply asks whether the child has been happy lately, what his special worries have been, or what are his attitudes to his teachers, schoolfellows, brothers and sisters, and, most of all, to his parents. Usually the more oblique the approach, the better; and the analyst, with all gentleness and caution, tries to feel his way from secondary symptoms and minor clues along the bifurcating paths of mental life, step by step, and stage by stage, back to the origin of the whole affair. More often than not, he simply sets the child chattering about his daily existence—his school, his leisure amusements, his deepest and most exciting interests—keeping him throughout in a vein of self-revelation, only guiding here and there the course his confidences take. All the time, he will be mentally noting, as unobtrusively as may be, not merely the boy's ostensible account, but the gaps and rents in his narrative, his inconsistencies, his little evasions, his

---

<sup>23</sup> Too often teachers and others make this the sole mode of approach. More commonly than not, these recent affairs are precisely those which the child is most ashamed of or most frightened to speak about with candor at the outset.



change of voice and glance and expression, the passing blush, the incriminating pause, the telltale shift in the topic. Occasionally, a joint discussion of the child's dreams and (if he can be got to talk about them) of his fantasies and waking day-dreams may yield the needed key. More rarely, technical devices such as association tests may be introduced to advantage. There is, however, and there can be, no fixed or universal routine, no royal highroad to the hidden ambushes of the mind.

Should any inhibition or resistance be encountered, should the child suddenly cease to be candid and communicative, then the confronting obstacle must itself be first attacked: the main issue must be laid for the moment on one side, and the investigator must seek, either by renewed efforts of tact and sympathy or perhaps by postponing his catechism to a more propitious occasion, to awaken in the child complete trust, confidence and rapport and to overcome the slightest qualm of resentment or suspicion. All through, the prime object is not to lecture or to criticize, but to let the little patient see for himself how his life has developed and how he himself has moved to where he is, so that, with a truer insight into his own besetting impulses, he may be better able to cope with them unaided.<sup>24</sup>

Fortunately, in the criminal child the whole process is usually accomplished with greater speed and with fewer difficulties than in the neurotic adult. The child is less sophisticated and less reserved, and if he can be approached during the naïve, outspoken stage of early youth, the cure may be quick and efficacious. The young are nearer to real beginnings, and their mental processes are less involved. Nor is the criminal so deeply repressed as the genteel; his motives are unformulated, unattended to, unrecognized, rather than genuinely unconscious; his mental operations may be muffled in a fog or screened by their own self-generated smoke, but they are not totally sub-

---

<sup>24</sup> Note that the essential thing is that the child should himself make the discovery; to *tell* the child what his motives were is useless, and to censure those motives worst of all. The facts of causation must be allowed to unclouthe themselves spontaneously before his eyes in the sanctum of his own private consciousness, and he must pass judgment upon them of his own free will.

merged and unlocated, and his very shamelessness may make the whole discussion easier.

Nevertheless, with delinquents the psycho-analytic method brings with it special problems of its own. They lie; they act; they fool;<sup>25</sup> their word has always to be verified; their submission to the treatment and their anxiety to be cured is neither vigorous nor voluntary; and their confidence, particularly when they have always been punished by those in whom they should confide, is hard to capture and difficult to keep. With all but the oldest and the brightest, too, the analyst must pursue a somewhat simpler line than that usually taken with adults; there will, for example, be less talking, less confession, less dissection of dreams and fantasies, more attention to the child's conduct during play, and more observation of his natural responses to test situations both casual and contrived. Happily, with children of school age, the most delicate motives of all—active sexual complexes, in the narrowest sense of the adjective "sexual"—seem comparatively unimportant; with young offenders, as we have seen, the more usual complexes are parental rather than sexual: directly or indirectly, they hinge upon the child's personal relations to other members of his family. Unless, therefore, a child of these tenderer years, by private avowal or by overt act, spontaneously proclaims the presence of some sexual worry, the cautious analyst will be scrupulously chary of trying to probe for its existence. Sexual problems, sexual conflicts, and sexual temptations undoubtedly arise during this so-called "latent" period; but, sometimes because they are less repressed, sometimes because the repression is for the time being more successful, they work less mischief and lead less often to misconduct before the pubertal epoch has drawn near. Hence, during the school period, without some cogent reason for picking up these sensitive issues, the psychologist will,

---

<sup>25</sup> The layman usually cites these characteristics as insuperable impediments to a trustworthy analysis of the young criminal's mind. Such a critic forgets, or has never learned, that the hysterical adult adopts much the same defenses, is a liar, an actor, and a furtive humorist. The real difference, of course, is that the maneuvers of the delinquent are conscious and deliberate, or largely so, and, therefore, as a rule, easier, not harder, to detect and overcome.

as a rule, be wiser if he prefers discretion—if he forgoes the uncertain benefits of a ruthless rummage rather than risk the surer perils that may arise when these turbulent interests are stirred up. After puberty, the case is altered; but the utmost circumspection must ever be preserved.<sup>26</sup>

### 3. *Reëducation*

Often the mere discovery by the child himself of the true reasons for his misconduct is sufficient to effect a cure: to understand one's self is the first stage towards self-control. Directly or indirectly, here as elsewhere, the mere search for causes tends of itself to dissipate them. To find that at last an experienced sympathizer is seeking to study and understand him, is listening to his story in a calm, matter-of-fact, non-shockable way, is, for many a misconstrued youngster, a wonderful encouragement to self-reform.

But usually, for enduring results, something more will be needed. Exploration must be supplemented by training, mental analysis by mental re-synthesis: and the child's whole character must be reëducated. In what does this reëducation consist? Not at all, or hardly at all, in mere verbal instruction—in moral arguments or reiterated ethical precepts. It was a false maxim of Locke that we ought always to reason with the naughty child. Rousseau's counsel was far better: *soyez raisonnable, mais ne*

---

<sup>26</sup> Upon these quasi-psycho-analytic methods the comment contained in the last Home Office Report deserves to be quoted in full: "If it is true, as certain psychological writers have recently said, that the hypothesis of the unconscious motive is one of the greatest discoveries of modern science, a great deal of light may eventually be thrown on the conditions which lead children to commit offenses, and on the right methods of dealing with them. Even if the claims advanced for psycho-analysis as a means of treating juvenile delinquency prove to be extravagant, all who are responsible for the care and training of children must yet acknowledge the renewed stimulus thereby given to the subject of child study which is likely to lead to more enlightened handling of young people by parents, teachers and others" (*loc. cit.*, 1923, p. 12).

I may add that since with children, and especially with young delinquents, the general procedure departs so much from the method which the trained psycho-analyst adopts with a grown-up neurotic patient, it would perhaps be wiser to avoid the term "psycho-analysis," with its somewhat special connotations and to speak rather of psychological analysis or of mental exploration.

*raisonnez point avec votre élève.*<sup>27</sup> Parents, teachers, magistrates, and missionaries, in the wisdom of their hearts, too often follow the British philosopher and think that the one way to convert the sinner is to lecture him—to ply him with long and ceaseless harangues, remonstrative, interrogatory, hortatory, damnatory. It is the method of the Arabian sage at sea, who thought it better to blow hard into the sails than to go behind and take the tiller. Many a child has run away from family or rescue home simply because (to quote my latest customer) he “couldn’t stick being preached at.” Here is the safest motto for the would-be moral tutor: *Leave the child to do the talking.*

The reëducation that I have in mind is not an intellectual one; it must, before all else, be practical. It consists, first, in the arrest of what I have called mental repression, by fostering frankness and candor—frankness and candor of the child with himself as well as towards those about him; secondly, in the provision of the few facts necessary to satisfy the child’s unspoken questions—enlightenment perhaps as to his own parentage or the phenomena of sex; thirdly, and most of all, in the progressive training through self-discipline of his own natural instincts and emotions—in the slow substitution of good habits for bad, of new and loftier outlets for the old and lawless, of more salutary interests for unhealthy interests or no interests at all, of helpful sentiments centered on some benevolent friend instead of harmful sentiments for base companions or hateful sentiments towards those against whom the child has harbored some grudge.

All this is largely a matter of hooks and eyes—of finding suitable openings in the child’s mind and hitching on to them appropriate experiences, activities, and thoughts. One piece of tutorial assistance, however, must not be omitted. Too often the child is never taught how precisely he may defend himself against his own ineradicable cravings. “Tell me,” says the teacher, “why did you steal those sweets?” “Please, teacher, I couldn’t help it.” “Then, will you promise not to do it again?” The child nods an emphatic “Yes,” and there the matter ends. But how is the child to be expected to keep his

---

<sup>27</sup> “Be reasonable yourself; but do not reason with your pupil.” *Emile* (1762), II, p. 80.

pledge, with whatever sincerity given, when already he has implied that he cannot help breaking it? Even the older, well-meaning, and intelligent offender will make the same mistake himself, and trust, when he is dismissed from court or discharged from prison, exclusively to his good intentions to keep his foot from slipping. Never does he form a considered plan how to avoid temptation or how to resist it when encountered; never does he realize that the first thing to do after deciding on a project is not to execute it there and then, but to sit down and draft some practicable scheme for carrying it through. The sound adviser, therefore, will draw from his young client what aims he has in view, how he thinks he can still satisfy his strongest interests without running counter to the law; and, with some well-framed policy of life, will induce him to fortify himself against failure in the future.

#### 4. *The Child's Consciousness of Himself*

By all this process of analysis and reëducation, the sentiment that must chiefly be changed will be the child's own sentiment for himself. Professor McDougall has taught us that "will," or "voluntary control," "proceeds from the idea of the self, and from the sentiment, or organized system of emotions and impulses, centered about that idea."<sup>28</sup> Conduct is not a purely endogenous growth, guided solely by some inner voice of conscience implanted in the human breast. The expanding self-consciousness of the developing child is shaped and illuminated mainly by the reflection of himself that he finds mirrored in the minds and expressions of those about him. The delinquent who has been constantly scolded and rebuked, constantly spoken of in his hearing or to his face as a "naughty boy" or as a "hopeless criminal," soon accepts these oft-instilled suggestions, conceives himself to be in fact what he always has been assured he is, and acts with a will the character assigned him. This picture of himself has now to be repainted. The child has to be shown that his censured conduct is the outcome, not of sheer inherent baseness, but of natural human instincts, of lawful desires un-

---

<sup>28</sup> See *Social Psychology*, Chap. vii, "The Growth of Self-consciousness and of the Self-regarding Sentiment."



lawfully exercised. Neither he nor his tutors need necessarily assume that all wrongdoing should first be eradicated before doing right can ever begin. At home he can still be trusted. At school he can still be given responsibility and praise. Everywhere virtues should be viewed with a magnifying glass, and faults with a blind eye. Should the penitent relapse, let him not feel that all is now lost. Even if arrested and brought to court, he must still be sheltered from public disgrace and shielded from all conditions that might mark and brand him as a criminal in the making. And in the juvenile court room itself, every precaution should be taken that neither the child nor his friends and parents should feel that he is on his trial for crime. Whatever happens in the end, he must come away inspired with hope, not with desperation.

In the most hardened miscreant there is always a better self. Never let him think this better self is dead. Never allow him to evolve the notion that he is, by inbred nature, wicked, sinful, irredeemable, a rebel against home or an outcast from society. Should he have come to such a view, it must be radically altered. He must be taught a wholesome pride and a salutary self-respect, and thus, so far as possible, stirred up to institute his own self-reformation.

##### 5. *The Need for a Sympathetic Confidant*

Sentiments for others, however, must be cultivated as well as the child's own sentiment for himself. The worship of a nobler personality is the greatest power for lifting the worshiper himself nearer to the nobler level; it is the power that has been utilized by all the higher religions of the world. The best object for the young child's love is the most natural one—his father or his mother, and often reform is effected when, by a little outside help, he and his family are truly reconciled and can resume the close affectionate relations which his own delinquencies have ruptured. At times, unhappily, the friend has to be sought outside the home circle: a teacher, a club leader, an older comrade, some voluntary visitor to the house, some probation officer appointed by the court, must step in and act as the child's confidant—as a sort of sympathetic father confessor, like the Padre in *Stalky*.

If the process of psychological analysis becomes long drawn out, it will be the analyst himself on to whom the child's feelings will quickly get projected. The sentiment so formed, like all new attachments to strange personalities, will really be based upon older sentiments. It will spring mainly from a transference of an ancient affection to a fresh friend, of the child's earlier devotion for his best-loved parent to the kindly adviser who now stands (the expression is trite enough, but here singularly apt) *in loco parentis*. For this very reason, the personal influence of the new-found patron, though of late origin, will be deep, powerful, and far-reaching. Indeed, difficulties may even arise when the time comes for the child to be weaned—when the analyst can afford no further time and desires to see his little patient stand alone. The break must not come too suddenly. Once more, recourse may be had to some lay, voluntary guardian, to whom the child may be gently passed on and who may act, in German phrase, as the child's *Fürsorger*, or, as one little French girl put it to me, as her *bon ange*.<sup>29</sup>

#### 6. *The Cultivation of Abstract Sentiments*

The dull and backward, in the development of their sentiments, can never get beyond this concrete personal level. Their knowledge and intelligence are too limited for them ever to acquire more abstract sentiments—a zeal for generalized ideas of virtue. Duty, truth, honor, and the like, are conceptions they can never thoroughly grasp, and therefore can never thoroughly respect or reverence. To try to inculcate such ethical ideals is, with them, sheer loss of labor. With children more intelligent, however, as they grow in years and understanding, it is essential, whenever it is practicable, to lift conduct up from the merely personal plane and set it on the higher plane of abstract moral principle. What lines may profitably be followed, I have already hinted in discussing the treatment of the supernormal.

---

<sup>29</sup> On the suggestive scheme, drawn up for the care of delinquent children in Germany, see the official *Statistik über die Fürsorge-erziehung Minderjähriger (Gesetz vom 2. Juli, 1900)*, Königlich Preussischen Ministerium des Innern, Berlin, 1906.

## CHAPTER XIII

### NEUROSES

*La mauvaise pensée arrive dans mon âme,  
En tous lieux, à toute heure, au forte de mes travaux,  
Et j'ai beau m'épurer dans un rigoureux blâme  
Pour tout ce que le Mal insuffle à mon cerveau.*

*Mon crâne est un cachot plein d'horribles bouffées:  
Le fantôme du crime à travers ma raison  
Y rôde, pénétrant comme un regard de fées.  
Faut-il que ma vertu s'abreuve de poison!*

*J'écoute malgré moi les notes infernales.*

Wicked thoughts come into my soul, in every place, at every hour, in the midst of my work. In vain do I try to purge myself with rigorous self-censure for all that the Spirit of Evil breathes into my brain.

My skull is a cell full of horrible fumes. The ghost of crime prowls across my reason, penetrating like the glance of an evil eye. Surely all my goodness must be soaking itself in poison!

I hear, in spite of every effort, infernal voices.

MAURICE ROLLINAT.<sup>1</sup>

### Nature and Frequency

In many of the delinquent cases marked by moral conflict or repression, not only is the offense itself of a highly irrational cast, but it is coupled with other mental traits, less obtrusive and less troublesome perhaps, but equally morbid and even more eccentric; and the whole picture is at times so clear and characteristic that a definite psycho-neurosis can be diagnosed at once. Not every affection of the nervous system is traceable to emotional factors. What, with some ambiguity, are commonly spoken of as nervous disorders belong to two partly

---

<sup>1</sup> *Les Névroses* (1899), "Le Fantôme du Crime, i, 1-5.

overlapping classes—the organic or physical on the one hand, and the functional or mental on the other. Organic disorders of the nervous system—such as epilepsy and chorea—we have already considered under the heading of physical conditions. It now remains only to discuss those that are predominantly functional or mental. It is these that chiefly spring from, or are chiefly aggravated by, repression or conflict in the recesses of the mind. It is these, therefore, that are of special importance in cases of delinquency.

About 15 per cent of my juvenile cases showed mild neurotic tendencies or minor nervous symptoms of a functional type, and among these a smaller, but still considerable group—nearly 10 per cent of the whole number—suffered from some nameable neurosis.<sup>2</sup> Severe or slight, these neurotic conditions were nearly ten times as common among the delinquent girls as among the delinquent boys (see Table XX, page 540). Considering how many of the delinquents show instability, repression, and the formation of complexes, it is perhaps remarkable that the proportion of neurosis is not higher still. Scarcely one in four of those suffering from repressed complexes are in any noticeable degree neurotic.

Freud, as is well known, has declared that neuroses are the obverse aspects of perversions.<sup>3</sup> In the same way we might regard the perversity of many delinquents as an alternative manifestation to a neurosis. One unhappy child may keep him-

---

<sup>2</sup> A neurosis is here defined as a functional nervous disorder—that is to say, a nervous affection attended by no gross or demonstrable change in the organic structure of the nerves or nervous system. The shorter generic term I use as including what are more correctly named “psycho-neuroses,” as well as what are sometimes distinguished from them as “actual neuroses.” It should be added that the distinction between what I have spoken of as physical and mental disorders respectively is no more than a relative one, due largely to our ignorance of the finer physical changes that produce those subtler symptoms that we are forced to describe in purely mental terms. For a discussion of such nervous states, as occurring among school children, I may refer to my brief article on “The Neurotic School Child,” *Studies in Mental Inefficiency*, IV (1923), i, pp. 7 *et seq.* I hope to treat the subject at greater length in a separate volume, and therefore dismiss it somewhat shortly here.

<sup>3</sup> *Three Contributions to the Theory of Sex* (1920), p. 29.

self from naughtiness at the cost of a nervous collapse; another protects himself from nervous collapse by an outburst of delinquency. In a few both symptoms are conjoined, and the same cause has a twofold consequence.

### Neurasthenia and Anxiety States

Of the various forms of neurosis found among school children some have but an indirect relation to misconduct; others lead to it directly as their chief and most salient symptom. We may glance at the former group first. It includes two main affections, anxiety states and neurasthenia. Both of them, though frequent enough at the school age, have but little to do with tendencies to crime.

Neurasthenia,<sup>4</sup> which differs from most other neuroses in being somewhat commoner among boys, is a disorder characterized by a dull, listless, irresponsive condition, such as makes readily for maladjustment both at school and at home. Occasionally, though not, indeed, with much frequency, some criminal action is the ulterior result. Thus, the lack of will, so often deplored as a feature of unstable delinquents, may sometimes be the sign, not of an innate instinct of submissiveness, but of some neurasthenic or psychasthenic state. Naturally enough, none of the exploits of these truly nervous offenders shows much vigor or great enterprise. If money is left lying about, they may yield limply to the temptation and employ the stolen coins in buying for their jaded minds some pleasure to soothe or stimulate. But an elaborate theft they seldom plan, and they rarely have pluck enough for a spirited adventure.

Among the delinquent children, as among the non-delinquent, the neuroses that are by far the most prevalent consist of what may be termed anxiety states. In these disturbances, whether

---

<sup>4</sup> I use the term in its strict and narrow sense to denote a primary fatigue neurosis—that is to say, a functional nervous disorder which is not merely an incidental after-effect of some previous illness, but is itself apparently fundamental and is essentially distinguished by unusual susceptibility to fatigue. In view of the theories connecting many forms both of neurosis and of delinquency with sexual irregularity, it is suggestive to note that nearly all the neurasthenic offenders that have come before me have had a history of sexual self-abuse.



the precise disorder be an anxiety hysteria or an anxiety neurosis or (what is more usual) the two combined, the dominating mood is one of fear. Nor is it surprising to discover that the commonest crime among these little sufferers is truancy or flight from home. Care, however, is needed in the diagnosis, for the nervousness may be the after-effect, not the antecedent cause, of the child's wrongdoing.

The second group of neurotic conditions, rare in their extreme and typical form, calls for consideration at somewhat greater length, since the symptoms are far more intimately associated with childish faults. It is a mixed cluster of mild disorders, variously described under the title of obsession neurosis or compulsion hysteria. For our present purpose it will be convenient to distinguish two chief kinds, the one characterized by obsessive thoughts and the other by compulsive acts. It will be found, as their nature is examined, that both are but extreme examples of a so-called complex-symptom carried to an extravagant and specialized length.

### *Obsessive Thoughts*

We have already remarked in considering mental imagery how certain visualized pictures, certain memories, phrases, and thoughts may recur time after time to the young child's consciousness, usurping his mind and fixing his attention until at last he seems impelled to respond: he either puts the besetting ideas forthwith into action or escapes from their insistence by plunging into some counter-activity, wild, venturesome, or criminal. The customary account of the process we were led to call in question. It seemed doubtful whether the sheer vividness of the child's imagination—his exceptional clearness of inward vision, his unusual power of mental hearing—could be the sole cause of such obsessions. Those who have urged the importance of obsessive imagery as an indirect determinant of crime never explain why the imagery itself is obsessive. The normal adult is usually able to dismiss his fancies, however engrossing, whenever he so desires; he can, at all events, resist the inclination to put them into actual practice. What is it, then, that numbs and paralyzes the will of the neurotic child?

A clue to this curious state is found in complaints and expressions dropped from time to time by the more intelligent. Such a child will not infrequently ascribe the irrepressible thought to some independent agency, which he fails or refuses to recognize as a portion of his own mind. "I could see that necklace," says one little thief, "every time I shut my eyes, just as though the Devil kept pushing it under my nose." "I could see her," says an older boy of a young seducer, "as clearly as if she was in the room, beckoning; she kept coming and 'willing' me, and I had to go and join her." "I heard them swear-words," says a third, "as plain as if father were there, shouting them over and over again; and at last I said 'Oh, shut up!'"—an ejaculation the boy's astounded mother recalled and verified. Such are the comparisons they make. Each child is speaking of his own mental imagery, but the imagery is described as rising and thrusting itself upon his notice irrespective of his will.

Incongruities like these imply some cleavage, some disjunction in the mind. Such a bifid personality, as we have seen, is a regular result of a past or present conflict. Nearly always, in the last resort, the dislocated mental fragment, the powerful but repudiated tendency which thus keeps shooting up like a Jack-in-the-box on a spring, is the product, direct or indirect, of an instinct. It is not the girl "willing" the boy, but his own biological nature driving him—a nature which has nothing to do with his previous interests or his training or intentions, a nature which is as foreign to his wishes as it is new to his experience, a nature therefore which he readily concludes must belong to "something not himself." The inference is plain. What keeps these mental images so bright and so persistent is not the sheer capacity for imagery as such, but some pent-up emotional impulse that has been awakened by, or has become attached to, the thoughts or recollections that the images represent. The recurrent images, in fact, are offshoots of some active complex, dissociated, as the phrase is, from the main personality. Thus, in most cases, perhaps in all, it is the obsession that produces the imagery, not the imagery that produces the obsession.

*Compulsive Actions*

Petty compulsive actions are by no means uncommon in young boys. The child suffers from an uncontrollable impulse to make certain irrational movements—to count everything he comes across (like Napoleon), to touch certain posts or articles of furniture (like Dr. Johnson), to utter the most immodest words at the most unseasonable moments (like John Bunyan). At times the impulse may be a criminal one. Kleptomania, nymphomania, pyromania, dipsomania, dromomania, homicidal mania, in short, nearly all the so-called criminal “manias,”<sup>5</sup> prove to be examples, whenever the suffix has any justification at all, of a compulsion neurosis. The offender acts as if under some spell of magic, and feels himself forced irresistibly to perpetrate some useless theft, to wander off on some motiveless tour, to set light to some gloriously inflammable pile, or even to stab his nearest relative or strangle his dearest friend. He is dragged on by the same blind, unreasoning fascination that will sometimes seize a nervous adult reeling at the edge of a high sea cliff or leaning on a low and lonely parapet above a dark and soundless stream. The thoughts, or whatever inspires

---

<sup>5</sup> Outside the asylum the diagnosis of “manias” had better be abolished. Like so much criminological jargon, these pseudo-scientific terms profess to give a condensed interpretation, while supplying no more than a high-sounding descriptive title in barbaric Greek. Their danger is that they seem to the layman to finish the matter with a word and so to dispense with all need for closer scrutiny. On the lips of the unpsychological—whether journalists, teachers, doctors, or police—kleptomania covers all tendencies to repeated and irrational theft, the theft appearing irrational either because, in the view of the logical onlooker, the articles stolen could not have been needed or because the pleasure of their enjoyment is wholly outweighed by the pain of inevitable punishment. Irrationality such as this, however, points not to a mania but simply to an emotion. Cases of apparent “pathological stealing” (to adopt a safe translation of the pseudo-scientific phrase) may be due to one or more of an innumerable list of causes—to feeble-mindedness, to substitutional compulsions, to instincts of hunger, hunting, and acquisitiveness, all as strong as they are blind, or else to the sheer impetus of habit.

It should be added that obsessions and compulsions are also found as symptoms of psychoses; indeed, severer cases of compulsion neurosis were formerly classed as “impulsive insanity.” In children and young persons, however, as we shall see in a moment, a psychosis, though often feared, is hardly ever found (see page 569).

them, seem to seize hold of his very body and limbs; he moves, like a sonnambulist, like one possessed or hypnotized, in a state of dreamy confusion, a state which he can only explain when all is over by saying he "was not himself" or was "beside himself" for the time being, that he "never meant to do it," that he "could not help doing it," that "something made him do it." And those who know him best will fully agree that the act was altogether out of keeping with the general tenor of his conduct. Having committed the crime, he may make no normal effort to escape detection; he may, with true remorse and of his own free will, at once plead guilty; he may even, in rare and dubious instances, appear genuinely to have forgotten all about it.

The victims of obsessive thoughts are usually children of an unstable temperament and of a repressed, neurotic type. The victims of compulsive acts are so, almost without exception. They are boys more often than girls, quick more often than dull. Outwardly they may seem bashful and sensitive; inwardly they nurse an assertive, aggressive, and even domineering disposition. As a rule, there is a history of minor nervous troubles in the past—sleepwalking, sleeptalking, incontinence, or constant and causeless headaches. The few girls who yield to such compulsions have, in my experience, been, for the most part, semi-hysterical personages near the time of puberty, and the act itself is not infrequently committed during (or just before, or just after) the climax of the monthly cycle.

Once more, a very little exploration is ordinarily enough to show that the root of the trouble is some secret mental conflict and that the compulsive habit has developed as a substitutive or symbolic outgrowth. Generally, the intrinsic strangeness of the action betrays its non-rational origin and suggests the unconscious and automatic working of some accidental and illogical association. The boy steals, as in the case described above,<sup>6</sup> nothing but spectacles, or he shows, as in another case, what his teacher terms "a monomania for other people's gloves." The instances most easily analyzed and most readily understood take the form of so-called fetishistic stealing already alluded

---

<sup>6</sup> Martin G. (Chapter IV, page 175).

to: one neurotic youth, for example, instead of assaulting a young girl lodging in the same house, was incessantly stealing her ribbons and underwear, and was eventually brought to me for stealing her vanity bag, which contained, not only her money (which he did not want), but also her powder and cosmetics (which, through some odd inquisitive whim, he did). In children of school age the association is seldom so obvious and direct, and the mental mechanism at work is much the same as that just described in discussing the obsession of ideas.

Though the presence of a mental conflict is, as a rule, not difficult to demonstrate, its exact nature and its ultimate origin is often too involved to trace out with completeness.<sup>7</sup> In well-marked cases of compulsion neurosis one feature continually brings disappointment. No sooner has the first obsession been cured than a second takes its place, and more than one case has come before me where the compulsive stealing proved quickly curable, but some nervous habit, hardly less disquieting, supervened almost immediately—a tic, a spasmodic squint, a trick of chewing rags, or (as with one of my neurotic boys) a passion for constantly flinging open every door and window in the house.

### Hysteria

Of all forms of psycho-neurosis, hysteria is the most notorious. But among delinquents of school age, hysteria, properly so called, is far rarer than is generally supposed. Even among adolescent cases, the type of girl who so easily gets herself labeled “hysterical” proves to be suffering merely from high emotional excitability, partly constitutional, partly due to pubertal instability—not repressed (as in the true hysteric) but unsubdued and unrestrained, and the distinctive marks of true hysteria are slight or non-existent.

Hysteria, in its typical form, “the old hysterical mock-disease,”<sup>8</sup> is characterized more by physical manifestations than

---

<sup>7</sup> To describe at length any illustrative cases would require too much space and involve too many technicalities for a book of this description. Two suggestive instances are related in Healy's *Mental Conflicts and Misconduct*, Chap. vi, “Conflicts Causing Impelling Ideas.”

<sup>8</sup> A precise and pregnant phrase of Tennyson's (*Maud*, XXVIII, iii.).



by mental. And to avoid all ambiguity recent writers have preferred some longer and more technical title—as conversion hysteria (suggested by Freud) or substitution neurosis (suggested by Rivers). As such a nomenclature conveys, the superficial symptoms—the paralysees, contractures, anæsthesias, and the rest—appear as *substitutes* for the underlying emotional tension, the mental trouble, by the processes of association and habit, being *converted* into the physical. The child, for example, may appear to suffer from deafness, from blindness in one eye, or from a paralyzed arm or leg. No organic basis for the defect is discoverable: usually, indeed, he has an air of health and happiness quite out of keeping with his complaint. The only causative disturbance to be found is a disturbance of the mind. As a rule, he is of an egocentric temperament, and this of itself may lead to jarring demonstrations and importunate displays, such as make him most tiresome for his family and friends to wrestle with. At the same time, the physical defect is suspiciously well adapted to attract the notice he craves and to obviate the duties he detests. When, in addition, the young patient is known to be deceitful and dishonest, parent and doctor alike infer, not unnaturally, that the child is merely malingering. An unwitting malingerer he frequently is; nor is the line easy to draw, least of all in dealing with delinquents, between what is a deliberate hoax and what is unconscious simulation. More often than not the young *malade imaginaire* sincerely believes his disability real; he suffers from self-suggestion; and, indeed, from his general attitude of mind, he often proves to be suggestible and credulous in more than one direction.

Let me give, as a final instance, one of these hysterical cases. A little girl of nine named Flora<sup>9</sup> was sent to me by her head

---

<sup>9</sup> Flora S. Age: 9½. *Family History and Home Circumstances:* The home was fairly clean and comfortable. The father, a breezy policeman, was said to be a heavy drinker. The mother, emotional and overwrought, with lines of temper about her eyes and mouth, was plainly remiss in household management and capricious in matters of discipline. Five children, Nellie being the youngest girl; one younger brother—all being of a bright, imaginative, precocious type.

*Physical History and Condition:* Born at 8 months: "ailing and

mistress on account of her meddlesome and mischievous conduct in the classroom, culminating in petty theft. It was thought at first she might be epileptic. The girl's own brother, a child of six, had suffered from mild and diminishing seizures of an epileptiform type, ascribed to meningitis. And on the mother's side there was a family history strongly suggestive of an epileptic inheritance. The mother's father, after a blow on the head at the age of thirty, had become subject to sudden fits. The mother's aunt had died demented. The mother's sister was feeble-minded and prone to violent paroxysms of rage. The mother herself, though healthy enough, was of a fussy, irritable, over-anxious disposition, scolding her lively youngsters in falsetto screams, and forever wagging a hortatory finger.

Flora was a happy, captivating child, with golden curls, a sunny smile, and an arch affectation of babyish simplicity. Like

---

sniffing a little" during the first few weeks: 6 months late in walking and talking. Broncho-pneumonia at 4, measles at 6, with delirium in both attacks; palpitation and one or two fainting attacks reported between the ages of 7 and 8. Physical health and strength now normal, but several more or less imaginary ailments complained of (see text). Height, 118.0 cm.; weight, 23.0 kg. (about the average of a London girl of 8½). Upper central incisor teeth peg-shaped and slightly notched; striated scars at the angles of the mouth: (parents refuse to take the child to hospital for blood test). Slight migrainous headaches. Kneejerks hard to elicit, but well marked: palatal, conjunctival, and other reflexes somewhat diminished. Areas of temporary numbness on the inner surfaces of the forearm. Visual fields somewhat restricted.

*Intelligence:* Mental age 8.7—with marked scattering of failures in the Binet-Simon tests. Suggestibility and visual imagery well marked. Memory weak.

*Educational Attainments:* Spelling and Reading, 8.5. Arithmetic, 7.3. Drawing, 7.0 (her attempts at the human figure show the comical, babyish representations so characteristic of hysterical children). Other subjects, about 9.0.

*Temperament:* Innate instability (possibly in part enhanced by organic instability of the nervous system due to inheritance and infection). And, superinduced on this as a foundation, a mild conversion hysteria, with sexual and parental complexes.

Uneven emotional development; sexual precocity, combined with regression to—or fixation at—a comparatively infantile attitude in regard to many social points: (deep unsatisfied demands for demonstrative affection; plays usually with tinier children; talks to her dolls, takes the cat to bed. See also text).

many hysterical children, she spoke with quick, high-pitched accents, and had a shrill little laugh, like the squeak of her own slate pencil making flourishes. Her features were pretty and she manifestly knew it. But about her lips and teeth she bore the stigmata, faint but indisputable, of congenital syphilis. Long ago, influenced by what he knew of her infected state, the family physician had foretold that she too would develop fits before she had left infancy behind her: this grim prediction, however, had gone unfulfilled; nor had she, even while her teeth were cutting through, succumbed to the convulsive attacks so common at that crisis. In build she was slight and undersized, but there was a rosy plumpness in her face that the psychologist views with more suspicion than the doctor. Mentally she was a little below average, and in arithmetic extremely backward; she betrayed, too, in many of the tests, the peculiar defects of memory that epileptics are sometimes said to show.

The nature of her thefts was somewhat singular. She stole all sorts of articles in all sorts of ways, openly, furtively, stupidly, resourcefully. The money, however, she never spent on sweets or toys; the brooches, bangles, and books she never pawned or sold. They simply disappeared. From time to time they were rediscovered, dropped in the most unlikely hiding places. She would even lock away her own belongings and then forget where she had put them. There was, for example, a favorite Teddy bear, missed for three weeks and at last accidentally found by the mother, rammed beneath some undarned stockings in the mother's own workbasket. Of each of these pranks all memory seemed to vanish, as if brushed clean away with a sponge. After one of the more erratic of her early thefts, she was again medically examined; the family physician now declared that she must be suffering from "epileptic equivalents," and at length recommended her for an institution as a case incurable.<sup>10</sup>

---

<sup>10</sup> At this time a neighbor had reported that the child suddenly seemed to lose herself, turning for a moment very pale and almost looking as though she was likely to fall. This doubtless suggested the presence of *petit mal*; but a more careful examination showed that the fainting attacks were due to a slight weakness of the heart, left by measles, but outgrown by the time she came to me.

Let us look into Flora's temperament more closely. The first thing to strike an observant eye is her excitable manner and self-centered talk and conduct, all strongly indicative of an ingrained hysterical nature. Her demeanor is an incongruous compound of the spoilt baby and the demure coquette. Her games are those of a child of six—played chiefly with rag dolls and a miniature tea set of tin. Yet she is eager to allure the attention of adults and invents extravagant stories from a thirst for notoriety. Throughout every interview she chatters volubly, twisting the conversation just as she desires. Not for an instant can she stand still; while she talks she tugs continually at her garter—a common trick of the restive child; and on the least excuse she skips across the room, prying and peering into every drawer and cupboard, like the officious busybody that she is. In nearly all the tests she shows herself highly suggestible, eking out her recollection of the simplest test picture with innumerable fantastic items.<sup>11</sup> Her suggestibility is easily confirmed by attempting light hypnosis. Told to gaze for a few seconds at a tiny mirror, she at once drops her talkativeness and fidgetiness; becomes limp, drowsy, and calm; and without further injunction closes her eyes and lapses into an almost cataleptic trance—an unanticipated sequel in a child so young and irrepressible.

In one of these hypnoidal states she was asked to turn in memory to her latest escapade, the theft and concealment of a box of blouses taken from her teacher's desk. She could always "make pictures in her brain," and found no difficulty in fancying herself seated again in the classroom. She pointed to imaginary furniture—chairs, tables, blackboards; and then paused. I inquired what she was thinking. At once she replied, with finger, outstretched, "I am wondering if there are oranges in that big box." Asked what she was going to do with the box, she answered: "Take it home and see." "What are you doing now?" "I am going across the playground, out

---

<sup>11</sup> In certain tests she showed curious automatisms and stereotyped reactions. Counting backwards, she says—"14, 13, 12, 10, 11—oh my! 11, my 10, my 9, my 8 . . ." etc., counting unnecessarily with her fingers all the time. Asked "How much is 3 and 4?" she says, "5—oh *no*, 2"

by the back gate, with the box under my arm." And so, quite realistically, with her eyes still shut, making graphic gestures with her hands and muttered comments to herself upon her movements and intentions, she indicated that she went first along F—— Road, and then down S—— Alley, and so, through a labyrinth of well-remembered streets, until she arrived at the house of another school friend. Eventually, the whole episode was pieced together, incident by incident, half dramatized, half told. Jointly she and the other girl inspected the contents of the box, and saw, with a shock of disappointment, no oranges, "only silly clothes." Presently she finds herself tripping off once more with the box held under her elbow. Then the thought jumps into her mind that she cannot arrive home with stolen property. So she dawdles on, reaching at last an open space with a fence. There is a hole in the fence. She creeps through the hole. But now she finds a wall in front of her. She stops, stands on tiptoe, and over the coping she flings the incriminating parcel.

Being roused, she remembered little or nothing of the scene she had thus reënacted. She thought she "must have been dreaming." But each detail of the "dream" that could afterwards be verified was found true to the circumstances both of the day and of the places to which she had referred.

Flora's high suggestibility showed itself in other ways. She was fussy about petty ailments, and apt to complain of certain affections in her limbs which certainly had no organic origin. She had heard of a neighbor whose arm had become paralyzed. Surely enough, Flora's own arm became presently numb and powerless, but with a little counter-suggestion its disablement disappeared during the course of an hour or so in a way no real paralysis could ever do.

This, together with one or two minor symptoms of the usual type,<sup>12</sup> was conclusive of hysteria. Hysterical troubles of such a kind are not uncommon in over-sexed girls, particularly towards adolescence. Flora was only nine. Yet, though at home she posed as a wistful little innocent, to the watchful stranger

---

<sup>12</sup> See footnote 9, page 563.



she gave clear tokens of unmistakable precocity.<sup>13</sup> Her mother, therefore, was discreetly warned of the likelihood of undesirable propensities and interests; she, however—somewhat unfortunately as the sequel showed—considered Flora “much too young for ideas of that sort.” But scarcely a week had elapsed from my first interview before I was informed that there had been an outcry in her home because of some immodest little intrigue of the very sort that had been feared; and the next time Flora came to see me she poured forth a long and secret history of petty misbehavior of a flagrantly sexual kind, tricks and malpractices first instigated by her favorite brother and subsequently resumed half innocently with another older boy.

With this final incident as a starting point, a short mental analysis was made. It led quicky to the discovery that the child had cherished, silently and indeed almost unawares, a violent enmity towards her father, which had grown out of an equally violent affection for him in the past; the affection had been transferred, first to the favored brother, and then, on his departure for the Navy, to one or two unruly boy friends. In Flora's loose, illogical mind, thwarted love, sexual aggressiveness, and mischievous and mysterious stealing were all confusedly connected. Her first theft had been the theft of her father's fountain pen. She once said to me, “I wish my Daddy would love me like he loves my Mummy,” and the rest of her antics came about as though in some mute, inarticulate fashion she were thinking to herself: “He won't notice me; he thinks only of my mother, and he writes to her: so I'll punish him by hiding his wonderful pen. Then he'll have to come to me: and I shall find it for him, and he'll love me in return.” It was significant that when her love was shifted to her brother, she started stealing toys from him; and a further link in the net-

---

<sup>13</sup> Apart from her general appearance and deportment, some of her remarks were suggestive. Asked “What is a kitten?” (one of a series of “definition tests”), she replied, with an air of worldly wisdom: “The mother cat takes it out of her body, and it has no fur on, and can't see; then gradually it opens its eyes.” Describing another episode, she mentioned incidentally how she had stripped off her frock in the street to show a boy where she had been vaccinated.

work of unconscious motives was the little fact that the brother she so fondly idolized was himself, at the time of her infatuation, in the habit of filching food from the pantry.

After the analysis, Flora was sent away from her family to a quiet household in the country, and since her return, in spite of the somewhat unfavorable home circumstances, no further trouble has been reported.

### Psychopathic Cases

Insanity, and cases bordering on insanity, I have left until the last, not, as the reader may have fancied, because of the frequency or gravity of such conditions as found in a study of delinquency, but because of their rarity and relative unimportance.

In the whole of the group here studied only one instance was found of grave psychosis—a girl of sixteen suffering from *dementia præcox*. Absolute insanity, of whatever form, is all but non-existent among the young, and therefore need here be no further discussed.<sup>14</sup>

Insanity, however, like mental deficiency, merges into normality by insensible degrees.<sup>15</sup> The borderline personalities who stand between a condition of perfect sanity on the one hand, and definite and definable psychosis on the other, may be termed psychopathic. They comprise individuals who are, as a rule, temperamentally unstable by birth or by heredity and, in addition, show some approaches to or beginnings of insanity, but

---

<sup>14</sup> Of Healy's cases, as many as 5.7 per cent showed major psychoses (including paranoia, juvenile paresis, *dementia præcox*, and manic-depressive insanity: see *loc. cit.*, p. 132). His group was older than my own and consisted mainly of repeated offenders, but even so the percentage seems high for any unselected series of delinquents. Once more, one is led to wonder whether some suspicion of a pathological state was not the special reason for referring these cases to his clinic. So far as my limited experience of the older habitual criminal provides any basis for a conclusion, I am led to believe that major psychoses play a smaller part in England than foreign statistics and foreign writings have led British writers to assume.

<sup>15</sup> The line of demarcation is certainly sharper in the case of insanity than in the case of mental deficiency, but it is still a very rough and arbitrary one—a blur, in fact, rather than a line.

insanity of a type so mild, so mingled, and so transitory that it cannot be classed under any recognized specific form. A few of these cases show anatomical stigmata, and thus in some ways closely coincide with the group that it was once the fashion to call mentally degenerate. A creature of this type commonly looks what he is—

A fellow by the hand of Nature marked,  
Quoted and signed to do a deed of shame.<sup>16</sup>

I personally have classed a child under the heading of psychopathic only if he shows pathological as well as abnormal symptoms—slight delusional tendencies, slight manic-depressive tendencies, or something of the morbid negativism of *dementia præcox*. Barely 2 per cent of my cases were psychopathic in this sense, and the mental trouble bore but an indirect relation to their criminality. Each of these cases has now been under observation for several years, and three have since become certifiably insane.<sup>17</sup>

---

<sup>16</sup> *King John*, IV, ii, 221-2.

<sup>17</sup> During the last few years, in American publications on criminal psychology, the word "psychopathic" has appeared with almost the same profusion as formerly the word "defective." Sometimes the epithet is stretched to cover almost all abnormal mental conditions that are classifiable neither as insanity on the one hand, nor as intellectual dullness or deficiency on the other. It thus embraces not only the neurotic and psycho-neurotic, but also practically all that I should term "temperamentally defective" or "unstable," whether the instability is merely an extreme deviation of a normal function, or also includes some mild amount of definitely pathological disturbance. Dr. Spaulding, for example (*An Experimental Study of Psychopathic Women*, 1923, pp. 2-3), wishes to reserve the expression "defective delinquent" for those who are intellectually defective alone, and appears to use the name "psychopathic" for every case where "the problem is primarily one of conduct deviation rather than one of mental disease." Dr. Mateer uses the term "psychopathic," quite frankly, as synonymous with unstable (*The Unstable Child: An Interpretation of Psychopathy as a Source of Unbalanced Behavior*, 1924). Similarly, Dr. Goddard, adopting the same wide connotation, declares that as many as 30 per cent of his delinquent cases at Ohio are "psychopathic" in this sense (*Juvenile Delinquency*, p. 54). In the ears of the layman some technical appellation of this sort seems certainly impressive and is so far useful that it turns his attention from actions to mental state. Yet the compound word "psychopathic," by its very etymology, implies, and has long been given, a signification far more restricted. The term, together with its employ-

Thus, as we have noted throughout this study, cases of mental subnormality so extreme or so morbid as to be definitely pathological are, among juvenile delinquents, exceedingly rare. Although it was these extreme and morbid cases that first stirred the attention of the public to the need for psychological investigation, their occasional occurrence should not lead the layman or the expert to overemphasize their frequency or to declare their presence upon slight and slender grounds. The intellectually defective and the temperamentally defective, the psychotic and the neurotic, together barely account for one delinquent case in five. Most of the mental troubles are of a milder degree, and the offender, when in any way mentally subnormal (and, after all, he ordinarily is), proves, as a rule, to be no more than dull, backward, or unstable.

## Treatment

### 1. *A Special Institution*

Rare as they are, these neurotic and psychopathic cases are of all classes of juvenile offenders the most difficult to deal with. They cannot be certified as insane, though some would certify them as moral imbeciles.<sup>18</sup> Confined in a prison, reformatory, or Borstal institution, they interfere profoundly with daily discipline and orderly routine, and their own mental state is almost always aggravated rather than improved by a strict, rigorous, and inflexible regimen. It is they who are the chief occasion for the perennial disputes about legal responsibility. It will be they, let us hope, who will provide a convincing ground for establishing a special institution for the unstable offender.

---

ment in this specialized sense, was primarily German, not American (see Koch, *Die Psychopathischen Minderwertigkeiten*, 1891; Stelzner, *Die Psychopathische Konstitutionen und Ihre Sociologische Bedeutung*, 1910), and was introduced to suggest a difference of quality as well as of degree, a morbid derangement not a mere deviation towards an extreme. To avoid confusion, several American writers—for example, Adolf Meyer and Healy—prefer to use the broader phrase “constitutional inferiority”: those, however, among these latter writers who again make the cardinal difference a “lack of functional mental balance” seem still to be speaking of the wider group of the “unstable.”

<sup>18</sup> Dr. Tredgold appears to have inclined to this course, at any rate in regard to cases of compulsion neurosis (*Practitioner, loc. cit. sup.*, p. 51).

The ideal institution, could there be such a thing, would be planned on the lines of a mental hospital. Removal from home is nearly always essential. But the ordinary mental hospital as at present existing is not fitted to their reception. Such advantages as it offers for slight, acute, or temporary cases are unsuited to the prolonged and specialized treatment which the neurotic and psychopathic so often require; nor do any facilities obtain there for the industrial training and occupation which must form an integral element in the treatment itself.<sup>19</sup> For the mildest cases of all, the better course would be, not to mass them together in a single establishment, but to board them out with trained and experienced foster parents, whenever such can be found. An ex-hospital nurse working under the general guidance of a medical specialist can achieve miracles if she has but one or two selected cases in her charge.

## 2. *Psycho-Therapy*

The preliminary diagnosis and the general planning of the treatment should always be in the hands of a qualified expert. Where there is no court specialist, the out-patient department of a hospital for nervous diseases will usually tender the needful advice. Incipient mental disease is often curable. Most neurotic cases can be much improved, and many psychopathic cases can be saved from insanity. But early detection and prompt measures are essential. To unravel the complications of the patient's mind is infinitely simpler, if the task is started before his spiritual tangle has tightened to a knot. The shock of arrest, trial, and confinement, added to the horrors of conscious guilt and the revolt against an uncomprehending repression, too often completes his final collapse. Diagnosis during childhood may deliver him from all this—from punishment, per-

---

<sup>19</sup> It may be pointed out that at present no authority (except the Poor Law Guardians who can deal with such persons only as paupers) has power to spend money on their treatment, and voluntary agencies are without the means. Of course, to provide institutions without also providing machinery for the systematic investigation of such cases would be worse than useless. Except for persons charged with serious crime or remanded to a prison or workhouse, no medical or psychological examinations are likely to be made. Many of the cases are adolescents, and most of them are above school age and too old for the remand home.



haps from crime, and most of all from himself. As we have seen, there is between the neurotic and the normal no sharp cleavage, and in borderline cases much may be done at the early stages by teacher, friend, or parent, following the lines already prescribed for dealing with mental conflicts generally. For treating the older and more serious cases, the chief and most effective, though by no means the sole or exclusive method, is psycho-analysis. But it cannot be too strongly affirmed that psycho-analysis should be undertaken by none but the specially trained and equipped.<sup>20</sup>

---

<sup>20</sup> To Dr. Ernest Jones's compact and lucid little volume, *The Treatment of the Neuroses* (Baillière, Tindall & Cox, 1923), the medical reader may be usefully referred for the general subject with which it has to do. Of less technical works on the psychopathic offender, those of Spaulding and Mateer cited above are the most recent and perhaps the best.

## CHAPTER XIV

### CONCLUSION

*Manfred.* I would spare thyself  
All further colloquy. And so—farewell.

[*Exit Manfred.*]

*Abbot.* This should have been a noble creature: he  
Hath all the energy which would have made  
A goodly frame of glorious elements,  
Had they been wisely mingled; as it is,  
It is an awful chaos—light and darkness—  
And mind and dust—and passions and pure thoughts,  
Mix'd, and contending without end or order,  
All dormant or destructive; he will perish,  
And yet he must not; I will try once more:  
For such are worth redemption; and my duty  
Is to dare all things for a righteous end.  
I'll follow him—but cautiously, though surely.

[*Exit Abbot.*]

BYRON.<sup>1</sup>

I HAVE now worked through the whole list of characteristics discovered or discoverable in delinquents such as those we have been studying. I have taken each point in order, noting its frequency, describing its effects, and indicating how best it may be treated and eased. Nothing remains except briefly to summarize the whole review.

### Causation

Is there, we may ask in conclusion, any all-pervading principle, whether of causation or of treatment, deducible from our detailed discussions?

### *Multiplicity of Contributory Factors*

When we glance back through page after page and turn in succession to table after table, one striking fact leaps out in

---

<sup>1</sup> *Manfred*, III, i, *ad. fin.*

bold relief—the fact of multiple determination. Crime is assignable to no single universal source, nor yet to two or three: it springs from a wide variety, and usually from a multiplicity, of alternative and converging influences. So violent a reaction, as may easily be conceived, is almost everywhere the outcome of a concurrence of subversive factors: it needs many coats of pitch to paint a thing thoroughly black. The nature of these factors and of their varying combinations differ greatly from one individual to another, and juvenile offenders, as is amply clear, are far from constituting a homogeneous class.

Hitherto, the fund of possible explanations invoked by the criminologist has been much too narrow. Ordinarily he is content to trace delinquency in the young to but four or five all-powerful causes—sometimes, indeed, to no more than one. Drink, epilepsy, heredity, or some common characteristic of a city life is seized upon in isolation and made accountable for all. With the same exclusive emphasis, some solitary panacea has been correspondingly put forward. It is as if one should explain the Amazon in its flood by pointing to a rivulet in the distant Andes which, as the tributary that is farthest from the final outflow, has the honor of being called the source. Dry up the rill, and the river still flows on. Its tributaries are countless, though all stream into one sea.

Crime, no less, is the outcome of many confluents. How wide a variety of adverse causes may contribute to youthful delinquency is graphically shown by the figures I have already given. In all more than 170 distinct conditions have been encountered, every one of them conducive to childish misconduct.

#### *Variety of Major Factors*

Yet, in any given case, amid all the tangle of accessory factors, some single circumstance not infrequently stands out as the most prominent or the most influential.<sup>2</sup> Often, as we have

---

<sup>2</sup> This seems to have been the experience of other investigators; see, e.g., Healy, *The Individual Delinquent*, p. 162. We ourselves started with a fourfold classification of factors: (1) the principal or most conspicuous influence (if any); (2) the chief cooperating factor or factors; (3) minor predisposing or aggravating conditions; (4) conditions present but apparently inoperative. This subdivision, however, proved too

seen, it can be definitely established that the child in question showed no delinquent tendencies until the year of some unfortunate event. An illness, a new demoralizing friendship, the death or the remarriage of a parent, the emergence within the growing child himself of some fresh interest or instinct—some dated crisis of this kind has often ascertainably preceded, and perhaps has plainly precipitated, his first violation of the law. At times, and with the same abruptness, so soon as the untoward condition has been removed, his perversity has diminished and his outbreaks have ceased. In other instances, some salient quality of the child's own mind, existing from birth or inherited from his parents, goes far to explain his misconduct—a strong sex instinct, a weak and suggestible temper, or a general deficiency of common sense. In many cases, however, to look for one paramount influence is a more doubtful and precarious business; and to sift causative conditions into major and minor may be little more than an arbitrary assortment, based, it is true, on long inquiries and on many consultations, but of value only for a rough and summary review. If we restrict our reckoning to the main, predominating factors, thus singled out wherever possible, we are still confronted with a long catalogue of causes, each making straight for lawless conduct: and we may still count up as many as seventy different conditions, each forming, in one instance or another, the principal reason for some child's offense.

Table XXII gives my final summary.<sup>3</sup> Major factors seemed discernible in about 96 per cent of the cases, leaving only 4 per cent (fewer still among the girls) with the major factor undetected or unassigned. In addition, subordinate factors<sup>4</sup>

---

elaborate for so small an array of cases, and for the present preliminary account, it has seemed advisable to reduce the classification to the simpler twofold distinction as above described.

<sup>3</sup> The figures are shown in the form of percentages and indicate the number of times the item specified was observed per hundred cases.

<sup>4</sup> Many of these are, of course, but aspects or consequences of other factors; thus, the death of the father may lead to poverty, weak discipline, remarriage of the mother, and a "stepfather complex" (itself with two or three distinguishable components)—all separately enumerated in the tables.

were recorded about 850 times per hundred cases—rather more with the girls, rather less with the boys. On an average, therefore, each delinquent child is the product of nine or ten subversive circumstances, one as a rule preponderating and all conspiring to draw him into crime.

The types of condition noted, however, are far from peculiar to delinquent families. The same circumstances were observed in the non-delinquent cases nearly 330 times per cent—that is, about three per case instead of nine or ten. Thus, with children of the same social class, identical conditions may coexist without plunging them into a criminal career. It must, therefore, as a rule, be either the number of factors or the particular combination of them that renders delinquency a probable result.

I have, partly for purposes of exposition, grouped this multitude of causal influences under a dozen or more main heads. These headings are set out in the table overleaf. The number of individual cases showing influences of each type or class have already been given in Table III.<sup>5</sup> If we mark down the dominant factor in each instance, then, in accordance with this grouping, it becomes possible to classify delinquent individuals into corresponding causal categories. Such a classification—crude and approximate, as it must be, like all attempts to pigeonhole unique individual souls under a few psychological patterns—is, as I have tried to show, of great suggestiveness for treatment.

#### *The Relative Importance of Congenital and Non-Congenital Factors*

Among the many problems of causation, one is fundamental. What, in the production of juvenile crime, is the relative importance of heredity and of environment, or, more precisely, of inborn or congenital factors, on the one hand, and post-natal influences on the other? The issue is an old one. It is of far more than purely speculative interest. Hereditary factors are, from their very nature, irremediable. Apart from measures of eugenics—measures which will not be adopted in this generation and, when they are adopted, can but affect generations still unborn—nothing can root out an inherited tendency. Its opera-

---

<sup>5</sup> Chapter II, page 52.



TABLE XXII.—SUMMARY OF CONDITIONS

	DELINQUENT					NON-DELINQUENT		
	Boys		Girls		Average	Boys	Girls	Average
	Major Factor	Minor Factor	Major Factor	Minor Factor				
<i>I. Hereditary Conditions:</i>								
A. Physical . . . . .	2.4	48.9	4.2	51.5	53.1	30.5	33.2	31.8
B. Intellectual . . . . .	4.0	34.2	1.4	30.1	35.6	8.5	8.0	8.2
C. Temperamental (with pathological symptoms) . . . . .	11.3	26.1	15.0	35.4	42.2	24.0	15.5	19.7
D. Temperamental (with moral symptoms) . . . . .	8.8	117.1	12.4	168.0	145.9	32.5	41.5	37.0
Total . . . . .	26.5	226.3	33.0	285.0	276.8	95.5	98.2	96.7
<i>II. Environmental Conditions:</i>								
A. Within the Home.								
1. Poverty . . . . .	3.2	84.6	—	82.4	85.5	80.5	76.0	53.9 <sup>1</sup>
2. Defective family relationships . . . . .	5.7	111.4	12.3	143.5	131.3	38.0	32.5	35.2
3. Defective discipline . . . . .	8.9	82.9	8.2	51.7	79.5	12.0	11.0	11.5
4. Vicious home . . . . .	1.6	37.4	7.0	66.3	51.5	10.0	9.5	9.7
B. Outside the Home . . . . .	10.5	57.0	5.5	50.2	63.7	22.0	19.5	20.7
Total . . . . .	29.9	373.3	33.0	394.1	411.5	162.5	148.5	131.0

<sup>1</sup> See footnote 1 to Table IV.

tion, indeed, may be modified; its effects may be forestalled; its evil possibilities may be converted into good; and its deficiencies may be eked out or supplemented by positive training and teaching. But the inborn tendency itself, just because it is inborn, can never be uprooted. Influences, on the other hand, that reside in the environment, are in their essence not immutable: in theory, at any rate, they can be altered, if they cannot be removed. The distinction, therefore, should it be valid scientifically, is one of great practical moment.

It is proper, however, to realize that the antithesis is in some ways an abstraction. The alternatives implied are not wholly exclusive. Between what is instinctive and what is acquired, there is no sharp, clean-cut division. Even were the mind an

TABLE XXII.—SUMMARY OF CONDITIONS—*Continued*

	DELINQUENT					NON-DELINQUENT		
	Boys		Girls		Average	Boys	Girls	Average
	Major Factor	Minor Factor	Major Factor	Minor Factor				
III. <i>Physical Conditions</i>								
A. Developmental.	1.6	18.8	2.7	32.5	25.8	3.5	8.5	6.0
B. Pathological. . .	9.6	104.1	6.9	123.4	119.3	73.5	83.5	78.5
Total . . . . .	11.2	122.9	9.6	155.9	145.1	77.0	92.0	84.5
IV. <i>Psychological Conditions:</i>								
A. Intellectual. . . .	11.4	82.9	6.8	78.5	90.9	35.5	38.5	37.0
B. Emotional								
1. Inborn								
(a) Specific. . . . .	10.5	95.4	12.3	80.0	100.6	24.5	14.0	19.2
(b) General. . . . .	13.0	34.3	16.2	33.9	48.1	10.0	13.5	11.7
2. Acquired								
(a) Interests. . . . .	7.3	56.9	4.2	38.2	55.7	18.0	16.5	17.2
(b) Complexes. . . .	13.0	56.1	16.5	96.1	85.1	17.5	35.0	26.2
Total . . . . .	55.2	325.6	56.0	326.7	380.4	105.5	117.5	111.3
No major factor assignable . . . . .	3.7	—	1.4	—	—	—	—	—
Grand Total (II, III, and IV only <sup>2</sup> ) . . . .	100.0	821.8	100.0	876.7	937.0	345.0	358.0	326.8

<sup>2</sup> Hereditary conditions, enumerated under I as occurring in the family history, have not been included in the grand totals, since presumably they have already been reckoned, as occurring in the children themselves, in headings II, III, and IV.

edifice of two entirely separate stories—an innate foundation and a superstructure of learning piled up after birth, nevertheless, in actual fact, what we test and examine is not the architecture of the mind, but its processes; not detachable segments, but composite functions. No test measures pure native capacity, quite apart from all knowledge; no test measures in-born temperament, quite apart from developed habits and interests.

Let us, however, so far as our inexact methods will permit, endeavor to disengage the two and weigh the influence of all that is pre-natal against the influence of all that is post-natal.

To gain light upon this problem, I have tried to sort out every

case in which the factors, whether principal or accessory, were of a congenital type. Under this rubric I have included all such physical conditions as appeared to be directly inherited or at least constitutional, all intellectual conditions that are now generally assumed to be inborn (as mental deficiency and general dullness), all states of general emotionality not due to adolescence and all examples of a natural over-development of some primary instinctive disposition. Instances of mere educational disability, of repressed complexes and harmful habits, and of defective or undesirable interests, I have placed on the other side. We have thus a division of cases and causes into those predominantly congenital and those predominantly acquired.

Altogether, congenital factors, whether major or minor, are found some 249 times per cent among the delinquents, but only 72 times per cent among the non-delinquents. Non-congenital factors are entered 688 times per cent among the delinquents, and 254 times among the non-delinquents. Thus congenital factors have been recorded among delinquents rather more than three times as often as among non-delinquents, and non-congenital factors rather less than three times as often. If we consider in each case the major factor alone, we find it to belong to the congenital group among 36 per cent of the boys and among 41 per cent of the girls: so that, in well over one-third of all the cases, but in rather less than one-half, some deep constitutional failing proves the primary source of misconduct.

Hence, the share of innate conditions in the productions of juvenile delinquency is beyond doubt considerable. These, indeed, are the cases that are likely to prove the most obdurate and to stand mainly in need of palliative rather than punitive measures. But it would be a gross distortion—a mistake too commonly deduced from current fatalistic theories—to paint every criminal as the helpless victim of his inborn nature. At the same time, it will be perceived, there still remains a large balance of offenders—between 60 and 65 per cent of the total—whose lawless actions have been precipitated primarily by the difficulties of their environment or by the events of their own past life. Thus the part played by heredity or endowment

is in a majority of cases that of a minor or predisposing cause.<sup>6</sup>

The outcome of my whole analysis has been reduced to its simplest form in the last column of Table III.<sup>7</sup> The figures measure the degree of association between juvenile delinquency, on the one hand, and the various types of condition observed, on the other. With the loose data inevitable in sociological inquiries, statistical coefficients must not be too zealously pressed. Broadly speaking, however, the averages suggest the following deductions. All the conditions enumerated in the table—hereditary, environmental, physical, and psychological—are positively correlated with delinquency; but no one of them singly to a very high degree. To attribute crime in general either to a predominantly hereditary or to a predominantly environmental origin appears accordingly impossible; in one individual the one type of factor may be preëminent; in another, the second; while, with a large assortment of cases, both seem, on an average and in the long run, to be of almost equal weight.

Judged by the coefficients, the following proves to be the order of importance of the various conditions we have reviewed: (1) defective discipline; (2) specific instincts; (3) general emotional instability; (4) morbid emotional conditions, mild rather than grave, generating or generated by so-called complexes; (5) a family history of vice or crime; (6) intellectual disabilities,

---

<sup>6</sup> The distribution of principal causes into congenital and non-congenital reveals a proportion at first sight decidedly dissimilar in my own cases to that announced by previous investigators. The disagreement, however, is not beyond all hope of reconciliation. Differences in material and differences of classification often seem capable of explaining it away. Healy, for example, whose thorough case studies are often cited by hereditarians, finds environmental influences playing the decisive part in only 25 per cent of his examinees. He, however, has dealt with recidivists alone—with older, more hardened, and more frequently offending types; many of them, too, having been picked out by the court as in special need of examination at a psychopathic institute, comprised a number disproportionately large of gross aberrations of a constitutional kind. My own cases, on the other hand, have been selected, so far as possible, to form a fair representative sample of the ordinary city delinquent, and therefore reveal external influences more clearly (see *Brit. Journ. Med. Psych.*, 1923, III, i, pp. 1-2; and, for a further discussion of other findings on this problem, *ibid.*, pp. 17-18).

<sup>7</sup> See again page 51.

such as backwardness or dullness; (7) detrimental interests, such as a passion for adventure, for the cinema, or for some particular person, together with a lack of any uplifting pursuits; (8) developmental conditions, such as adolescence or precocity in growth; (9) a family history of intellectual weakness; (10) defective family relationships—the absence of a father, the presence of a stepmother; (11) influences operating outside the home—as bad street companions and lack or excess of facilities for amusement; (12) a family history of temperamental disorder—of insanity or the like; (13) a family history of physical weakness; (14) poverty and its concomitants; and, last of all, (15) physical infirmity or weakness in the child himself.

Heredity appears to operate, not directly through the transmission of a criminal disposition as such, but rather indirectly, through such constitutional conditions as a dull or defective intelligence, an excitable and unbalanced temperament, or an over-development of some single primitive instinct. Of environmental conditions, those obtaining outside the home are far less important than those obtaining within it; and within it, material conditions, such as poverty, are far less important than moral conditions, such as ill discipline, vice, and, most of all, the child's relations with his parents. Physical defects have barely half the weight of psychological and environmental. Psychological factors, whether due to heredity or to environment, are supreme both in number and strength over all the rest. Intellectual conditions are more serious than bodily, and emotional than intellectual; while psycho-analytic complexes everywhere provide a ready mechanism for the direction of overpowering instincts and of compressed emotional energy into open acts of crime.

If we consider major causes only, the inferences are much the same. Among personal conditions, the most significant are, first, the mental dullness which is not severe enough to be called deficiency, and, secondly, the temperamental instability which is not abnormal enough to be considered pathological. Among social conditions by far the most potent is the family life, and next to it, the friendships formed outside the home. These four conditions are paramount. Between them, as main determining factors, they account for more than 50 per cent of juvenile



delinquencies and crimes. Every cause and every influence, however, no matter what its special form may be, is found to operate, and can only operate, through its inner psychological effects. Conduct and misconduct are always, in the last analysis, the outcome of mental life.

### Efficacy of Treatment

Of the cases here examined, nearly all have been under supervision for at least three years, many for nearly nine or ten. It is possible, therefore, to glean some preliminary notion of the efficacy of the measures advised.

Let me select those cases with which, directly or indirectly, I have been able to keep in touch over a period of twelve months or more. They may be divided into two groups: first, those in which the essential recommendations were duly carried out; secondly, those in which it was not found practicable to apply or to maintain the treatment recommended. In number the two groups are almost equal. Among the former, I find that in 62 per cent an apparent cure resulted—that is, no delinquency has been notified for at least one year and no fresh delinquency seems likely to ensue. In 38 per cent progress has been, on the whole, satisfactory, though incomplete—that is, either the delinquencies more recently reported have diminished in number and gravity, or else, though no delinquencies have been reported, there still remains a suspicion that they have been or may be repeated. In only 2 per cent have the reports proved wholly disappointing. Within the second group, those where the treatment advised was not adopted, 12 per cent appear to have undergone a cure, spontaneous and complete, 23 per cent appear to be making moderate progress, the large, unsatisfactory remainder consist for the most part either of cases of some deep congenital disorder or of cases where some hopeless home condition from which the child cannot be permanently freed is lurking in the background.<sup>8</sup>

---

<sup>8</sup> The children thus followed up constitute no more than a handful—but 137 in all. A more detailed survey I propose to publish later on, when it has been possible to follow up a larger number of cases for a longer period of time. The percentages given in the summary above, therefore, are to be viewed as but rough and preliminary figures.

It is a familiar saying that knowledge of a subject has never reached a truly scientific stage until it can be made a basis for reasonable prediction. Astronomy is a science, and we deduce the hour of an eclipse from our knowledge of the heavenly bodies. Physics is a science, and we deduce the volume of a gas from our knowledge of the effects of temperature. Has criminal psychology attained or approached, in any measure, to this deductive plane?

The groups just studied have been small, the methods of inquiry have been empirical, and the duration of the whole research has covered scarcely ten short years. The results put forward, therefore, can claim to be no more than first approximations. Any conclusions must be tentative, and any hypothesis provisional. Nevertheless, the figures quoted seem to show beyond demur that, for many cases and within a wide margin, a forecast is permissible. After an intensive study of the child and his conditions, after a reasoned assignment of his causal category, the outlook achieved over his whole situation will generally afford some warrantable guide for discreet prognostication. We can say of one that, were his home circumstances improved and a proper occupation provided, his high intelligence would be certainly sufficient to induce a reform; of another that, after the crisis of adolescence is over, he will probably settle down to honest work; of a third that the one hope of a recovery lies in a swift removal from the old home and the old associations; and of a fourth that his mind is so deeply and incurably defective that there is no other safeguard but to seclude him in an institution for the remainder of his life.

Nor are our conclusions limited to individuals alone. We may extend them to the treatment of the whole problem of juvenile delinquency. We may, having learnt a little of human nature in the young, attempt to lay down certain broad and general principles for the prevention of crime in general, as well as for the reclamation of the particular case. These practical deductions, the upshot of the whole inquiry, may be summarized to the following effect.

1. All young persons who show delinquent tendencies should be dealt with at the earliest possible stage. Parents

should be taught that the pre-school period is a period vitally decisive: it is then that the foundations both of moral character and of temperamental eccentricity are first laid down. Teachers should be urged to watch, and when necessary to notify, all who show antisocial inclinations; the reports should be made in the infants' department or at the latest soon after the child's promotion to the senior school. In the school itself, the training of character as well as the instruction of the intellect should form an integral part of education. When at last the school period is over, after-care workers should be persuaded to extend their supervision to the social conduct, as well as the industrial efficiency, of children who have just left; and, above all, special efforts should be made to meet the transitional phase of adolescence.

2. The problem of delinquency in the young must be envisaged as but one inseparable portion of the larger enterprise for child welfare. Crime in children is not a unique, well-marked, or self-contained phenomenon, to be handled solely by the policeman and the children's court. It touches every side of social work. The teacher, the care committee worker, the magistrate, the probation officer, all who come into official contact with the child, should be working hand in hand not only with each other, but with all the clubs, societies, and agencies, voluntary as well as public, that seek to better the day-to-day life of the child.

3. The delinquent himself must be approached individually as a unique human being, with a peculiar constitution, peculiar difficulties, and peculiar problems of his own. The keynote of modern educational thought is individuality—self-realization, to be sought and attained, not by collective instruction nor by imposed uniformity and repression, but by separate adjustments and readjustments for each particular child. If this is needed for the normal, how much greater must be the need among the abnormal, the neglected, the delinquent! The court, therefore, and whatever authority has to grapple with such cases must at all times regard not the offense, but the offender. The aim must be not punishment, but treatment; and the target not isolated actions, but their causes. Since these causes seldom float con-

spicuously upon the surface, such authorities must have access to all available information and possess means to make for every case intensive investigations of their own. On each main aspect, they must have expert help. A social investigator must report upon home circumstances; a medical officer must inspect the child for physical defects; a psychologist must be at hand to apply mental tests, to assess temperamental qualities, and to analyze unconscious motives. A psychological clinic embodying all these different workers studying the same cases scientifically, side by side, is the most pressing need of all.

4. The remedies, in the same way, will be adapted, not to the nature of the offense, but to the nature of the factors provoking it. Already, the outworn maxim of traditional justice that the punishment should fit the crime, though set to memorable music in an optimistic key, is now giving place to the sounder principle that the treatment must fit the delinquent. Full advantage is to be taken of the various methods of disposal sanctioned by the newer statutes. Probation should be employed with a larger freedom, and at the same time with finer discrimination; it should include, for each separate case, not merely passive surveillance, but active and constructive efforts. Institutions for the delinquent should continue their laudable development towards a less uniform organization and a less repressive code. Special establishments, more particularly, are wanted not only for the defective and for the supernormal, but also for the dull who cannot be certified as defective and for the unstable and neurotic who cannot be treated as insane. And, with a minuter classification both of cases on the one hand and of voluntary homes and residential schools on the other, efforts should be made to assign each ill-adjusted child to the place most suited to his special needs. After-care, in particular, calls for further extension: to lavish a hundred pounds upon the intensive training of a youth in an institution and then suddenly to fling him loose into the old environment, sparing neither time nor trouble for further aid and following-up, is not economy but waste.

5. Fuller knowledge is urgently wanted: it is wanted both in regard to the causation of crime and in respect of the relative

efficacy of different remedial measures. Only from the organization of research can this fuller knowledge come, and organized research means an established criminological department. The fruits of such research should be made immediately accessible to the practical officer, and courses of instruction should be arranged where all who have to deal with the young offender may learn the latest and best accredited results of modern criminal psychology.

6. Finally, society must aim at prevention as well as at cure. Housing, medical treatment, continued education, the psychological study of children in the schools, improved industrial conditions, increased facilities for recreation, the cautious adoption of practicable eugenic measures, and, above all, sustained investigation into all the problems of childhood—these are but a few of the countless needs to be supplied, if delinquency in the young is to be not merely cured as it arises, but diverted, forestalled, and so far as possible wiped out.

Poets have extolled the innocence of infancy, the birthright of each growing boy before the shades of the prison house close over him. The psychologist, the teacher, the harassed parent, know too well that moral perfection is no innate gift, but a hard and difficult acquirement. The perfect child has still to be born and bred. And the practical man can but echo the aspiration of Anatole France: "*Espérons dans ces êtres inconcevables qui sortiront un jour de l'homme, comme l'homme est sorti de la brute. Saluons ces génies futurs!*"<sup>9</sup>

---

<sup>9</sup> *Le Jardin d'Épicure*, pp. 115-16. "Let us hope for these inconceivable beings who shall one day develop out of man, as man has evolved from the brute. Let us salute these future prodigies!"





## APPENDIX I

### SAMPLES OF HANDWRITING, COMPOSITION, AND PHYSIOGNOMY

IN Figures 21-24 I have reproduced specimens of the handwriting and composition of four typical delinquents, two boys and two girls. The portraits of the two girls are shown in Figure 20; those of the two boys in the frontispiece and in Figure 19. From the specimens of correspondence subjoined some notion may be gleaned, clearer and more concrete than a whole chapter of verbal descriptions, of the mentality possessed by young people of this class. The reader will find it an easy and instructive exercise to determine for himself before he reads further which of the four individuals photographed wrote each of the four letters reproduced, and then, having allotted each note to its proper author, he may deduce, both from the physiognomy and from the style of writing, spelling, and expression, what were the intelligence, the temperament, and the educational attainments of the several children.

The two boys represent a contrast in intelligence; the two girls, a contrast in temperament. Of the boys, the first (B.I, Figures 1 and 22) was exceedingly dull and backward (mental ratio, 74); he had committed a series of petty thefts and one or two senseless sex offenses. The second (B.II, Figures 19 and 21) was of a superior intelligence (mental ratio, 114), and though coming from a rough quarter, had been educated at a central school. He was arrested for absconding to Brighton with a sum of several pounds stolen from his employer. Of the girls, the first (G.I, Figure 20, portrait on reader's left, and Figure 23) was of a highly emotional and unstable temperament, unrepressed, and over-sexed. She had committed several thefts, chiefly in coöperation with two elder girls who had eluded arrest and was drifting into a life of prostitution. The second (G.II, Figure 20, portrait on reader's right, and Figure 24), though not outwardly emotional or obviously unstable, was of a repressed, reserved, and almost surly type. She appeared to have inherited a strong instinct of pugnacity; and though ordinarily restrained and well-behaved, was liable to outbursts of violent temper and had committed several grave assaults. The intelligence of the two girls was nearly average (mental ratio, 94 and 96 respectively).

All their notes were written from the same place at about the same date, and refer (or might have referred, had the writers thought fit) to much the same circumstances. The girls, it will be

seen, discuss a recent outbreak of rowdiness among the boys; the boys make no reference to their own behavior and are content simply to ask for promised photographs. But the writing, phrasing, and general arrangement of the letters are even more diagnostic than the topics or the tone.

SYSONBY HOUSE,  
RIVERSIDE VILLAGE,  
MELTON MOWBRAY.

Dear Mr. Burt

I now take the pleasure in writing these few lines trusting it will find you in the pink of condition as we are all about the same at the present time. I am sorry to say that the boys have been behaving most disgracefully what with smashing doors, windows, crockery etc. we dont know what to do about it there isnt a sound window in the house and they dont seem to realize what they are doing. It seems to me that if there was someone more stricter down here they would not go on like they do. they have every pleasure they want & could wish for nothing better they seem to take advantage because people are easy with & I must say they are too easy with us altogether. We would give anything for them to settle down and make this place there future home and I am sure you would do the same. I am sure it is making poor Mr. A—— downright ill and dont seem as this sort of thing can go on much longer as there is no comfort whatever here where these boys are at times. but I must say they have got a little better this last week or so. Dear Mr. Burt I should very much like a few photos of myself as I have seen Emmas & they look grand. but please if you cannot spare them dont send them and I will make do without them. Dear Mr. Burt I must now close my letter trusting to see you or hear from you soon I close with best love to you

Excuse writing

I remain

Yours Truly

L——

E—— W——

SYSONBY HOUSE,  
RIVERSIDE VILLAGE,  
MELTON MOWBRAY.

Dear Mr. Burt

I am so sorry being so late with an answer. I hope you are quite well Mr. A—— has not been very well. I was so pleased with the photos you sent and the nice letter Liz and I are going to Mr Thurmans to tea. I had a happy birthday I had a lot of



FIG. 19. "B. II," AGED 14 $\frac{3}{4}$



FIG. 20. "G. I" (LEFT), AGED  $16\frac{2}{12}$ , AND "G. II" (RIGHT),  
AGED  $15\frac{7}{12}$



*presents and a strawberry tea and lovely cakes. Mr Davies gave me a present when I only knew him too days. I was surprised to have a letter from you. The boys have done a lot of damage they think we admire it but we dont so we dont take any notice. Girls have a lot of influence over boys though they are stronger than us. I must now close with [best] <sup>1</sup> love*

*From E—*

*P.S. This is my very best writing*

---

<sup>1</sup> Deleted.

## APPENDIX II

### THE PSYCHOLOGICAL CLINIC FOR JUVENILE DELINQUENTS

FOR the successful treatment and prevention of juvenile delinquency, there is one measure which seems as essential as it is definite and which has frequently been referred to in the text—the establishment of psychological clinics. Most of the other measures advocated are familiar in this country. The psychological clinic is new. Hence, some account is needed of its history, aim, organization, and possible methods.

#### History

In the United States many institutions of this kind have now been established. For long, American state prisons and reformatories had already enjoyed the services of a psychologist or psychiatrist as a permanent member of the staff, but it was not until 1909 that the scientific study of young delinquents along medico-psychological lines was undertaken as a regular service for the municipal court. The first psychiatrist to be attached to a juvenile court was Dr. William Healy: at the psychopathic institute at Chicago and afterwards at the Judge Baker Foundation, Boston, Dr. Healy's work has been, and still remains, a model for all such enterprises. Throughout the United States the movement has rapidly spread. During recent years, in connection with the city courts, psychiatric clinics have been set up at New York, Philadelphia, Cincinnati, Columbus, St. Louis, and elsewhere. Two traveling clinics have been provided by the National Committee for Mental Hygiene; they move from town to town, give free demonstrations, and are available in any part of the United States. Last of all, along these and cognate lines, the American Commonwealth Fund has now undertaken a five-year program for the prevention of delinquency.<sup>1</sup>

---

<sup>1</sup> See *The Commonwealth Fund Program* (reprinted from 4th Annual Report, and published by Joint Committee on Methods of Preventing Delinquency, 50 East 42nd Street, New York City, 1923) and V. V. Anderson, *The Psychiatric Clinic in the Treatment of Conduct Disorders of Children and the Prevention of Juvenile Delinquency* (National Committee for Mental Hygiene, 370 Seventh Avenue, New York City, 1923). Reference may also be made to the relevant publications issued by the Children's Bureau of the U.S. Department of Labor, Washington, more particularly those on *The Practical Value of the Scientific Study of Delinquents* (1922) and *Juvenile Court Standards* (1923).

18/7/16  
F. R. HOARE,  
WARDEN.  
~~RIVERSIDE VILLAGE~~  
FOR BOYS AND GIRLS.  
A.W.....  
Sycamore House  
Riverside Village  
MELTON-MOWBRAY.  
ASFORDBY ROAD  
MELTON-MOWBRAY

Dear Mr Bert.

Just a line asking you  
if you will be so kind as to let me  
have some of the photo's you took of  
me. Kindly oblige yours truly  
A.W.....

FIG. 21. SPECIMEN OF HANDWRITING OF "B. II"

Mr  
Bert

will you send me my  
photots what you took  
of me

FIG. 22. SPECIMEN OF HANDWRITING OF "B. I"

Mr Bart I must now close my letter  
trusting to see you or hear from you  
soon I close with best love to you  
I. Remain  
Yours truly  
L.....

FIG. 23. SPECIMEN OF HANDWRITING OF "G. I"

notice. Girls have a  
lot<sup>of</sup> influence over boys  
though they are stronger  
than us.

I must now close with  
~~best~~ love  
From E.....

P.S. This is my very best  
writing

FIG. 24. SPECIMEN OF HANDWRITING OF "G. II"

The primary purpose of such clinics is to make a scientific study of difficult or delinquent children referred from the schools or the juvenile court and to carry out or recommend sound methods of treatment. As a rule, they are financed either wholly or in part by private individuals or private corporations. One or two, however, starting as voluntary enterprises, have since been taken over by the municipal or educational authorities. It is urgently to be hoped that similar institutions will be organized in this country. Small beginnings have already been made in this direction at London, Birmingham, Glasgow, Stoke-on-Trent, and elsewhere.<sup>2</sup>

---

In addition to psychological clinics established specifically for this work, facilities for the medical and mental examination of delinquent children exist, it is stated, in about three-quarters of the juvenile courts in America with a population above 100,000 (see the reports of the Children's Bureau just cited). In many instances, the facilities used are connected with state institutions for the feeble-minded or insane (used by about 50 courts); often they are attached to the universities (used by about 20 courts); sometimes they form part of the public school system (used by about 16 courts); almost as frequently they form part of the court organization itself (this is so in 15 courts); more rarely they are arranged and maintained by the City or County authorities (and are so used by about 4 courts). Frequently, however, such mental examinations as may seem required are carried out by a medical officer or a general practitioner, and there is no evidence that these examiners possess any special knowledge of the methods of mental diagnosis.

As I have already noted in the text, at Detroit, Chicago, San Francisco and elsewhere, there are elaborately organized places of detention, and psychological investigations are made there while the child is on remand (see pp. 102-5).

<sup>2</sup> Special reference should be made to the Birmingham scheme for the examination of offenders who are mentally inefficient. The scheme has been defined as "one by which the Justices endeavor to ascertain whether a person, not amenable to the Mental Deficiency Act, has committed his offense under the influence of some mental disturbance or physical disability." (For fuller details see the *Annual Reports of the General Purposes Committee*, Victoria Courts, Birmingham, from which this definition is taken.) Two psychological experts have been appointed by the Birmingham Justices—Dr. Hamblin Smith to examine adult offenders at the Prison and Dr. W. A. Potts to examine children. Owing to unforeseen difficulties, the children referred for examination are but few, sometimes no more than one in the course of twelve months. On the other hand, as many as two hundred adults and juvenile adults have been remanded in the course of a year for special examination and report, and the whole of these cases are undertaken by Dr. Hamblin Smith unaided (see his reports appended to the *Annual Reports of the Commissioners of Prisons*, especially those for 1922, p. 39, and 1923, pp. 50-52).

With the limited use made in English cities of a single part time



## Organization

The minimum needs of such a clinic are a staff, an office, and a limited amount of laboratory equipment.

1. The *staff* should include (a) a *senior psychologist*, specially experienced in the sympathetic handling of young children, and an expert in what may be called analytical methods;<sup>3</sup> (b) a *junior psychologist*, trained more particularly in the methods of routine testing. That two psychologists at least should have the handling of each child is an arrangement that is highly advantageous: the same child responds differently to different personalities; and the discussion of his problem from more than one point of view is always fruitful. Of the two psychologists one should be a man and the other a woman. If no physician is on the staff, one of them should possess medical and psychiatric experience. (c) In addition, there should be one or more *social workers* trained in the analysis of social problems, capable of making systematic case reports, familiar with the industrial life of the district and with the problems of the working classes, and in touch with the various agencies for charity and relief. (d) Owing to the great importance of full and accurate records, a *shorthand typist* is almost indispensable; if the work is small, the typist may also act as a filing clerk.

2. Privacy is vital. Hence, the *office* should comprise a suite of at least five rooms. There should be (a) a well-ventilated waiting room; (b) a consulting room where the parent can be interviewed by one investigator while (c) in a second consulting room the child himself is being examined by another. One of the two consulting rooms should be large, and available for conferences in which the

---

officer to cope with the innumerable cases that call for expert examination, the extensive staff employed in many American cities may well be contrasted. Philadelphia (to cite but one example), a city with a population similar in magnitude to that served by the Birmingham Prison, employs in its municipal court a medical director, two psychologists, two surgical specialists, four psychiatrists, and six women physicians. In London, indeed, the psychologist now has the advantage of systematic reports from organizers of children's care, of voluntary assistance from post-graduate research students, and often (for many older cases requiring vocational guidance) of the investigators of the National Institute of Industrial Psychology: special medical examinations are carried out at the Public Health Department by the school medical officer, or are arranged at suitable hospitals through the Branch for Children's Care. In most other towns in Great Britain, though medical assistance is usually available, expert psychological advice hardly ever is.

<sup>3</sup> By analytical methods I mean not merely the special technique of psycho-analysis, but the more general power to win confidence, extract the child's own story, and penetrate and unravel the motives of the abnormal mind.

whole staff and outside visitors may join: this room should have two entrances, so that the parent may be called in from one room while the child is withdrawn into another, without meeting. (d) For files and for typewriting, another small room will be needed. (e) In addition, there should be a small laboratory for special psychological tests; it should be remote from the noise of the typing and of the waiting room, and admit of being darkened at will.<sup>4</sup>

3. The *laboratory equipment* need be neither elaborate nor expensive. Reaction-time apparatus and galvanometers will hardly be required; tests involving such instruments as these can best be carried out at the psychological department of the university. To begin with, little more will be wanted beyond simple apparatus for the examination of the senses, materials for tests of a performance type, and a large supply of printed test sheets.<sup>5</sup>

Such a clinic might be established either as a private institution, or else as an adjunct to the juvenile court, the local education department, or the university.

On the whole, it would seem, the course least desirable is to house the psychologist in the same building as the juvenile court or in or near the prison or remand home. Parents should be encouraged to come to the clinic in the same spirit as they would approach a private or family physician, and the child himself should be protected from any sense of disgrace and from undesirable contact with older delinquents. Special arrangements to prevent absconding from the clinic are unnecessary and inimical to the work itself.

That the psychologist and his clinic should be limited solely to the study of delinquency is not essential. In smaller cities, they may form part of a wider institution dealing with mental deficiency, educational backwardness, choice of employment, and other problems demanding psychological methods of inquiry. In such a case, the clinic might be attached to the education department, or even to some medical institution, or institute for vocational guidance.

But the clinic, like the hospital, though primarily existing to give advice in individual cases, should also take upon itself the duties of teaching and training. It will act as a demonstration school where teachers, medical officers, social workers and probation officers may gain practical experience and a knowledge of the different cases they are likely to meet. In addition, at any rate during the early stages, one of its most urgent functions must be research. On these grounds, therefore, probably the best plan for the immediate present

---

<sup>4</sup> These suggestions are based on the arrangements obtaining in the psychological laboratory of the National Institute of Industrial Psychology.

<sup>5</sup> See note on tests below.

would be the foundation of a criminological department at a university, of which the clinic would form an integral part.

Wherever it be fixed, it can never work in isolation. Alone and of itself, the clinic can do little by way of treatment and will be gravely handicapped in gathering information. Here lies the supreme value of having at its back the medical and educational departments of the county or borough. In addition, it should be in close communication with the hospitals, the schools, and the social agencies of the district. In most cases, the special medical and the neurological examinations will best be carried out at the hospital. There should always, however, be some one on the staff competent to conduct a routine physical inspection, and able to detect the commoner children's ailments and symptoms and the need for a more thorough examination by a specialist. In the near future, with the introduction of psychology into the several training courses, it may be expected that teachers themselves will be able to test fully the child's educational equipment and send in trustworthy reports; and that social workers with psychological knowledge will be able to report on home conditions from a psychological as well as an economic standpoint.

### Aims

The chief work, therefore, of the clinic itself will be special examinations by the technical methods of psychology. Nearly always in the past the psychiatric study of delinquents has been concentrated on the diagnosis of mental deficiency and psychosis. The results have been to limit the work of such institutions mainly to the detection of mental diseases popularly regarded as incurable, to exaggerate the proportionate incidence of such diseases, and to assimilate minor forms of abnormality to these outstanding types by the use of such vague terms as "morally defective," "psychopathic," "degenerate," or "borderline deficiency." That most delinquents are from a medical standpoint normal rather than diseased has never been sufficiently recognized: it is the abnormal that are commonly picked for special investigation; but it is the normal, or those who are nearly so, that best repay scientific study and treatment.

But the clinic will not be content with mere diagnosis. It will also undertake or supervise the work of treatment and of following up. It cannot be too strongly emphasized that merely to apply a few tests of intelligence and to tag the child with some learned label is inadequate. A one-man study, with a hurried report after a one-hour interview, can be of little value. To deal with the child from a single aspect alone may be quite as fruitless as to leave him to the shrewd guesses of the magistrate who has seen him for ten minutes in the courtroom. After each case has been examined, a round-table

conference should be held, in which all the various experts concerned—medical, legal, psychological, educational, and social—will take their share and offer their advice, and it will be from these joint discussions that the most profitable results will arise. From time to time there must be reexaminations, constant visits to the home, and repeated consultations with parents, teachers, guardians, and the various social agencies that may undertake the detailed treatment of the child.

### Residential Centers

An ideal institution should include not merely a day clinic, but also a residential observation center. The two should bear much the same relation to each other as the out-patients' and in-patients' departments of the ordinary hospital, but need not necessarily be lodged in the same building. With many borderline cases of mental and temperamental deficiency it is impossible to arrive at a correct diagnosis, or to discover the mental mechanisms at work, without a prolonged expert observation of the child under standardized conditions. The child must be placed in surroundings where the shortcomings of the ordinary home are ruled out, and where at the same time he may be allowed a full opportunity to manifest his natural tendencies among a group of his own fellows.<sup>6</sup>

### Methods

Two problems are bound to confront the workers in such clinics as I have described: two questions are put to me again and again by those who carry out individual examinations of delinquents and

---

<sup>6</sup> Of the few attempts made to establish such observation centers, the institute near Namur, in Belgium, known as L'Établissement Central d'Observation à Moll-Huttes, is perhaps the most original. It forms a kind of idealized remand home. Here "children of justice" between seven and twenty-one years of age are sent for special study and classification. The principle of selection is briefly that "*l'observation prolongée est nécessaire pour les cas mentaux non évidents et pour tous les cas affectifs.*" The conditions are as free and as natural as possible. The child is stimulated to reveal himself "*tel qu'il est, non tel qu'on le voudrait.*" He remains for two to four months. Reports are drawn up and revised according to a systematic scheme; a final bulletin is then sent with the child to the magistrate, advising whether he should be returned to his own home, transferred to a foster home, kept in "semi-liberty," or sent to some institution of a reformatory, vocational educational, or other type. (I am indebted to the superintendent, M. Rouvier, for a detailed account of the aims and methods of his unique institution. See also Miss Margery Fry, "A Belgian Psychological Laboratory," *Howard Journal*, 1924, I, iii, pp. 121-9.)

others: first, what tests are we to use? secondly, in what units are we to record our measurements? If data obtained in different parts of the country are to be truly comparable, it seems plain that both the tests and the units employed should be the same in all inquiries. A few brief remarks on both may accordingly be helpful here, and will serve to explain in greater detail the methods I have used and have referred to in the text.

### 1. Tests

The following may be suggested as a minimum list of tests and test material that may from time to time be needed at the clinic:

(a) *Physical Measurements*.—(1) Stadiometer for measuring height. (2) Weighing machine. (3) Centimeter tape for head and chest measurements. (4) Two stop watches.

(b) *Intelligence Tests (Verbal Type)*.—(1) Apparatus and record-forms for the *Binet-Simon Tests*, both in their original form and in the *Stanford Revision and Extension*. (It is essential that in determining mental ages by these tests, the age assignments used should be those obtained by standardization upon English children—preferably from the locality in which the tests are to be used.) (2) Printed blanks for *group tests* of intelligence. (For children of school age I am disposed to recommend the *Northumberland Standardized Tests of Intelligence, 1925 Series*, published by the University of London Press, and, for older and brighter persons, the *National Institute Group Tests, Series 33*, to be obtained from the Secretary of the Institute, 329, High Holborn, W.C.1.) (3) Printed cards for *Reasoning Tests* and other supplementary tests of a similar nature.

(c) *Intelligence Tests (Performance Type)*.—A large variety of these will be necessary: *e.g.* (1) the *Séguin Form-Board*. (2) *Godard's Adaptation Board*. (3) *Geometrical form-boards* of various degrees of difficulty (2-figure form-board, 5-figure form-board, *Casnist form-board*, *Gwyn's Triangle*, *Kemp's Diagonal*, *Healy's Construction Puzzle A*). (4) *The Knox Cube Imitation Test*. (5) *Healy's two Pictorial Completion Tests*. (6) *Healy's Puzzle Box*. Blanks for the *Porteus Maze Tests*, the *Wells and Woodworth Substitution Tests*, and other non-verbal tests of a paper type will frequently be required. (A description of these tests, with standardized results obtained from London school children, will be found in *Miss F. Gaw's report on Performance Tests of Intelligence*, Medical Research Council, 1925.)

(d) *Scholastic Tests*.—Test sheets and printed cards for testing the various subjects of the elementary and secondary school curriculum. For individual testing, probably the most completely standardized are those in the *Handbook of Tests for Use in Schools* (P.



S. King & Son); for group testing the Northumberland Standardized Tests of English and Arithmetic (University of London Press) may be conveniently used with the Intelligence Tests in the same series.

On the testing both of intelligence and of school attainments, the reader may usefully refer to Dr. Ballard's books—*Mental Tests*, *Group Tests*, and *The New Examiner*—which contain not only a sound and simple introduction to these newer methods, but also much fresh and ingenious test material.

(e) *Tests for Special Abilities*.—Those of Whipple are the best standardized; see his *Manual of Mental and Physical Tests*, to which the test numbers in brackets refer. The following are the most frequently required: (1) Snellen's test types (E pattern); with other test types, frames, and lenses for visual acuity (test 14A and B). (2) Dynamometer (test 6). (3) Pressure-pain balance (test 22). (4) Steadiness of motor control (test 13). (5) Memory tests (tests 38 and 39). (6) Tests of general knowledge, range of information, size of vocabulary, imagination (tests 45, 46, 50, 51). To these may be added (7) the Whipple-Healy tapping test; (8) Healy-Bronner learning tests; (9) Kraepelin adding test (for fatiguability); (10) Kohs' block-design tests; (11) Kelley's test of constructive ability; (12) tests for visual and auditory imagination; (13) tests of æsthetic appreciation; (14) tests of testimony and report.

Most of the apparatus for these and for the performance tests can be obtained from the C. H. Stoelting Co., Chicago.

(f) *Temperamental Tests*.—(1) Test material for association tests (Jung: Kent-Rosanoff, with standardization of replies). (2) June-Downey will-temperament tests. (3) Pressey X-O tests of emotionality. (4) Raubenheimer's tests of character. (The majority of these need considerable adaptation before they can be usefully applied to English children. For references and further suggestions see above, Chapter IX.)

(g) *Vocational Tests*.—Among the more useful are (1) Stenquist's tests of mechanical ability; (2) the American Army trade tests; and (3) such tests for special occupations as the dressmaking, clerical, and engineering tests worked out by the National Institute of Industrial Psychology.

(h) *Miscellaneous*.—Toys, models, picture books, appealing to a variety of childish tastes. Test blanks, specially printed as occasion requires. Printed record forms: (separate schedules will be advisable for (1) medical examiner, (2) social investigator, (3) teacher's report, (4) report on tests, (5) synoptic summary, (6) card index. See sample schedule and record card printed above, pages 22-5).

## 2. *The Standardization of Measurements of Development*

Of the routine work in any psychological clinic a large part must inevitably consist in the taking of mental measurements by means of tests like those just described, and in the comparison of such measurements both with normal standards and with physical measurements of the same individual. In order that the estimates for different qualities can be compared with one another and the work of various clinics proceed on a similar basis, the same unit of measurement, so far as possible, should everywhere be used.

At present, the method that is at once the commonest and the simplest is to measure mental capacity in terms of age. This device has been relied upon throughout the present volume, and has been extended even to physical measurements. To measure physical and mental growth in terms of an equivalent developmental age is a method at once intelligible to the plain man. It will always have its uses. Nevertheless, for exact purposes, it is, I am convinced, unsatisfactory, and in many cases it is impracticable. The proper unit, the only unit which can be universally applied, must be, as I have insisted in earlier papers and reports, a unit based on the degree of variability at each age. This may be either the standard deviation or the percentile.<sup>7</sup>

Every psychological clinic and every psychologist whose office it is to measure aberrant individuals, should begin by collecting standardized measurements from the normal population of his district. Too often the examining officer sees none but the abnormal. By using group methods such preliminary standards should not be difficult to procure.<sup>8</sup>

In the assessment of physical development the requirements are much the same as in assessing psychological, and the same units should be used. With all the innumerable measurements of children's height and weight taken annually during the school medical inspections in this country, it is as strange as it is unfortunate that practically no data have been published showing the frequency of different degrees of deviation. Reports are content to give averages

---

<sup>7</sup> See *Distribution of Educational Abilities*, pp. 47 *et seq.* The reader will have noted that my definitions of mental and temperamental deficiency and my grading of qualitative characteristics like emotional tendencies are based upon the method of percentiles.

<sup>8</sup> For the group tests mentioned in the foregoing section norms are given in the manual that accompanies them. For the ordinary Binet tests revised age-assignments will be found in my *Handbook of Tests* and percentiles and standard deviations in *Mental and Scholastic Tests* (pp. 145 and 151). For the Stanford version norms from London children exist in roneo'd copies; and are shortly to be published.

for the various ages and nothing more: measures of variability or tables of distribution are hardly ever attached.<sup>9</sup>

As regards puberty, suitable figures for comparative judgments are in this country almost entirely lacking. Data for trustworthy standards, showing the normal age of pubescence and the frequency of deviations above and below, are urgently needed both for boys and for girls.<sup>10</sup>

I suggest, then, that one of the first tasks of the practical psychologist should be to collect frequency tables for each of these developmental traits, physical, physiological, and mental. From such tables standard deviations and percentiles may be calculated. For rapid use simple charts may be compiled, enabling the investigator to read off at a glance what percentile and what multiple of the standard deviation correspond to any individual measurement. The measurements should be expressed as plus or minus so many times as the standard deviation, and averages should be based on these figures. The percentiles will be used mainly for interpreting in a concrete way the significance of these more technical expressions.

To standardize assessments of temperament and character will be

---

<sup>9</sup> In an appendix to my report on *The Distribution of Educational Abilities* (Table XXX, p. 88) will be found measures of variability for the height and weight of London school children; the standards there given have been my guide in the present inquiry. Percentiles for American children have been published by F. Smedley, "Report of Department of Child Study," No. 3, *Report of Board of Education, Chicago* (1900-1); and his percentile charts for height are reprinted in Whipple's *Manual of Mental and Physical Tests* (2nd ed., 1914), pp. 68-9.

<sup>10</sup> The rough standards referred to in Chapter V were based on a small special inquiry upon a random sample of non-delinquents. This inquiry gave, for the threshold of pubescence, an average of 14.8 years among boys and 14.2 years among girls—brunette girls (except those of Jewish or Mediterranean stocks) being somewhat later than blonde. The standard deviation for the girls was 1.9 years; for the boys 1.1 years.

The small size of the group (300 for either sex) and the difficulties of the examination in the case of the boys, render the figures for variability, particularly for male variability, of little worth. For a practical method of gauging the stage of pubescence reached by a growing boy see W. C. Crampton, "Statistical Methods," *Am. Physical Educ. Rev.*, XIII (1908), pp. 20-31, and "Physiological Age," *ibid.*, pp. 141-54, 214-27, 268-83, 345-58. Cf. also Bird T. Baldwin, "Physical Growth and School Progress," *Bureau of Education Bulletin*, No. 581, 1914. In the text I have taken round figures as rough standards, and, as for height and weight, so for puberty, I have taken a deviation of about two years as a crude conventional limit for normal variation. But again, for

a more laborious undertaking. Tests of emotional and moral qualities will require much further refinement before it will be worth while to compile standardized norms by their use. A collection of concrete character studies—detailed descriptions of representative personalities of either sex, of every type, and of each succeeding year of child life—would probably be of far greater service.

How the investigation of delinquency itself may best proceed I have sought to show in this volume. The methods of inquiry, in their broad outlines, have proved themselves to be both feasible and effective: the conclusions reached, however, as I have continually insisted, can be taken as no more than tentative. One investigator single-handed can never collect the requisite material. He may, indeed, see a thousand cases in the course of twelve months; but he cannot, even in the space of as many years, make any exhaustive study of more than a few small groups. Where the conditions at work are so complex, where individual variations are so wide and so erratic, and where the probable errors are so high, results deduced from a few hundred cases can have but an approximate value. A well-equipped clinic, with a staff of workers, each trained scientifically in some special aspect of the problem, ought gradually to amass statistics upon an extensive scale and carry out intensive studies of individual cases followed up over a long period of years. Then at last, when sound conclusions have been reached, when the causes of crime are more thoroughly understood, and the most successful ways of treating each type or class have been demonstrated by the after-histories obtained, preventive efforts and remedial measures will become as easy and as sure as at present they are clumsy and uncertain.

In this country the prisons alone cost over £1,000,000 a year.<sup>11</sup> The cost of apprehending and trying each offender, together with

---

reasons referred to in the text (page 202, footnote 6), small importance can be attached to the percentages given in Table XII for non-delinquents.

In assessing physiological development, besides pubescence, the age of walking and the age at which the various teeth, temporary and permanent, have emerged are often points of interest. Measures of variability, however, are again needed. See R. B. Bean, "Eruption of Teeth as a Physiological Standard for Testing Development," *Ped. Sem.* V (1914), No. iv. A rough but useful table of average ages, both for dentition and for head and chest measurements, is to be found in A. F. Tredgold's *Mental Deficiency* (2nd ed., pp. 466-7: those who are not teachers should note that the ages there given for school standards are very wide of the true mark—the error being in some cases as much as two years).

<sup>11</sup> The total annual cost of prisons (local, convict, and preventive detention) together with Borstal institutions, is £1,011,288, or £62 5s.



the amount of damage he does before he is apprehended, adds an incalculable amount to this vast sum. Plainly, the expense of psychological clinics such as I have just described would be covered over and over again by the saving they would eventually achieve, and the gain in human happiness, in social and industrial efficiency, and in the moral welfare of the community as a whole would be beyond all computation.

---

per inmate (*Report of Commissioners, 1923, p. 95*). The annual cost of London industrial schools is £73,753, or nearly £100 per inmate (*London Statistics, 1921-3, p. 199*).



## APPENDIX III

### SELECTED REFERENCES

THE following list of books may be of service to those who are commencing a study of the psychology of the young delinquent. In regard to the study of particular problems the references given in the footnotes to the several chapters will usually be sufficient to direct the reader to the more important contributions. On the general subject of crime the most complete bibliography is that contained in the *List of Works relating to Criminology* (New York Public Library, 1911, pp. 362). Healy's main work contains a bibliography of over 300 numbers, concerned chiefly with the psychological aspect.

- HEALY, William. *The Individual Delinquent*. Boston: Little, Brown & Co. 1915. Pp. 830. \$5.00.
- HEALY, William. *Mental Conflicts and Misconduct*. Boston: Little, Brown & Co. 1917. Pp. 330. \$2.50.
- HEALY, William. *Honesty: A Study of the Causes and Treatment of Dishonesty among Children* (Childhood and Youth Series). Indianapolis: The Bobbs Merrill Co. 1915. Pp. 220. \$1.00.
- HEALY, William, and BRONNER, A. F. *Judge Baker Foundation Case Studies*, Nos. 1-20. Boston: Judge Baker Foundation. 1923. Pp. 630. \$2.50.
- ELLIS, Havelock. *The Criminal* (4th ed.) (Contemporary Science Series). New York: Charles Scribner's Sons. 1913. Pp. 440. \$1.50.
- ASCHAFFENBURG, G. *Crime and its Repression* (Modern Criminal Science Series). Boston: Little, Brown & Co. 1913. Pp. 331. \$4.00.
- GROSS, Hans. *Criminal Psychology* (Modern Criminal Science Series). Boston: Little, Brown & Co. 1911. Pp. 514. \$5.00.
- SMITH, M. Hamblin. *The Psychology of the Criminal*. New York: Robert M. McBride. 1923. Pp. 182. \$2.00.
- SULLIVAN, W. C. *Crime and Insanity*. London: Edward Arnold. 1924. Pp. viii + 259. 12s. 6d.
- GORING, Charles. *The English Convict* (Abridged Edition: with Introduction by Karl Pearson). London: H. M. Stationery Office. 1919. Pp. 275. 3s.

- MORRISON, W. D. *Juvenile Offenders*. London: T. Fisher Unwin. 1910. Pp. 317. 3s. 6d.
- GODDARD, H. H. *Juvenile Delinquency*. New York: Dodd, Mead & Co. 1923. Pp. 120. \$1.50.
- KELLEY, Truman L. *Mental Aspects of Delinquency*. Austin: University of Texas. 1917. Pp. 125. 50 cents.
- WILLIAMS, J. Harold. *The Intelligence of the Delinquent Boy* (*Journal of Delinquency* Monographs, No. 1). Whittier, Cal.: Whittier State School Research Department. 1919. Pp. 198. \$1.00.
- BRONNER, Augusta F. *A Comparative Study of the Intelligence of Delinquent Girls*. New York: Columbia University Press. 1914. Pp. 95. \$1.00.
- WEIDENSALL, Jean. *The Mentality of the Criminal Woman* (Educational Psychological Monographs). Baltimore: Warwick & York Inc. 1916. Pp. xx + 332. \$1.75.
- FERNALD, M. R., HAYES, M. H. S., and DAWLEY, A. *A Study of Women Delinquents in New York State*. New York: The Century Company. 1920. Pp. xviii + 542. \$5.00.
- MATEER, Florence. *The Unstable Child*. New York: D. Appleton & Co. 1924. Pp. xiii + 471. \$2.75.
- SPAULDING, Edith R. *An Experimental Study of Psychopathic Women* (Publications of the U. S. Bureau of Social Hygiene). Chicago: Rand, McNally & Co. 1923. Pp. xvi + 368. \$2.50.
- SCHOFF, Hannah K. *The Wayward Child: A Study of the Causes of Crime* (Childhood and Youth Series). Indianapolis: The Bobbs-Merrill Co. 1915. Pp. 267. \$1.00.
- BRECKINRIDGE, S. P., and ABBOTT, E. *The Delinquent Child and the Home*. New York: Russell Sage Foundation. 1912. Pp. x + 355. \$2.00.
- RICHMOND, Mary E. *Social Diagnosis*. New York: Russell Sage Foundation, 1917. Pp. 511. \$2.00.
- RUSSELL, C. E. B., and RIGBY, Lillian M. *The Making of the Criminal*. The Macmillan Co. 1906. Pp. xvi + 362. \$1.25.
- BARNETT, Mary. *Young Delinquents: A Study of Reformatory and Industrial Schools*. New York: E. P. Dutton & Co. 1913. Pp. 222. \$1.25.
- FLEXNER, B., and BALDWIN, R. N. *Juvenile Courts and Probation*. New York: The Century Company. 1914. Pp. xii + 308. \$2.00.
- LEESON, C. *The Probation System*. London: P. S. King & Son. 1914. Pp. ix + 191. 4s.
- HALL, W. Clarke. *The State and the Child* (New Commonwealth Books). New York: Frederick A. Stokes Co. 1918. Pp. 195. \$1.00.

- GARNETT, W. H. S. *Children and the Law*. London: John Murray. 1911. Pp. xxiv + 292. 2s. 6d.
- HALL, W. Clarke, and PRETTY, A. H. F. *The Children Act, 1908* (Third Edition of *The Law Relating to the Child*). London: Stevens & Sons. 1909. Pp. xx + 240. 6s.
- Board of Education. Juvenile Organizations Committee. *Report on Juvenile Delinquency*. London: H.M. Stationery Office. 1920. Pp. 41. 9d.
- Scottish National Council of Juvenile Organizations. *Reports of an Inquiry into Juvenile Delinquency*. H.M. Stationery Office. 1923. Pp. 43. 9d.

### General Psychology

- MCDUGALL, William. *An Outline of Psychology*. New York: Charles Scribner's Sons. 1923. Pp. 456. \$2.50.
- WOODWORTH, R. S. *Psychology: A Study of Mental Life*. New York: Henry Holt & Co. 1922. Pp. 580. \$3.00.
- MCDUGALL, William. *Introduction to Social Psychology* (16th ed.). Boston: J. W. Luce & Co. 1921. Pp. xxiv + 459. \$1.75.
- SHAND, A. F. *The Foundations of Character* (2nd ed.). New York: The Macmillan Co. 1920. Pp. xxxvi + 578. \$5.50.
- HALL, Stanley G. *Adolescence*. New York: D. Appleton & Co. 1905. 2 vols. Pp. 589, 784. \$10.00.
- FLÜGEL, J. C. *The Psycho-Analytic Study of the Family*. London: Hogarth Press. 1921. Pp. 259. 10s. 6d.

### Periodical Publications

- The Reports of the Commissioners of Prisons* (H.M. Stationery Office). Annually. 1s. 6d.
- Judicial Statistics: England and Wales* (H.M. Stationery Office). Annually. 1s. 6d.
- Home Office Reports on the Work of the Children's Branch* (H.M. Stationery Office). Annually. 2s.
- The Journal of Delinquency* (Whittier State School, Department of Research, Whittier, California). Bi-monthly. \$1.25 per annum.
- The Journal of Criminal Law and Criminology* (American Institute of Criminal Law and Criminology, 31 West Lake St., Chicago). Bi-monthly. \$3.00 per annum.
- The British Journal of Medical Psychology* (Cambridge University Press, Fetter Lane, London, E.C.4.) Quarterly. 30s. per annum.

*The Psychological Clinic.* The Psychological Clinic Press (Woodland Ave., Philadelphia, Pa.). Monthly (nine issues). \$1.50 per annum.

*Mental Hygiene* (National Committee for Mental Hygiene. 27 Columbia Street, Albany, N. Y.). Quarterly. \$2.00 per annum.

More popular articles, dealing largely with questions of administration and treatment, may be found from time to time in the journal and other publications of the Howard League for Penal Reform (18, Savoy Street, London, W.C.2), and in such periodicals as *The Magistrate*, *The Certified Schools Gazette*, the journal of *The National Association of Probation Officers*, and the reports of the *International Prison Congress*, the *International Association for the Promotion of Child Welfare*, and the *International Moral Education Congress*.





## INDEX OF AUTHORS

- Abbott, E., 21, 66, 98, 436, 605.  
 Adler, A., 462.  
 Allport, G. W., 397.  
 Amsden, G. S., 397.  
 Anderson, V. V., 592.  
 Ardill, G. E., 191.  
 Aristotle, 279, 445, 479, 531.  
 Aschaffenburg, G., 46, 154, 604.  
 Auden, G. A., 258.  
  
 Bacon, F., 1, 399.  
 Bain, A., 451.  
 Baldwin, B. T., 601.  
 Baldwin, R. N., 184, 605.  
 Ballard, P. B., 281, 499, 599.  
 Barnett, M., 605.  
 Barr, M. W., 34, 41.  
 Bean, R. B., 602.  
 Berman, L., 395.  
 Beven, T., 422.  
 Binet, A., 37, 202, 286, 348, 367,  
     391, 455, 493, 510.  
 Blackstone, W., 16.  
 Booth, C., 65-6, 68, 73, 449.  
 Bowley, A. L., 64, 84.  
 Breckinridge, S. P., 21, 66, 98, 436,  
     605.  
 Brockway, A. F., 224.  
 Bronner, A., 109, 285, 330, 334, 604,  
     605.  
 Browning, R., 199, 339, 377.  
 Bryant, E. K., 493.  
 Burke, C. F., 429.  
 Burnett-Hurst, A. R., 64, 84.  
 Burns, R., 196.  
 Byron, N. G., 484, 538, 574.  
  
 Cady, V. S., 388, 393, 395, 400.  
 Carlyle, T., 416.  
 Chambers, O. R., 387.  
 Clark, W. W., 13.  
 Clouston, T. S., 35.  
 Crampton, W. C., 601.  
 Crosland, E., vii.  
  
 Dante, 335.  
 Darwin, C., 379, 395, 450.  
 Davenport, C. B., 44, 54, 436.  
 Dawley, A., 605.  
 Defoe, D., 277.  
 Delbrück, A., 366.  
 De Quincey, T., 461.  
 Descartes, R., 444.  
 Dewey, J., 33, 395, 407.  
 Dickens, C., 40, 44, 69.  
 Dickinson, J., 117.  
 Dostoiévsky, F., 461, 469.  
 Downey, J. E., 386, 391, 599.  
 Doyle, A. C., 328.  
 Drever, J., 406, 407, 408, 426, 433,  
     460.  
 Dugdale, R. L., 44.  
 Dupouy, E., 440.  
 Durkheim, E., 167.  
 Dyer, C., 16.  
  
 East, E. N., 167, 288, 462.  
 Eastabrook, R., 44.  
 Elderton, E., 96.  
 Ellis, H., 38-9, 41, 44, 118, 166,  
     453, 510, 604.  
 Faris, E., 407.  
 Fenero, G., 38, 57.  
 Fernald, M. R. H., 388, 391, 605.  
 Field, J., 16.  
 Findlay, J. J., 196.  
 Fitzherbert, A., 422.  
 Flexner, A., 184, 605.  
 Flügel, J. C., vii, 388, 525, 528,  
     606.  
 Fox, E., vii.  
 France, A., 587.  
 Freud, S., 414, 423, 453, 462, 510,  
     534, 545, 556, 563.  
 Fry, M., vii, 597.  
  
 Galen, C., 235, 493.  
 Galton, F., 44, 118, 201, 384.

- Garnett, W. H. S., 605.  
 Gaupp, R., 461.  
 Gaw, F., 598.  
 Gay, J., 277, 448.  
 Giles, A. E., 218.  
 Glen, R., 259, 262.  
 Glueck, B., 266-7.  
 Goddard, H. H., 44, 267, 285, 485,  
     570, 605.  
 Gordon, A. L., 458.  
 Goring, C., 54, 200-1, 210, 284,  
     604.  
 Gosse, E., 380.  
 Greenwood, M., 201.  
 Grohmann, J. C. A., 35.  
 Gross, H., 604.  
 Guthrie, L. G., 366, 465.  
  
 Hamer, T. H., 388.  
 Hale, M., 16, 17, 29, 422.  
 Hall, A. J., 259.  
 Hall, G. S., 211, 214, 429, 436,  
     449, 472, 476, 479, 482, 606.  
 Hall, W. C., 20, 109, 119, 156,  
     228-9, 251, 605, 606.  
 Hart, B., 545.  
 Hayer, M. H. S., 605.  
 Hayner, H. A., 196.  
 Hazlitt, W. C., 39-40.  
 Healy, M. F., 366.  
 Healy, W., 21, 41, 66, 96, 109, 144,  
     171, 179, 203, 209, 222, 234,  
     258, 267, 274, 284, 306, 334,  
     366, 367, 381, 390, 417, 455,  
     533, 539, 562, 569, 571, 574,  
     581, 592, 604.  
 Heine, H., 339.  
 Heinroth, J. C. F. A., 35.  
 Hesiod, 157.  
 Hiatt, J. S., 436.  
 Hippocrates, 79.  
 Hoare, F. R., 230.  
 Hobbes, T., 31.  
 Hobhouse, S., 224.  
 Hoch, A., 397.  
 Hoepner, T., 275.  
 Hollingworth, H. L., 400.  
 Homer, 279.  
 Horace, 254, 456, 490.  
 Hug-Hellmuth, H. von, 545.  
 Hughes, C., 397.  
  
 Hutcheson, F., 36.  
  
 Irwin, E. A., 436.  
  
 James, H., 272, 545.  
 James, W., 352, 406, 423, 426, 433,  
     493.  
 Joffroy, A., 440.  
 Johnson, S., 238, 246, 356, 396, 560.  
 Jones, E., 214, 381, 545, 573.  
 Jung, C. G., 384-5, 493.  
 Justinian, 16.  
  
 Kelley, T. L., 21, 285, 605.  
 Kent, G. H., 384-5.  
 Kipling, R., 173, 347, 453.  
 Klein, M., 545.  
 Kline, T. W., 436, 475.  
 Koch, J. L. A., 571.  
 Kohs, S. C., 285, 390.  
 Krafft-Ebing, R. U., 35.  
  
 Landor, W. S., 277.  
 La Rochefoucauld, F. de, 242, 454,  
     502.  
 Leeson, C., 152, 184, 605.  
 Lenroot, K. F., 90.  
 Lickley, E. J., 436.  
 Linnæus, C., 212.  
 Locke, J., 32, 550.  
 Lombroso, C., 38, 57, 200, 209, 256.  
 Low, B., 381.  
 Lundberg, E. O., 90.  
  
 McDougall, W., 33, 214, 383, 400,  
     406, 407, 408, 426, 433, 444, 456,  
     461, 479, 537, 552, 606.  
 Mackenzie, J. S., 33.  
 Malebranche, N. de, 382.  
 Maloney, E. F., 34, 41.  
 Marie, A., 440.  
 Marquis, F. J., 150.  
 Mateer, F., 485, 570, 573, 605.  
 Maudsley, H., 34, 35, 38.  
 Menander, 123.  
 Mercier, C., 30, 31, 35, 116.  
 Meredith, G., 235, 333.  
 Mérimée, P., 520.  
 Meunier, R., 440.  
 Meyer, A., 266, 571.  
 Miller, H. C., 380.

- Miner, J. B., 285.  
 Montesquieu, C. de S. de, 118.  
 Montessori, M., 342, 380, 497.  
 Moore, H. I., 384, 392.  
 Moore, R. C., 385, 470.  
 Morel, B. A., 37.  
 Morrison, W. D., 66, 203, 209, 605.  
 Morselli, E., 167, 461.  
 Moss, M., vii.  
 Musset de, L. C. A., 520.  
 Myers, C. S., vii.  
 Myerson, A., 387.  
  
 Nunn, T. P., 474.  
  
 Paterson, A., 90, 224.  
 Paterson, D., 258.  
 Pear, T. H., 524.  
 Pearson, K., 46, 159, 210.  
 Pfister, O., 510.  
 Pinel, P., 33.  
 Plato, 479.  
 Plaut, P., 267.  
 Pope, A., 205, 246, 515.  
 Porteus, S. D., 392.  
 Potts, W. A., 42, 593.  
 Pressey, S. L., 387.  
 Pretty, A. H. F., 606.  
 Prideaux, E., 385.  
 Pritchard, J. C., 33, 35.  
  
 Quirós de, C. B., 116.  
  
 Raubenheimer, A. S., 393, 599.  
 Reaney, M. J., 447.  
 Richmond, M. E., 120, 605.  
 Rigby, L. M., 605.  
 Rivers, W. H. R., 426, 563.  
 Rollinat, M., 555.  
 Rosanoff, A., 384-5.  
 Rousseau, J. J., 498, 499, 550.  
 Rouvier, M., 597.  
 Rowntree, S., 64, 65, 84.  
 Rückert, F., 60.  
 Rugg, H. O., 399.  
 Russell, C. E. B., 605.  
  
 Salter, M. de C. S., 156.  
 Schoff, H. K., 605.  
 Scott, W. D., 399.  
 Seneca, 90, 451, 479.  
  
 Shaftsbury, A. A. C., 31-2.  
 Shakespeare, W., 28, 89, 200, 351,  
 451, 570.  
 Shand, A. F., 382, 400, 406, 408,  
 423, 451, 461, 606.  
 Sharp, F. C., 390.  
 Shaw, G. B., 120, 340.  
 Sheldon, H. D., 447.  
 Shideler, E. H., 98.  
 Shruballs, F. C., 30, 251, 258, 291,  
 295.  
 Simon, T. *See* Binet, A.  
 Smedley, F., 601.  
 Smith, A., 460.  
 Smith, M. H., 545, 593, 604.  
 Smith, S., 154.  
 Smith, W. W., 385.  
 Spaulding, E. R., 495, 570, 573, 605.  
 Spearman, C., 397.  
 Spencer, H., 246, 499.  
 Spielman, M. A., 105.  
 Stelzner, H., 571.  
 Stein, W., 367.  
 Stevenson, R. L., 89, 134, 246, 439,  
 465.  
 Stoddart, W. H. B., 294.  
 Sullivan, W. C., 36, 37, 604.  
  
 Talbot, E. S., 37.  
 Taylor, A. E., 33.  
 Taylor, J., 233.  
 Tennyson, A., 38, 434, 562.  
 Terman, L. M., 388, 393, 397, 461.  
 Thomas, W. I., 482.  
 Thompson, R., 210.  
 Thorndike, E. L., 399, 407.  
 Thrale, H. L., 396, 397.  
 Thurstone, L. L., 196.  
 Tissot, P. F., 212.  
 Tredgold, A. F., 34, 35, 36, 41, 571,  
 602.  
 Trotter, W., 534.  
 Trought, T. W., vii, 143.  
 Tufts, J. H., 33.  
 Tuke, H., 35.  
  
 Villon, F., 89.  
 Voelker, P. F., 392.  
  
 Wainwright, T., 39-40.  
 Webb, E. E., 397.

- Weidensall, J., 605.  
Wells, H. G., 538.  
Wertheimer, M., 384.  
Whipple, G. M., 351, 367, 599,  
601.  
Wilde, O., 39, 40.
- Williams, J. H., 21, 98, 285, 437,  
605.  
Williams, W. R., 218.  
Woodworth, R. S., 387, 606.  
Wordsworth, W., 350.  
Yerkes, R. M., 397.

## INDEX OF SUBJECTS

- Abilities. *See* Special abilities.  
Ability. *See* General intelligence.  
Abnormal emotionality, defined, 405.  
Abnormalities, physical. *See* Physical condition.  
Absconding, 457.  
Acquisitiveness, 15, 49, 426-33, 474-6. *See also* Theft.  
Act, Children, 15, 17, 99, 101, 102, 103, 105, 106, 181.  
Children (employment abroad), 172.  
Choice of employment, 194.  
Criminal jurisdiction amendment, 187.  
Criminal justice administration, 183, 225, 231.  
Education, 172.  
Education (provision of meals), 79.  
Elementary education (defective and epileptic children), 286, 317.  
Employment of children, 172.  
First offenders, 183.  
Industrial schools, 105.  
Juvenile offenders, 16.  
Mental deficiency, 29, 58, 300, 304, 317.  
Prevention of crime, 224.  
Summary jurisdiction, 16.  
*See also* Criminal justice bill.  
Adenoids, 239, 240, 243.  
Adolescence, 17, 206-20, 222, 232-5, 567, 582, 585, 601.  
Adolescent instability, 490, 491.  
Affection, 459-61, 487.  
After-care, after-results, after-study. *See* Following up.  
Alcoholism, 49, 61, 96-7, 147-8, 409.  
Amnesia, 439. *See also* Hysteria.  
Amusement, defective facilities for, 149-51.  
Excessive facilities for, 71, 134-49.  
Anger, 15, 415-26, 451, 479-80, 485, 589. *See also* Damage, Temper, and Violence.  
Anxiety neurosis, 468.  
Anxiety states, 462, 557-8.  
Appearance, 275, 277. *See also* Physiognomy.  
Appetites, 408.  
Arson, 418. *See also* Damage.  
Association, coefficients of, defined, 52.  
Mental, 384, 505, 515.  
Association tests. *See* Tests.  
Attainments. *See* Educational attainments.  
Auto-erotism, 541.  
Automatism, 440, 566.  
Backwardness, 20, 48, 287, 321-34, 581.  
Defined, 287, 308, 322.  
Bad language, 14, 418.  
Begging, 15, 132, 135, 147, 364.  
Betting, 144-6, 182.  
Binet tests. *See* Tests of intelligence.  
Biography. *See* Case-history.  
Birching. *See* Corporal punishment.  
Boarding out, 109.  
Born offender, 28, 38-9.  
Boroughs. *See* Local distribution.  
Borstal institutions, 16, 224-7, 457.  
Boy Scouts, 190.  
Bullying. *See* Cruelty.  
Burglary. *See also* Theft.  
Case committee, 8, 122.  
Case histories, 5-11, 22. *See also* Methods.  
Cases, Grace A., 45.  
Arthur B., 76-9.



- Tommy B., 76-9.  
 Rose C., 81-4.  
 Edith D., 126-9.  
 Johnny E., 131-4, 206, 276, 438.  
 Maisie F., 135-7, 354-5.  
 Martin G., 175-7, 561.  
 Maggie H., 204-6.  
 Olive I., 244-7.  
 Henry Jacoby, 422.  
 Ellen J., 466.  
 Harold J., 288-9, 428.  
 Harold Jones, 422.  
 Jerry Jones, 1-4, 6-10, 12, 28, 42, 44, 485-90.  
 Tommy K., 288-91.  
 Vivian L., 310-12.  
 Jim M., 312-16, 467.  
 Nellie Malone, 356-9, 517, 524, 535.  
 Robert N., 324-8, 349.  
 May Naylor, 369-75.  
 "Nipper," 335-40.  
 Emmeline O., 410-13.  
 Irene P., 424-6.  
 Stanley Q., 441-4.  
 Violet R., 462-4.  
 Flora S., 563-9.  
 Marie Schneider, 41.  
 B. I, B. II, C. I, C. II, 589-90.  
 Anonymous, 45, 139, 140, 291-2, 439, 455, 465, 468, 532.
- Catarrah, 239.  
 Causal types, 11.  
 Causation, 5, 574-83.  
 Central Association for Mental Welfare, 302.  
 Central school children, 282.  
 Character. *See* Temperament.  
 Cheating, 245, 323.  
 Child, defined, 16.  
 Chorea, 48, 240, 260-1, 368.  
 Cinema, 137-43, 298, 521, 582.  
 Clubs, 190-1, 195, 233, 480.  
 Coefficients. *See* Association and Correlation.  
 Collecting. *See* Acquisitiveness.  
 Colonies, juvenile, 227-30, 342.  
 Companions, 123-34, 191-2, 582.  
 Compensation, 368, 450, 461.  
 Complex, defined, 515, 524.  
 Complexes, 175, 244, 336, 357, 425, 442, 461, 515-54, 576, 581, 582.  
 Compulsion neurosis, 175, 560-2.  
 Conceptions, 160, 165, 166.  
 Confession, 377-8, 553-4.  
 Conflict, mental, 529-34, 562.  
 Congenital factors, 28-59, 281, 400-1, 577-83. *See also* Heredity.  
 Constructive efforts, 483, 550-2.  
 Contra-suggestibility. *See* Self-assertion.  
 Control group, 13, 61.  
 Convalescence, 246-7, 253.  
 Conviction, 108, 180-1.  
 Corporal punishment, 115-19. *See also* Punishment.  
 Correlation, coefficients of, defined, 52.  
 Correlations, 51, 73, 152, 394.  
 Country life, 253-4, 496-7.  
 Courts. *See* Juvenile courts.  
 Crime. *See* Delinquency.  
 Criminal Justice Bill, 111, 112, 183-4.  
 Criminological department, 185.  
 Cruelty, 15, 49, 117, 297, 417, 451-3.  
 Curiosity, 444-5, 451.
- Damage, 15, 165, 297, 418, 422.  
 Dance halls, 147-8.  
 Day-dreaming, 244, 355-9, 360, 362, 442, 525.  
 Day industrial schools, 435, 477.  
 Deafness. *See* Hearing.  
 Defectives. *See* Mental Deficiency.  
 Degeneracy, 36-38, 570, 597.  
 Delinquency, causes. *See* Table of Contents.  
 Defined, 13-15. *See also* Offenses.  
 Index of, 14.  
*See* Treatment.  
 Delinquents. *See* Cases.  
 Delusions, 366.  
 Dementia praecox. *See* Psychosis.  
 Destruction. *See* Damage.  
 Detective stories, 137.  
 Deterrence, 456. *See also* Punishment.  
 Development, physical, 200-37, 275, 599-600.

- Diet, 167.
- Discipline, 92-5, 254-5, 497-9, 581
- Disease, 238-75.
- Disgust, 407, 458-9, 527.
- Dissociation, 372, 559.
- Drugs, 241, 264, 366.
- Drunkenness. *See* Alcoholism.
- Dullness, 48, 282, 287, 307-21, 581.  
Defined, 287, 308.
- Educational attainments, 23, 307-8, 590. *See also* Backwardness.
- Educational tests. *See* Tests, scholastic.
- Electoral areas. *See* Local Distribution.
- Emotion, defined, 404.
- Emotion. *See* Temperament and Instincts.
- Employment, lack of, 169-71, 187, 203, 243.  
Uncongenial, 172-3, 193-4.
- Encephalitis, 240, 258-66, 417.
- Environment, 7, 60-198, 577-83.
- Epilepsy, 48, 240, 256-66, 368, 417, 439, 441, 564.
- Eugenics, 57-8, 306-7, 587.
- Excretion, 407, 459.
- Exercise, 500.
- Exhibitionism, 415.
- Exposure, 14.
- Extrovert, 493.
- Family history, 23, 28. *See also* Heredity.
- Family life, 344. *See also* Home conditions.
- Fantasia. *See* Day-dreaming.
- Fear, 364, 456-8, 486-7.
- Fines, 115, 182, 231-2.
- First offenders, 212.
- Following up, 9-11, 185, 583.
- Forgery, 15, 341.
- Foster homes, 110.
- Fraud, 292, 338.
- Frequency ratio, 53.
- Friendships. *See* Companions.
- Fugues, 439.
- Gambling, 144-6, 182, 448, 521.
- Gangs, 189, 446-9, 480-2.
- General emotionality, 404-5, 484-503.
- General intelligence, 23, 281-321, 484, 589.  
Defined, 281.
- Genius. *See* Supernormal.
- Glands, internal, 209, 221.
- Gluttony. *See* Hunger.
- Graded exercises, 512-13.
- Gregariousness, 480-2. *See also* Herd instinct.
- Grief, 15, 461-8, 489.
- Group factors. *See* Specific factors.
- Grudge formation, 244, 527. *See also* Complexes.
- Guardianship, 305, 318-19.
- Habits, 501-2, 503-19.
- Habitual offenders, 209.
- Hatred, 418.
- Headache, 240.
- Head injury, 264-6.
- Health. *See* Disease.
- Hearing, 240, 273-5.
- Hedonism, 471.
- Herd instinct, 445-9, 488.
- Heredity, 28-59, 60-1, 400, 577-83.
- Home conditions, 22-3, 60-122, 178-80.
- Homosexual practices, 415, 448.
- Hostels, 304-5, 319.
- Hunger, 408, 530.
- Hunting, 433-5, 451, 500.
- Hypnosis, 372, 455, 566.
- Hysteria, 363, 368, 372, 439, 549, 562-9.  
Defined, 562-3.
- Ideals. *See* Sentiments.
- Idleness, 49, 169-71.
- Illegitimacy, 90, 543.
- Illiteracy. *See* Backwardness.
- Imagery, 138, 350-6, 360-1.
- Imitation, 138.
- Impulsive insanity, 560.
- Inborn characteristics, 400, 577-83.  
*See also* Heredity.
- Incontinence, 269, 407, 408, 415, 486, 528.
- Incorrigibility, 15, 417.

- Industrial schools, 17, 18, 105-9, 254, 263, 304, 319-20, 331, 346, 514.
- Inferiority complex, 244, 419, 536-7.
- Inheritance. *See* Heredity.
- Insanity, 35, 49, 167, 293, 366. *See also* Psychosis.
- Instability, 42, 295, 330, 484-503, 570, 581.  
Defined, 485, 491.
- Instinct, criteria, 408.  
Defined, 402.
- Instincts, 402-83. *See also* Temperament.  
Asthenic, 470, 483, 492.  
Sthenic, 470, 492.
- Institutions, 191-2, 303-4, 494, 571-2, 586, 597. *See also* Industrial schools and Reformatories.
- Intellectual conditions, 279-381.
- Intelligence. *See* General intelligence.
- Interests, 333-4. *See also* Sentiments.
- Interviews, 396-9.
- Introvert, 442, 493, 532-3.
- Irritation, local, 240, 268-9.
- Jealousy, 421, 467, 543.
- Joy, 468-9.
- Juvenile, defined, 15-17.
- Juvenile adult, defined, 15.
- Juvenile courts, 17, 19, 185.
- Key subjects. *See* Standard personalities.
- Kleptomania. *See* Theft.
- Latent period, 414, 549.
- Leisure. *See* Amusement.
- Letters, 315, 369, 370, 590-1.
- Literature, pernicious, 137.
- Little commonwealth, 108.
- Local distribution of delinquency, 67-76, 134.
- Lying, 15, 128, 132, 361-81, 457-8.
- Major factors, defined, 575-6.
- Manias, 560.
- Marks. *See* Scale.
- Masturbation, 14, 269, 371, 415.
- Material analyzed, 11, 17.
- Medical examination, 199, 247-53.
- Melancholia. *See* Grief.
- Mendelism, 43.
- Meningitis, 240, 259, 366.
- Menstruation, 409. *See also* Puberty.
- Mental age, 281, 283-4.
- Mental deficiency, 17, 20, 39, 48, 284-307.  
Defined, 286, 288.
- Mental hospital, 261.
- Mental ratio, 307, 322.  
Defined, 283.
- Methods, 5-11, 545-50, 597-600.  
Experimental. *See* Tests.  
Observational, 395-6.
- Migration, 49.
- Molestation, sexual, 125, 131.
- Monthly variations. *See* Seasonal variations.
- Moral deficiency. *See* Moral imbecility.
- Moral degeneracy. *See* Degeneracy.
- Moral imbecility, 29, 34-6, 38, 494, 571, 585.  
Defined, 29.
- Moral insanity, 33.
- Moral sense, 31, 33.
- Murder, 1, 15, 39, 41, 422-3.
- Music, 500-11.
- Music hall, 148.
- Narcissism, 175, 536, 542.
- National Institute of Industrial Psychology, 595, 599.
- Nervous disorders, 256-66, 555-73.
- Neurasthenia, 557.
- Neuroses, 555-73.
- Neurosis, defined, 556.
- Night clubs, 148.
- Obscenity. *See* Bad language.
- Obsessions, 138, 176, 355, 487, 558-9.
- Offenses, 13, 14-15. *See also* Begging, Betting, Cruelty, Damage, Forgery, Gambling, Lying,

- Murder, Prostitution, Sex offenses, Suicide, Swingling, Violence, Wandering.
- Orphans, 76-9. *See also* Home conditions.
- Overcrowding, 75, 84-6.  
Defined, 84.
- Ownership, 475.
- Pain, 407, 469, 472, 504.
- Parents, 516, 523. *See also* Family life and Home conditions.
- Passions. *See* Sentiments.
- Pathological conditions, physical.  
*See* Disease.  
Mental. *See* Psychopathic and Psychosis.
- Pathological lying. *See* Lying.
- Pathological stealing, 560.
- Pedigrees, 43-7.
- Penalties. *See* Punishment.
- Percentile, 398, 601.
- Periodicity. *See* Puberty.
- Physical conditions, 23, 200-78, 323, 417. *See also* Development and Disease.
- Physiognomy, 395, 589.
- Place of offenses, 151. *See also* Local distribution.
- Places of detention, 18, 102-5, 592, 595.
- Play, 469, 500. *See also* Amusement.
- Pleasure, 469, 473, 478, 504, 511.
- Poverty, 62-90.  
Defined, 64.
- Prison, 101-2, 230-1.
- Probation, 115-22, 183-9, 586.
- Probation officers, 172, 553.
- Prostitution, 14, 130, 136, 147, 589.  
*See also* Sex offenses.
- Psychoanalysis, 9, 330, 473-4, 515, 541, 544, 573.  
Defined, 546.
- Psycho-galvanic reaction, 384.
- Psychological clinic, 104, 251, 299, 586, 591-5.
- Psychological examination, 5, 7, 299, 592.
- Psychopathic, 47, 49, 595.  
Defined, 569-70.
- Psychosis, 569. *See also* Insanity.
- Psychotherapy, 572-3. *See also* Psychoanalysis.
- Puberty, 369, 601. *See also* Adolescence.
- Public houses, 147.
- Punishment, 456, 504, 512.
- Race differences, 408, 409, 416, 426, 436.
- Rain. *See* Weather.
- Rating. *See* Scale.
- Reading, 43, 325.
- Receivers, 130.
- Recognizances, 115, 182.
- Record form. *See* Schedule.
- Recreation, 24, 71, 86-8, 194-6, 233, 500-1. *See also* Amusements.
- Reëducation, 550-2.
- Reformatories, 107-9, 346.
- Religion, 219, 235-7, 381, 538.
- Remand homes. *See* Places of detention.
- Removal from home, 101-13, 189-90.
- Repentance, 468-9.
- Report, 367.
- Repression, 368, 461, 473, 493, 497-8, 523, 530.
- Research, need for, 185.
- Residence, change of, 101-13, 189-90.
- Residential centers, 597.
- Rewards, 511.
- Rheumatism, 48, 240, 244.
- Riverside village. *See* Sysonby.
- Running away, 16, 311, 368. *See also* Wandering.
- Scale, 398. *See also* Tests of intelligence.
- Schedule of inquiry, 22-5.
- Scholarship children, 282.
- School, 173-4, 177-8, 192-3, 343-4, 479.
- School attainments. *See* Educational attainments.
- Seasonal variations, 153-69.
- Secretiveness, 16, 428, 457.
- Segregation, 58, 233-5, 317-18, 494-5, 514.

- Self-abuse. *See* Masturbation.
- Self-assertion, 363, 449-53, 486, 536.
- Self-display. *See* Self-assertion.
- Selfishness, 460.
- Self-submission, 454-6.
- Sentiment, defined, 515.
- Sentiments, 515-54.
- Sex differences, 21, 92, 93, 130, 137, 147, 171, 413, 423-4, 447, 470-1, 539.
- Sex enlightenment, 482.
- Sex instincts, 235, 269, 403, 409-15, 482, 486, 520, 534, 549, 564. *See also* Puberty.
- Sex offenses, 15, 49, 165, 292, 306-7, 314. *See also* Masturbation, Prostitution, and Homosexual practices.
- Slums. *See* Poverty and Local distribution.
- Sociability. *See* Herd instinct.
- Social condition. *See* Environment.
- Social factors. *See* Companions, Gregarious instincts, Home environment.
- Soliciting, 15. *See also* Prostitution and Sex offenses.
- Special abilities, 24, 287, 295-6, 348-61.
- Special classes, 316-7, 330-1.
- Special disabilities, 287, 325.
- Special schools, 301.
- Specific factors, emotional, 470, 484-5, 492-3.  
Intellectual. *See* Special abilities and Special disabilities.
- Speech defects, 240, 274-5.
- Stammering. *See* Speech defects.
- Standard personalities, 400.
- Standard situation, 399.
- Stealing. *See* Theft.
- Step parents, 371.
- Sterilization, 306-7.
- Street life, 150-1. *See also* Environment.
- Sublimation, defined, 473-4.
- Submissiveness. *See* Self-submission.
- Substitutional delinquency, 430-1, 532.
- Suggestibility, 455, 564.
- Suicide, 16, 48, 168, 315, 467-8.
- Sunday schools, 153.
- Supernormal ability, 39-41, 335-48.
- Swindling, 16, 350, 364.
- Symbolism, 456, 461, 509-10, 535.
- Sympathy, 451, 460.
- Syphilis, 48, 240, 266-8, 564-5.
- Sysonby, 88, 108.
- Temper, 15, 49. *See also* Anger and Violence.
- Temperament, 25, 343, 382-503, 589.  
Defined, 382.
- Temperamental deficiency, 49.  
Defined, 491.
- Temperature. *See* Weather.
- Tenderness. *See* Affection.
- Tests, 6, 7, 19, 279-82, 286-8, 299, 323, 367, 384-400, 595, 598-9.  
Association, 548.  
Groups, 281-2, 598.  
Of emotion, 383-7.  
Of imagination, 351.  
Of intelligence, 76, 281, 284-5, 286-7, 300, 308, 598.  
Of learning, 514.  
Of morality, 388-95.  
Of reasoning, 599.  
Of report, 367, 380, 455.  
Of special abilities, 599.  
Of suggestibility, 455.  
Of testimony, 367.  
Performance, 598.  
Scholastic, 280-1, 307-8, 322.  
Temperamental, 599.  
Vocational, 599.  
Wassermann, 267.  
Will-temperament, 386.
- Theft, 15, 45, 49, 76, 77, 81-4, 126-30, 139, 162, 205, 245-6, 288, 298, 311, 325-6, 337, 353, 357, 474-6, 512-13, 560, 565, 589.  
*See also* Acquisitiveness.
- Thyroid, 48, 222, 240.
- Time of offenses, 151-69.
- Transference, 516, 541.
- Treatment, 26, 56-9, 97-121, 180-98, 220-37, 298-307, 328-33, 341-8,



- 359-61, 375-81, 471-83, 493-502,  
510-14, 545-54, 571-3, 583-7.
- Truancy, 2, 15, 290, 434, 435, 437,  
456, 476-9.
- Tuberculosis, 48, 240.
- Unconscious processes. *See* Re-  
pression.
- Unemotional, 312-16.
- Unemployment. *See* Employment,  
lack of.
- Unrepressed, 310-12.
- Unstable. *See* Instability.
- Unstable child. *See* Instability.
- Vagrancy. *See* Wandering.
- Vanity. *See* Self-assertiveness.
- Verbalism, 296, 349-50, 361.
- Vicious home, 95-7.
- Violence, 15, 167. *See also* Anger.
- Vision, 240, 244, 270-2.
- Vocational guidance, 193-4, 320-1,  
331-3, 345. *See also* Employ-  
ment, uncongenial.
- Voluntary cases, 112-13.
- Wandering, 15, 49, 165, 292, 297,  
357, 434, 435-44, 476-9.
- War, 91.
- Weather, 156-69, 436.
- Whipping. *See* Corporal punish-  
ment.
- Will, weakness of. *See* Self-sub-  
mission and Suggestibility.
- Will-temperament, 386.
- Young person, defined, 15.

1. The first part of the book is devoted to a general introduction to the subject of the history of the United States. It covers the period from the discovery of the continent to the present time.
2. The second part of the book is devoted to a detailed account of the early history of the United States. It covers the period from the first settlement of the continent to the end of the eighteenth century.
3. The third part of the book is devoted to a detailed account of the middle history of the United States. It covers the period from the beginning of the nineteenth century to the end of the Civil War.
4. The fourth part of the book is devoted to a detailed account of the late history of the United States. It covers the period from the end of the Civil War to the present time.
5. The fifth part of the book is devoted to a detailed account of the future of the United States. It covers the period from the present time to the end of the world.
6. The sixth part of the book is devoted to a detailed account of the present state of the United States. It covers the period from the present time to the present time.
7. The seventh part of the book is devoted to a detailed account of the past state of the United States. It covers the period from the past time to the past time.
8. The eighth part of the book is devoted to a detailed account of the future state of the United States. It covers the period from the future time to the future time.
9. The ninth part of the book is devoted to a detailed account of the present state of the world. It covers the period from the present time to the present time.
10. The tenth part of the book is devoted to a detailed account of the past state of the world. It covers the period from the past time to the past time.
11. The eleventh part of the book is devoted to a detailed account of the future state of the world. It covers the period from the future time to the future time.
12. The twelfth part of the book is devoted to a detailed account of the present state of the world. It covers the period from the present time to the present time.
13. The thirteenth part of the book is devoted to a detailed account of the past state of the world. It covers the period from the past time to the past time.
14. The fourteenth part of the book is devoted to a detailed account of the future state of the world. It covers the period from the future time to the future time.
15. The fifteenth part of the book is devoted to a detailed account of the present state of the world. It covers the period from the present time to the present time.
16. The sixteenth part of the book is devoted to a detailed account of the past state of the world. It covers the period from the past time to the past time.
17. The seventeenth part of the book is devoted to a detailed account of the future state of the world. It covers the period from the future time to the future time.
18. The eighteenth part of the book is devoted to a detailed account of the present state of the world. It covers the period from the present time to the present time.
19. The nineteenth part of the book is devoted to a detailed account of the past state of the world. It covers the period from the past time to the past time.
20. The twentieth part of the book is devoted to a detailed account of the future state of the world. It covers the period from the future time to the future time.

**RECOMMENDED READING**  
**FOR PARENTS**

**EVERYDAY PROBLEMS OF THE EVERYDAY CHILD**

By DOUGLAS A. THOM. Winner of the medal awarded by "Children" as the best parents' book of its year. \$2.50

**THE INNER WORLD OF CHILDHOOD**

By FRANCES G. WICKS. "This wise and understanding book ought to help greatly all who carry responsibility for the guidance of childhood."—*The New York Times*. \$3.00

**THE PSYCHOLOGY OF THE ADOLESCENT**

By LETA S. HOLLINGWORTH. A clear and pertinent study of the adolescent mind. \$2.50

**TALKS TO MOTHERS**

By ANGELO PATRI. A wealth of advice on child-training, drawn from Mr. Patri's wide experience with boys and girls. 50c.

**SCHOOL AND HOME**

By ANGELO PATRI. A famous schoolman tells how school and home can cooperate for the child's fullest development. \$1.50

**THE PROBLEMS OF CHILDHOOD**

By ANGELO PATRI. Ways for parents and teachers to meet the host of problems that beset childhood. \$2.00

**NUTRITION AND GROWTH IN CHILDREN**

By WILLIAM R. P. EMERSON, M.D. A practical nutrition program for home, school and community. \$2.50

**THE PSYCHOLOGY OF THE PRE-SCHOOL CHILD**

By BIRD T. BALDWIN and LORLE I. STECHER. A guide for parents in the mental and physical direction of young children. \$2.75

**D. APPLETON AND COMPANY**

New York

London

RECOMMENDED READING

FOR SALE

THE PSYCHOLOGY OF THE FEMALE

By Sigmund Freud. Translated by James Strachey. 1925. 300 pages. \$2.00.

THE INNER WORLD OF CHILDREN

By Sigmund Freud. Translated by James Strachey. 1925. 300 pages. \$2.00.

THE PSYCHOLOGY OF THE ADOLESCENT

By Sigmund Freud. Translated by James Strachey. 1925. 300 pages. \$2.00.

LETTERS TO MOTHERS

By Sigmund Freud. Translated by James Strachey. 1925. 300 pages. \$2.00.

SEXUAL AND OTHER

By Sigmund Freud. Translated by James Strachey. 1925. 300 pages. \$2.00.

THE PSYCHOLOGY OF CHILDREN

By Sigmund Freud. Translated by James Strachey. 1925. 300 pages. \$2.00.

PSYCHOLOGY AND PSYCHICS IN CHILDREN

By Sigmund Freud. Translated by James Strachey. 1925. 300 pages. \$2.00.

THE PSYCHOLOGY OF THE FEMALE CHILD

By Sigmund Freud. Translated by James Strachey. 1925. 300 pages. \$2.00.

A PSYCHOLOGY AND PSYCHICS

By Sigmund Freud. Translated by James Strachey. 1925. 300 pages. \$2.00.

